

SUSTAINABLE DEVELOPMENT STANDARDS

TABLE OF CONTENTS

1.0 PURPOSE AND APPLICABILITY

- 1.1. Purpose and Intent
- 1.2. Summary of Sustainable Development Elements
- 1.3. Administration
 - A. Pre-Application Review
 - B. Application for Development
- 1.4. Compliance Alternatives

2.0 GUIDING PRINCIPLES

3.0 SUSTAINABLE SITE DEVELOPMENT

- 3.1. Purpose and Intent
- 3.2. Efficient Buildings
 - A. Latent Energy Utilization
 - B. Windows
 - C. Natural Light
 - D. Roof Albedo
 - E. Materials
 - F. Other Sustainable Building Applications
- 3.3. Stormwater Management
 - A. Intent
 - B. Applicability
 - C. Stormwater Best Practices
- 3.4. Natural Landscaping
 - A. Intent
 - B. General Requirements
 - C. Natural Landscaping
 - D. Canopy and Shade Trees
 - E. Treatments
 - F. Infiltration on Recreation Spaces
 - G. Tree Preservation
 - H. Local Food Production
 - I. Installation of Landscape Materials

- 3.5. Efficient Parking and Access
 - A. Intent
 - B. Off-Street Parking Requirements
 - C. Parking Reduction Methods
 - D. Special Parking Types and Standards
 - E. Surface Parking Design Standards
 - F. Structured Parking Standards
 - G. Access
 - H. Parking Waiver Criteria

4.0 RESIDENTIAL DEVELOPMENT FORMS AND BUILDING TYPES

- 4.1. Applicability
- 4.2. Principles in Practice
- 4.3. General Site Improvement Standards
 - A. Site Composition
 - B. Building Orientation
 - C. Site Access
 - D. Internal Site Circulation
 - E. Parking
 - F. Open Space
 - G. Site Furnishings
 - H. Landscape and Streetscape
 - I. Transitional Buffers
 - J. Site Lighting
- 4.4. Residential Development Forms and Patterns
 - A. Purpose and Intent
 - B. Conventional Residential Development (CRD)
 - C. Diversified Residential Development (DRD)
 - 1. Open Space Residential Development (OSRD)
 - 2. Compact Neighborhood Development (CND)
 - 3. Workforce House Infill Lot (WFH)
 - 4. Residential Compound Development (RCD)
 - 5. Residential Frontage Development (RFD)
 - 6. Adaptive Reuse Residential Development (ARRD)
- 4.5. Architectural Guidelines
 - A. Building Massing
 - B. Façade Composition and Components
 - C. Historic Structures
 - D. Building Roof Forms
 - E. Building Light
- 4.6. Residential and Mixed Use Building Types

- A. Standard Single Family House
 - B. Cottage Court and Workforce Cottage
 - C. Duplex
 - D. Triplex
 - E. Multiplex (Multi-Family)
 - F. Townhouse/Rowhouse
 - G. Mixed Use Building
- 4.7. Accessory Residential Buildings
- A. Accessory Dwelling Units
 - 1. Backyard Cottage
 - 2. Carriage House Unit
 - 3. Integrated Unit
 - 4. Penthouse
 - B. Residential Development Community Buildings
 - C. Home Based Accessory Business Units
- 4.8. Signage Standards
- A. General Guidelines
 - B. Sign Harmony
 - C. Site Signage
 - D. Sign Illumination
 - E. Building Massing

IN DEVELOPMENT

5.0 COMMERCIAL/INDUSTRIAL DEVELOPMENT FORMS AND BUILDING TYPES

- 5.1. Purpose and Intent
- 5.2. Principles in Practice
- 5.3. General Site Improvement Standards
- 5.4. Industrial Development and Building Types
- 5.5. Commercial Development and Building Types

6.0 SIGNS

- 6.1. General Standards

7.0 OUTDOOR AMENITY SPACE

- 7.1. General Standards
 - A. Outdoor Amenity Space Types
 - 1. Civic Space (CS)
 - 2. Publicly Oriented Private Spaces (POPS)
 - 3. Private Open Space (PS)

7.2. Outdoor Amenity Space Design Standards

- A. Private Yard and Garden
- B. Dooryard
- C. Forecourt
- D. Community Garden
- E. Courtyard
- F. Common or Green
- G. Plaza or Square
- H. Pocket Park or Playground
- I. Athletic Field or Ball Court
- J. Neighborhood Park
- K. Streetside Terrace
- L. Rooftop Terrace
- M. Pedestrian Passage
- N. Pathway
- O. Other OAS Types

8.0 COMPLETE STREETS

- 8.1. Purpose and Intent
- 8.2. Application
 - A. Public Infrastructure Projects
 - B. Private Participation
- 8.3. Standards for All Thoroughfares
 - A. Complete Street Zones and Components
 - B. Complete Street Design and Construction Standards
- 8.4. Street Types and Design Alternatives
 - A. Applicability
 - B. Waiver
- 8.5. Vehicle Throughway Zone
 - A. Design and Construction
 - B. Travel Lanes
 - C. Bicycle Travel Facilities
 - D. Crosswalks
- 8.6. Street Enhancement Zone
 - A. Overview
 - B. On-Street Parking Lanes
 - C. Curb Extensions
 - D. Bus Facilities
 - E. Utilities

- F. Green Infrastructure
- 8.7. Furnishing & Utility Zone
 - A. Overview
 - B. Width
 - C. Surfacing
 - D. Street Trees and Tree Pits
 - E. Public Seating
 - F. Bicycle Parking
 - G. Driveway and Alley Crossings
- 8.8. Pedestrian Throughway Zone
 - A. Description
 - B. Width
 - C. Accessibility
 - D. Construction
 - E. Pavement

9.0 PUBLIC REALM ACTIVATION

- 9.1. Purpose and Intent
- 9.2. Application
 - A. Public Realm Activation Components
 - B. Activation Permits
- 9.3. Public Frontage Zones
 - A. Description
 - B. General Standards
 - C. Outdoor Café Seating
 - D. Outdoor Retail Displays
 - E. Storefront Window Displays and Signage
- 9.4. Street Enhancement Zone
 - A. Parklets
 - B. Street Banners
 - C. Tactical Urbanism
 - D. Landmarks and Public Art
 - E. Art Murals
- 9.5. Building Frontage Zone
 - A. Frontage Zone Building Placement and Orientation
 - B. Building Frontage Types and Design Standards
 - C. Ground Floor Facade Types and Design Standards
- 9.6. Frontage Encroachments

- A. Ground Signs
- B. Sandwich Board Signs
- C. Projecting Banners and Blade Signs
- D. Marquee Signs
- E. Storefront Awning
- F. Balcony
- G. Bay Windows
- H. Arcade
- I. Gallery

10.0 GLOSSARY OF TERMS

DRAFT

FIGURES

FIGURE 1.1 - CONTEXT-BASED DESIGN AND DEVELOPMENT

FIGURE 1.2 – DEVELOPMENT REVIEW PROCESS

FIGURE 3.3.1 – BIORETENTION

FIGURE 3.3.2 – BIOSWALE

FIGURE 3.3.3 - PERVIOUS PAVEMENT

FIGURE 3.3.4 - GREEN STREET DESIGN AND STORMWATER PLANTERS

FIGURE 3.3.5 - GREEN ROOFS AND WALLS

FIGURE 3.4.1 - INFILTRATION PARKS AND PLAZAS

FIGURE 3.5.1 - TANDEM AND STACKED PARKING

FIGURE 3.5.2 - STREET SIDE PARKING (ON FRONT PROPERTY LINE)

FIGURE 3.5.3 - EXAMPLES OF WELL LANDSCAPES PARKING LOTS AND SHADE TREES

FIGURE 3.5.4 - EXAMPLES OF STRUCTURED PARKING AND FRONTAGE UTILIZATION

FIGURE 4.3.1 – ILLUSTRATIVE EXAMPLES OF SITE COMPOSITION

FIGURE 4.3.2 – ILLUSTRATIVE EXAMPLES OF BUILDING ORIENTATION

FIGURE 4.3.3 – ILLUSTRATIVE EXAMPLES OF SITE CIRCULATION

FIGURE 4.3.4 – ILLUSTRATIVE EXAMPLES OF PARKING PLACEMENT AND DESIGN

FIGURE 4.3.5 – ILLUSTRATIVE EXAMPLES OF LANDSCAPE AND STREETScape DESIGN

FIGURE 4.3.6 – TRANSITIONAL LANDSCAPE AND BUILDING BUFFER

FIGURE 4.4.1 - EXAMPLE OF CONVENTIONAL AND DIVERSIFIED RESIDENTIAL DEVELOPMENT

FIGURE 4.4.2 – EXAMPLE OF OPEN SPACE RESIDENTIAL DEVELOPMENT (OSRD)

FIGURE 4.4.3 – ILLUSTRATIVE EXAMPLE OF COTTAGE COURTS (CND-CC)

FIGURE 4.4.4 – EXAMPLE OF TRADITIONAL NEIGHBORHOOD DEVELOPMENT (CND-TND)

FIGURE 4.4.5 – EXAMPLE OF COHOUSING DEVELOPMENT (CND-CD)

FIGURE 4.4.6 – ILLUSTRATIVE EXAMPLE OF A RESIDENTIAL COMPOUND (RCD)

FIGURE 4.4.7 – ILLUSTRATIVE EXAMPLE OF A RESIDENTIAL FRONTAGE DEVELOPMENT (RFD)

FIGURE 4.4.8 – EXAMPLE OF A RESIDENTIAL ADAPTIVE REUSE DEVELOPMENT (AARD)

FIGURE 4.4.9 - OPEN SPACE RES. DEVELOPMENT & COMPACT NEIGHBORHOOD DEVELOPMENT STANDARDS

FIGURE 4.4.10 - ALLOWED BUILDING TYPES IN DIVERSIFIED RESIDENTIAL DEVELOPMENTS

FIGURE 4.5.1 – ILLUSTRATIVE EXAMPLES OF ARCHITECTURAL APPLICATION

FIGURE 4.6.1 - STANDARD SINGLE FAMILY HOUSE DESIGN GUIDELINES

FIGURE 4.6.2 - COTTAGE COURT AND WORKFORCE COTTAGE DESIGN GUIDELINES

FIGURE 4.6.3 - DUPLEX DESIGN GUIDELINES

FIGURE 4.6.4 - TRIPLEX BUILDING DESIGN GUIDELINES

FIGURE 4.6.5 - MULTIPLEX BUILDING DESIGN GUIDELINES

FIGURE 4.6.6 – TOWNHOUSE/ROWHOUSE DESIGN GUIDELINES

FIGURE 4.6.7 - MIXED USE BUILDING DESIGN GUIDELINES

FIGURE 4.7.1 - DESIGN GUIDELINES FOR ACCESSORY DWELLING UNITS

FIGURE 4.7.2 - DESIGN GUIDELINES FOR COMMUNITY BUILDINGS IN RESIDENTIAL DEVELOPMENTS AND HOME BASED BUSINESSES

TABLE 4.8.1 – ILLUSTRATIVE EXAMPLES OF SIGN DESIGN

SIGNS

TABLE 4.1 - OUTDOOR AMENITY SPACE TYPES AND DESIGN STANDARDS

FIGURE 5.1 - COMPLETE STREET ZONES AND COMPONENTS

FIGURE 5.2 - COMPLETE STREET TYPES AND DESIGN OPTIONS

FIGURE 5.3 - PEDESTRIAN CROSSWALK DESIGN STANDARDS

FIGURE 5.4 - STREET ENHANCEMENT ZONE

FIGURE 5.5 - CURB EXTENSION DESIGN STANDARDS

FIGURE 5.6 - FURNISHING & UTILITY ZONE

FIGURE 5.7 - STREET TREE PLANTER DESIGN STANDARDS

FIGURE 5.8 - RECOMMENDED ELEMENTS OF A MODULAR SUSPENDED PAVEMENT SYSTEM

FIGURE 5.9 - ILLUSTRATIVE EXAMPLES OF PUBLIC SEATING

FIGURE 5.10 - PUBLIC SEATING ORIENTATION

FIGURE 5.11 - BICYCLE PARKING DESIGN STANDARDS

FIGURE 5.12 - DRIVEWAY AND ALLEY CROSSING DESIGN STANDARDS

FIGURE 5.13 - PEDESTRIAN THROUGHWAY ZONE

FIGURE 5.14 - PEDESTRIAN THROUGHWAY DESIGN STANDARDS

FIGURE 6.1 – ACTIVATION OF THE OUTDOOR ROOM

TABLE 4 - PUBLIC REALM ACTIVATION COMPONENTS

FIGURE 24 - PUBLIC FRONTAGE ZONE

FIGURE 25 - OUTDOOR SEATING CAFÉ DESIGN STANDARDS

FIGURE 26 - ILLUSTRATIVE EXAMPLES OF CAFÉ SEATING

FIGURE 27 – OUTDOOR RETAIL DISPLAYS

FIGURE 28 - PARKLET DIAGRAM

FIGURE 29 - ILLUSTRATIVE EXAMPLES OF PARKLETS

FIGURE 30 - ILLUSTRATIVE EXAMPLES OF TACTICAL URBANISM

FIGURE 31 - ILLUSTRATIVE DIAGRAM OF PUBLIC ART INSTALLATION

FIGURE 32 - BUILDING LOT FRONTAGE ZONE

FIGURE 34 – BUILDING FAÇADE ORIENTATION AND CORNER SETBACK

FIGURE 35 - VERTICAL & HORIZONTAL FACADE MODULATION AND ARTICULATION

FIGURE 36 – BUILDING FAÇADE ELEMENTS

FIGURE 37 - GROUND AND UPPER FLOOR TRANSPARENCY

FIGURE 38 - EDGE BUILDING FRONTAGE DESIGN STANDARDS

FIGURE 39 - FORECOURT BUILDING FRONTAGE DESIGN STANDARDS

FIGURE 40 - ARCADE BUILDING FRONTAGE DESIGN STANDARDS

FIGURE 41 - GALLERY BUILDING FRONTAGE DESIGN STANDARDS

FIGURE 42 - FRONT PLAZA AND SEATING TERRACE DESIGN STANDARDS

FIGURE 43 - STOREFRONT FACADE DESIGN STANDARDS

FIGURE 44 - OFFICEFRONT FACADE DESIGN STANDARDS

FIGURE 45 - CIVIC FACADE DESIGN STANDARDS

FIGURE 46 – SANDWICH BOARD SIGNS

FIGURE 47 – BLADE AND BANNER SIGNS

FIGURE 48 – MARQUEE SIGNS

FIGURE 49 – STOREFRONT AWNINGS

FIGURE 50 – BALCONIES

FIGURE 51 – BAY WINDOWS

FIGURE 52 – ARCADES

FIGURE 53 – GALLERIES

DRAFT

1.0 PURPOSE AND APPLICABILITY

1.1 PURPOSE AND INTENT

The Winchendon Planning Board adopted the Winchendon Sustainable Development Standards in (DATE) in accordance with MGL Chapter 40A to supplement the development review process as part of the Planning Board Rules and Regulations. These development and design guidelines are intended to be used by the Planning Board for all eligible development projects under the Winchendon Zoning Bylaw, Article 12 - Site Plan Review.

The purpose of the Sustainable Development Standards is to establish the minimum requirements and expectations for the quality of design for development and investment in the Town of Winchendon. Applicants are encouraged, but not required, to achieve beyond the scope of these standards and guidelines in each sustainability category.

Any development that requires Site Plan or Special Permit approval administered by the Planning Board is required to follow the Sustainable Development Standards. Adherence to the Sustainable Development Standards helps applicants to achieve approval and may accelerate the review process. The standards also establish a framework for site plan review by the Planning Board.

The Planning Board's broad intention in adopting the Sustainable Development Standards is to maintain and/or improve the quality of life of Winchendon residents, the value of property and the viability of commerce districts through the use of context-based design and sustainable development practices. The Sustainable Development Standards and review process encompass a range of topics and aspects of site planning and design. This requires the collaboration of multiple disciplines and perspectives such as architecture, landscape architecture, civil engineering, urban design, and community planning to achieve a meaningful, economically viable, environmentally sustainable, and aesthetically pleasing site plan.

1.2 SUMMARY OF SUSTAINABLE DEVELOPMENT ELEMENTS

The Sustainable Development Standards contains Private Realm and Public Realm components. For example, Private Realm design standards address site access, parking placement, landscaping and screening, stormwater management, building placement, frontages and façade treatments, outdoor amenity spaces, and other site design elements. Public Realm design standards address street design, streetscape treatments, on-street parking, pathways, utilities, and related elements.

In any vibrant neighborhood, village center, or commercial/industrial district, there is a strong, supportive relationship between private development and public spaces such as streets and open spaces. In particular, the transitional areas in pedestrian-oriented districts are critical such as the placement, orientation, and access to buildings in relationship to streets and sidewalks. The Sustainable Development Standards are intended to reinforce the strong relationship between the Private Realm and Public Realm with the understanding that there’s an investment to be made and benefit to be realized by the developer as well as the Town.

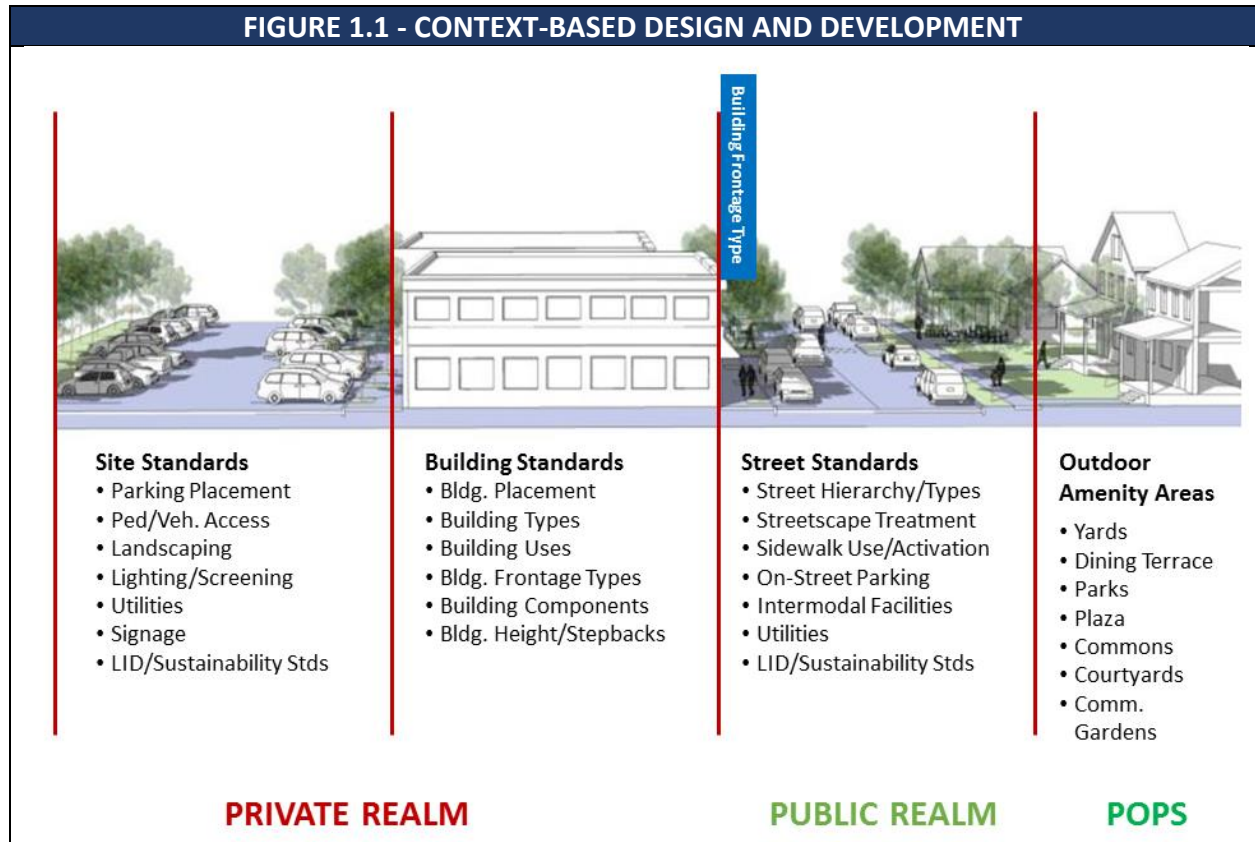

1.3 ADMINISTRATION

Winchendon property owners are strongly encouraged to use the Sustainable Development Standards when planning and designing potential renovations, redevelopment, or new buildings of their properties. Any significant change to an existing building or property will likely require site plan review with the Planning Board. Town staff will review preliminary plans and applications for compliance with the Winchendon Zoning Bylaws and consistency with these Sustainable Development Standards prior to submitting a formal application. Once a formal application is submitted, Town staff will review the plans and prepare a report with recommendations for the Planning Board consideration.

A. Pre-Application Review.

Applicants are encouraged to meet with town staff prior to submitting a formal development application to the Planning Board and its formal review. During the pre-application phase, both site and building designs can be discussed as they relate to the Sustainable Development Standards. The objective is to provide an open discussion and a mutual understanding of both the development opportunities and challenges posed by a particular site and development program. This type of dialogue can enhance the efficiency of the approval process and outline design directions that are mutually beneficial to the Town and applicant. At any point in the process, the Winchendon Planning Development is available for permitting guidance and assistance.

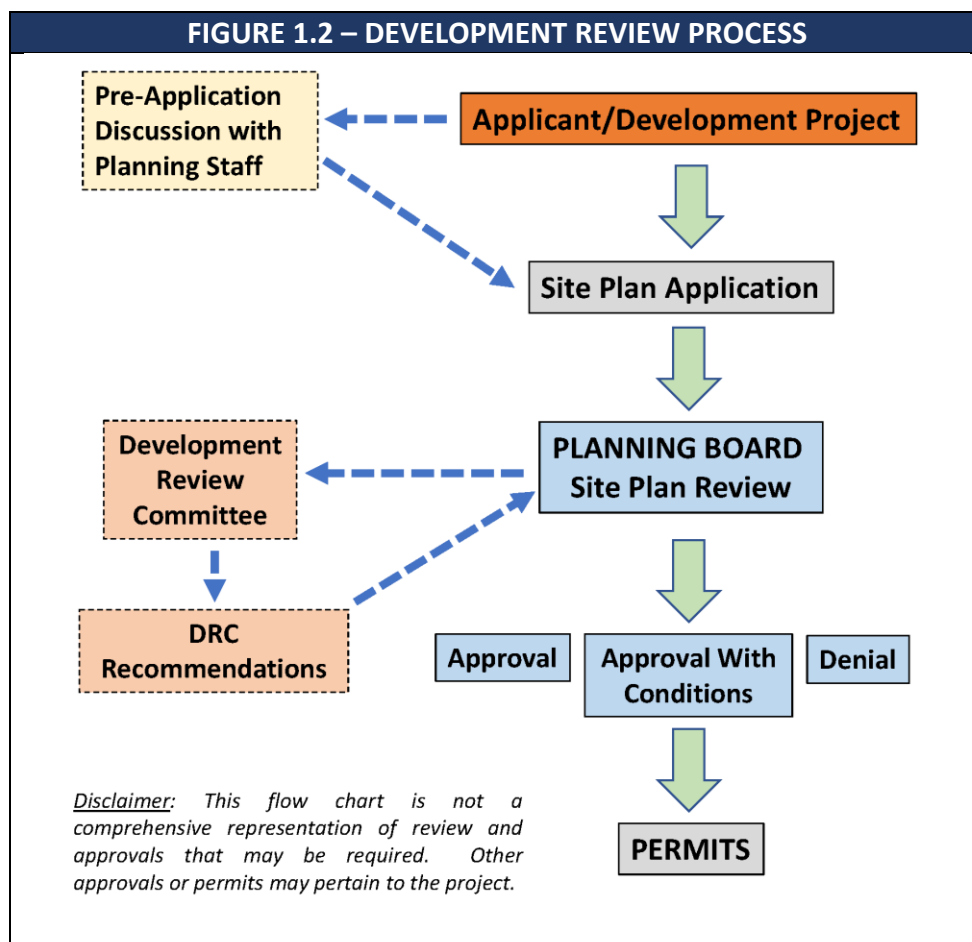

Commentary: Is there/should there be a Development Review Committee (DRC) for the purpose of reviewing conceptual or preliminary site plan applications? Maybe representatives of Planning, ED, DPW, Building, Land Use, and selected committees?

B. Application for Development.

Development review is initiated by the Planning Board upon receipt of a Site Plan or Special Permit Application. The Planning Department will provide an initial review, according to a Sustainable Development Standards Checklist. This review determines the areas of focus for discussion between the applicant and the Planning Board. The Planning Board and applicant then meet to discuss the development and its compliance with the Sustainable Design Standards. The planning staff presents final written recommendations to the Planning Board.

1.4 COMPLIANCE ALTERNATIVES

It can be difficult for Sustainable Development Standards to predict all possible site planning and design scenarios, or anticipate new trends, technologies or best practices. If specific sustainability standards will not be followed by an applicant because they feel a better approach to reinforcing the Town's sustainable community principles exists for their individual development and design circumstances, a compliance alternative may be reached as an agreed upon method to comply with the intention of the Standards. This option provides a process to arrive at innovative design solutions that all parties agree will follow the intent of the Standards. The applicant must specifically identify the areas in which they seek a compliance alternative with a Compliance Alternative Request Form, and the Planning staff provides an opinion and recommendation regarding the alternative approach in writing to the Planning Board. Please contact the Winchendon Planning and Development Department for further information.

2.0 GUIDING PRINCIPLES IN PRACTICE

These guiding principles reflect Winchendon's goals and aspirations for a sustainable community today and for future generations. These sustainability principles are consistent with the 2020 Winchendon Community Master Plan, 2021 Municipal Vulnerability and Hazard Mitigation Plan, 2015 Open Space and Recreation Plan, and [Housing Needs Assessment/Production Plan \(Year\)](#).

SUSTAINABLE GROWTH AND DEVELOPMENT

Development projects should strive to address the highest ecological principles by protecting and enhancing the overall health, natural environment, and quality of life of Winchendon. Air, water, light, and land pollution should be minimized. Both site design and construction of buildings should result in efficient use, reuse, and recycling of resources, including energy, water use, and construction materials. The Planning Board highly favor projects that intend to seek certification under the Leadership in Energy and Environmental Design (LEED) Green Building Rating System and the LEED-Neighborhood Development Rating System™.

Low Impact Development (LID) techniques should be used to reduce the concentration of stormwater runoff and maintain existing stormwater flows. Where feasible, bioswales, rain gardens and other bioretention techniques should be employed. Green roofs and rain storage systems are encouraged in order to reduce and reuse roof drainage. Pervious paving materials should be used where feasible to reduce runoff from hardscaped areas and integrated into the design of the project.

COMPACT DEVELOPMENT AND HUMAN SCALE DESIGN

Encourage compact development in order to promote a more efficient use of land, reduce dependency on personal vehicles for travel, and reduce the costs of providing public infrastructure and services. Development should be designed for the human scale, considering the relationship between the dimensions of the human body and the proportion of traveled ways, public spaces, and buildings. Site design should consider how various site features enhance pedestrian mobility, safety, comfort, enjoyment, and walking distance to other off site amenities. The design of buildings, streetscapes, signs, open spaces, and other features should be determined based on what will create a pleasant environment for the pedestrian.

MIXED USES AND FLEXIBLE BUILDING SPACE

Designated areas of Winchendon should include a mixture of residential, commercial, and civic uses at a scale appropriate for the community. Mixed use development can be an important sustainability tool in certain residential and commercial districts by including a mix of housing types and sizes to accommodate households of a broad range of ages, sizes, incomes and physical

abilities. Mixed use can also reduce personal vehicle use, promote health, and expand economic opportunities. To encourage vibrant commercial districts and dynamic neighborhoods, housing may be appropriate adjacent to or above commercial uses such as shops or offices forming a “Live, Work, Play” district.

ARCHITECTURAL CONTEXT AND ADAPTIVE REUSE OF HISTORIC STRUCTURES

In Winchendon Town Center and older neighborhoods, new buildings should be designed to reflect traditional New England “village” architecture such as Greek Revival, Georgian, Colonial Revival, Shingle, and Stick. Architecture should also be varied but compatible in scale. Existing historic buildings should be renovated and rehabilitated for adaptive reuse as a first resort is structurally and economically viable. Contemporary design in selected non-historic residential, commercial, and industrial districts may be appropriate and encourage to reflect modern technology and innovation as a component of the community.

NEIGHBORHOOD PRESERVATION AND EXPAND HOUSING CHOICES

A broad range of housing choices at moderate density in Winchendon should be provided. Housing may also be appropriate in selected commercial and industrial districts to support local business in terms of customers and employment base. Increased housing choices can be incorporated in a variety of development forms such as cottage courts, open space residential developments, housing cooperatives, townhouses, rowhouses, multi-family buildings, mixed-use development, and accessory dwelling units. These building types and development forms should also provide a positive transitional between commercial districts and surrounding neighborhoods. Convenient pedestrian and vehicular connections should be provided between districts by a network of streets, sidewalks, bikeways, crosswalks, and trails. At the same time residential areas should be protected from unwanted traffic, visual intrusion, and negative impacts to the pace and scale of their environments.

ACTIVE OPEN AND CIVIC SPACE

New development should contribute to the successive increase of private and publicly-oriented open spaces within Winchendon. Active and shared outdoor spaces should be a major element of any development plan, providing a clear purpose of social and community interaction, and fostering participation in civic activities. The type and distribution of Outdoor Amenity Spaces should be coordinated with municipal facilities such as the Winchendon Rail Trail, GAR Park, and other existing and future open and civic spaces across Winchendon.

QUALITY LANDSCAPE AND STREETScape CHARACTER

Landscaping and streetscaping should be arranged in such a way as to act as a unifying element between buildings, sidewalks, streets, pathways and public spaces. Special attention should be given to street trees which in general should be located between curb and sidewalk and should

be continuous along all primary and secondary streets. Landscaping should complement the scale of a development project and its surroundings. In general, larger, well-placed contiguous planting areas are preferred to smaller, disconnected areas. Open spaces should be integrated throughout a development project with an emphasis on functionality – such as providing a comfortable, shaded place to sit – and not simply aesthetic appeal.

MULTI-MOBILITY IN TRANSPORTATION NETWORK

An interconnected network of circulation systems that facilitate walking, bicycling, and driving is a sustainability goal in Winchendon. Streets should be designed to establish a satisfactory level of service for vehicular travel and promote the safe and efficient use of different transportation modes. A connected street pattern should limit the need for dead-end streets in order to create multiple routes for pedestrians, bicyclists, and motorists. Streets should incorporate “traffic calming” techniques, such as differentiated paving, smaller turning radii, and/or street trees, to slow traffic speed and promote pedestrian safety. New development projects should implement traffic mitigation best practices to enhance walking, bicycling, ride-sharing, car sharing and public transit as a viable alternative to personal vehicles.

ECONOMIC OPPORTUNITY

New commercial and industrial development should expand and diversify the Winchendon economy through new business development and job creation. Sustainable economic development requires flexibility in order to fulfill market opportunity and business diversity while requiring high quality design and development.

3.0 SUSTAINABLE SITE DEVELOPMENT

3.1 PURPOSE AND INTENT

- A. To facilitate best practices in site design including sustainable stormwater management techniques, landscaping, and low impact development.
- B. To ensure energy saving building features are properly designed and appropriately installed which encourage the passive cooling of interior spaces and reduce the need for electrical air conditioning; protect circadian rhythms and enhance the happiness and productivity of building occupants by visually connecting them with the outdoors and introducing natural daylight into interior spaces; and minimize heat island impacts on the urban environment.

3.2 EFFICIENT BUILDINGS

All buildings in Winchendon should strive to achieve a zero net energy goal of 100% through best practices in design and construction practices such as governed by the Energy Star Program and the U.S. Green Building Council LEED Rating System.

- A. Latent Energy Utilization (Solar/Geothermal).** The energy naturally existing within a site is its latent energy. In the northeast, this is most often in the form of solar energy coming from the sun, and geothermal energy in the form the stable temperature of the ground despite seasonal temperature swings. The use of solar thermal and solar photovoltaic techniques is highly encouraged. Massing of buildings should be considerate of solar access to neighboring properties, particularly allowing sun during winter to properties immediately to the north.
 - 1. Whenever possible buildings should be of a size and orientation to minimize the blocking of sunlight on public spaces such as sidewalks.
 - 2. Windows should be oriented to make the best use of passive solar heating.
 - 3. The primary roof plane should face as close to solar south as possible, to allow for installation or retrofit with solar panels.
 - 4. Gable roofs and shorter buildings may be more appropriate on the south sides of a street while gable end roofs and taller buildings may be more suited for the north side.
- B. Windows.**
 - 1. At least fifty percent (50%) of the windows of each floor of a building and serving each dwelling unit should be operable.

2. Operable windows should be oriented toward prevailing winds to every extent possible and support the creation of cross breezes that can assist in the passive cooling of interior spaces.
3. All south facing windows should be recessed or shaded by deciduous trees, awnings, canopies, or interior or exterior light shelves.
4. If installed, shutters should be functional, sized to provide complete coverage of the window when closed, and include appropriate hardware to keep them secured when open or closed.

C. Natural Light. The following apply to multi-family and commercial buildings:

1. A minimum of fifty percent (50%) of the floor area of all regularly occupied interior spaces should receive sufficient daylight equal to a spatial daylight autonomy of three hundred (300) lux or more for at least fifty percent (50%) of the time.
2. A direct line of sight to the outdoors should be provided for at least seventy-five percent (75%) of the floor area of all regularly occupied interior spaces.

D. Roof Albedo.

1. Flat roofs and roofs pitched at or below nine and one-half degrees (9.5°; 2:12) should have a minimum solar reflectance index rating of seventy-eight (78) for a minimum of seventy-five percent (75%) of the roof surface.
2. Roofs pitched above nine and one-half degrees (9.5°; 2:12) should have a minimum solar reflectance index rating of twenty-nine (29) for a minimum of seventy-five percent (75%) of the roof surface.

E. Materials.

1. High-quality, Locally Sourced Materials. The durability and aesthetic value of a material is intrinsically related to its quality. Choosing high-quality materials ensures that the buildings last. Locally sourced materials offer an additional layer of benefits in the form of stimulating the local economy, reducing the energy involved in transportation, and being a product of the area.
2. Recyclable, Low Embodied Energy Materials. The carbon footprint of a material is a product of the cumulative amount of energy invested in it over its lifespan, including the harvesting of raw materials, refinement, production, transportation, and disposal. Choosing materials that require lower levels of energy at each stage of this process can substantially lessen its environmental impact. If the product is designed to be recycled, this reduces the energy needed to harvest raw materials in its next iteration.

3. Environmentally and Historically Appropriate Materials. Exterior cladding and detailing should be chosen for its ability to work with the local climate and resist degradation. Materials should be honest about the time in which they are employed.
4. Texture, Variation and Tactility. Natural materials such as wood and stone are good materials, as they read as monolithic from a distance but revealing variations in tone and texture as one moves closer towards them. Finding the correct number of materials for the façade of a building is a balancing act: too few and a building can look uninteresting and stark; too many and it can appear overstimulating and busy.

F. Other Sustainable Building Applications. Applicants are encouraged to use other sustainable practices to improve building envelope energy efficiency and to use materials and equipment that reduce energy consumption in Winchendon such as the following:

1. Natural cooling through appropriate glazing, shading of glazed surfaces, and operable windows.
2. Wind and roof-mounted solar energy generation.
3. Ground source heat exchange (closed system geothermal energy).
4. On-site biomass use for energy production.
5. Renewable heat and cooling (i.e. sunlight, rain, wind).
6. Combined heat and power systems.
7. Green walls and green blocks.
8. Increased insulation (i.e. R-26 and triple-glazed windows)
9. Energy Star rated appliances.
10. EcoStar Program (shared recycling streams between park tenants).
11. Dual-flush and waterless toilets.
12. Ultra-efficient heat and hot water systems.
13. Open and simple floor plans (i.e. square and cubes).
14. Improved building air seal (i.e. taped sheathing).
15. Greywater systems.

3.3 STORMWATER MANAGEMENT

A. Intent.

The stormwater management measures proposed for site development shall conform with the **Winchendon General Codes, Section XXX** – Stormwater Management, and to the best management practices described in the Commonwealth of Massachusetts Stormwater Management Handbook, as may be amended from time to time. The intent of this sections is the following:

1. To promote stormwater management practices that maintain pre-development hydrology through site design, site development, building design and landscape design techniques that infiltrate, filter, store, evaporate and detain stormwater close to its source;
2. To protect water resources and other natural aquatic systems on the development site and elsewhere from degradation that could be caused by construction activities and post-construction conditions;
3. To protect other properties from damage that could be caused by stormwater and sediment from improperly managed construction activities and post-construction conditions on the development site;
4. To reduce the impacts on surface waters from impervious surfaces such as streets, parking lots, rooftops and other paved surfaces; and
5. To promote public safety from flooding and streambank erosion, reduce public expenditures in removing sediment from stormwater drainage systems and natural resource areas, and to prevent damage to municipal infrastructure from inadequate stormwater controls.

B. Applicability.

1. Consistent with stormwater management best practices, new development projects should maintain or achieve pre-development hydrology through sustainable site design techniques that infiltrate, filter, store, evaporate and detain storm water close to its source.
2. The post-construction peak runoff rate for the one-year, twenty-four (24) hour rain event shall not exceed the existing peak runoff rate for the same storm event from the site under existing conditions prior to submittal of an application. Low Impact Development (LID) practices as identified below should be incorporated into the design as necessary to achieve the required runoff rate. If constraints prevent the use of these LID practices,

other stormwater treatment best practices detailed in the Commonwealth of Massachusetts Stormwater Management Handbook may be used to achieve the required post construction runoff rate.

C. Stormwater Best Practices

1. Minimization of Impervious Surface: Impervious surface shall be minimized by: providing only as much parking as required by **Article 8** of the Zoning Bylaw; using short and narrow driveways, permeable paving, green rooftop systems, and low impact development techniques as described in references such as the Massachusetts Executive Office of Environmental Affairs LID homepage in current versions wherever possible (<http://www.mass.gov/envir/lid/default.htm>).
2. District Stormwater System: When an entire district or large scale development is planned at once, one storm water management system may be developed to manage the whole development. Increased runoff in one area can be balanced by greater infiltration in another, through incorporation into a collective District Stormwater System which results in the reduction in release rates and runoff volumes.
3. Light Imprint Site Layout: Light imprint applications shall integrate hydrology and storm water management into site design using existing conditions to influence the location and layout of roadways, buildings, and parking areas. Buildings and roadways should be placed in areas less sensitive to disturbance, and the storm water management system design should create a symbiotic relationship between the development and natural hydrology. The attention to natural hydrology and nonstructural storm water management creates a more attractive, multifunctional landscape.
4. Filter Strips and Bioretention: Filter strips are bands of densely vegetated slopes, designed to reduce water runoff volume and improve water quality prior to entering storm water drainage basins. Filter strips are typically designed to break up impervious surfaces (such as parking lots) and provide initial storm water treatment by filtration. They also provide infiltration of water, reducing the overall amount of runoff. Filter strips shall be incorporated into roadway and parking lot designs.

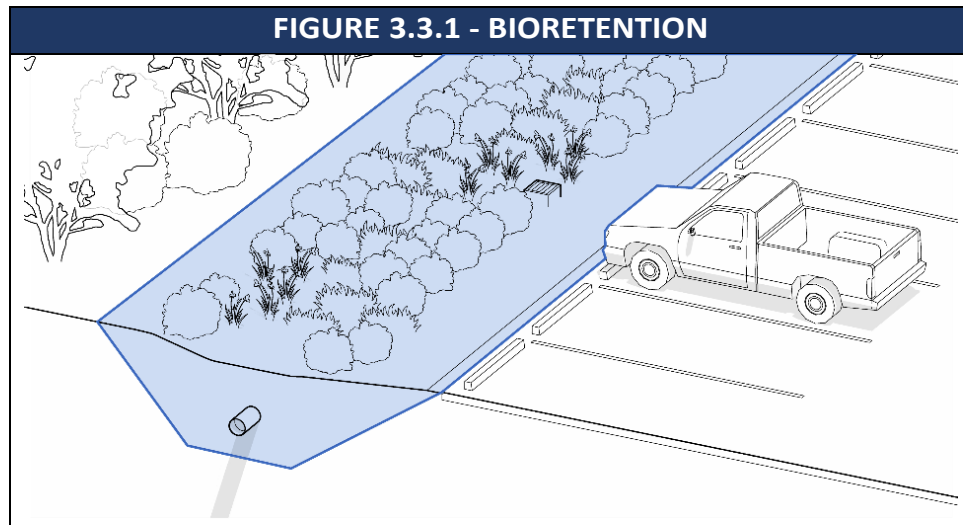

5. **Vegetated Swales (Bioswales)**. Vegetated swales are broad, shallow channels designed to convey and infiltrate storm water runoff. Swales are to be used as a preferred alternative to closed, non-infiltrating drainage systems. The design of swales should seek to reduce storm water volume through infiltration, improve water quality through infiltration and vegetative filtering, and reduce runoff velocity by increasing flow path lengths and channel roughness.

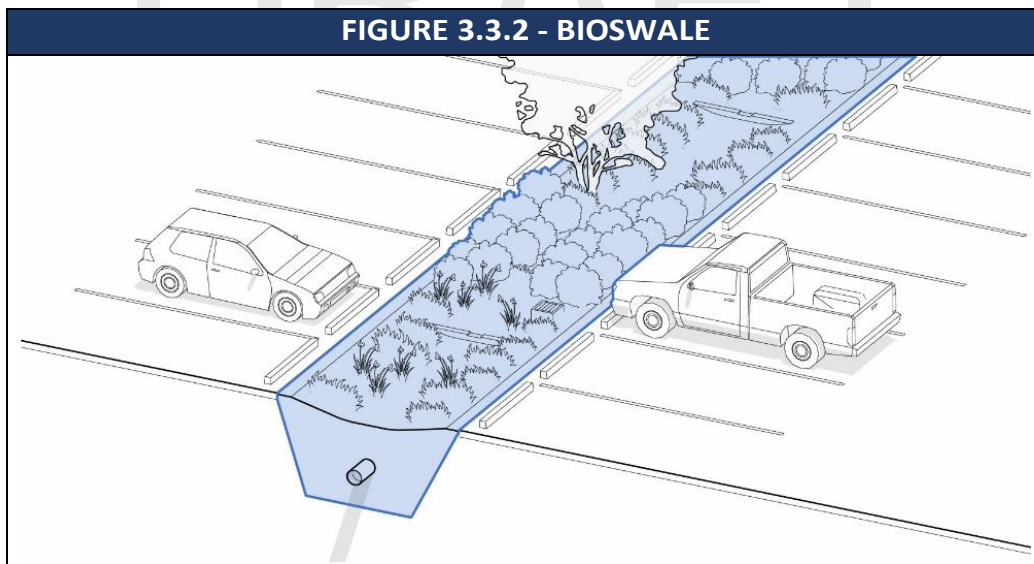

6. **Bioretention Cells (Rain Gardens)**. Rain gardens (also known as bioretention cells) are vegetated depressions that store and infiltrate runoff. Rain gardens are designed to encourage vegetative uptake of storm water to reduce runoff volume and pollutant concentrations. A well designed rain garden has an engineered soil, which maximizes

infiltration and pollutant removal while avoiding storm water ponding for longer than 24 hours. Combined with filter strips, bioretention cells are important components of the LID treatment process and are incorporated into roadway and parking lot designs.

7. Pervious Pavement. Permeable paving reduces stormwater runoff volume, velocity and pollutants by allowing water to infiltrate into the sub-surfaces below parking areas. They are generally appropriate for low-traffic parking lots. They can be incorporated as a hybrid parking lot, which uses conventional paving for driveways and aisles, and permeable paving for parking stalls. Permeable paving may also be appropriate for overflow parking areas, which are generally used only a few weeks out of the year. Maintenance of pervious pavements is critical to maintain the permeability.

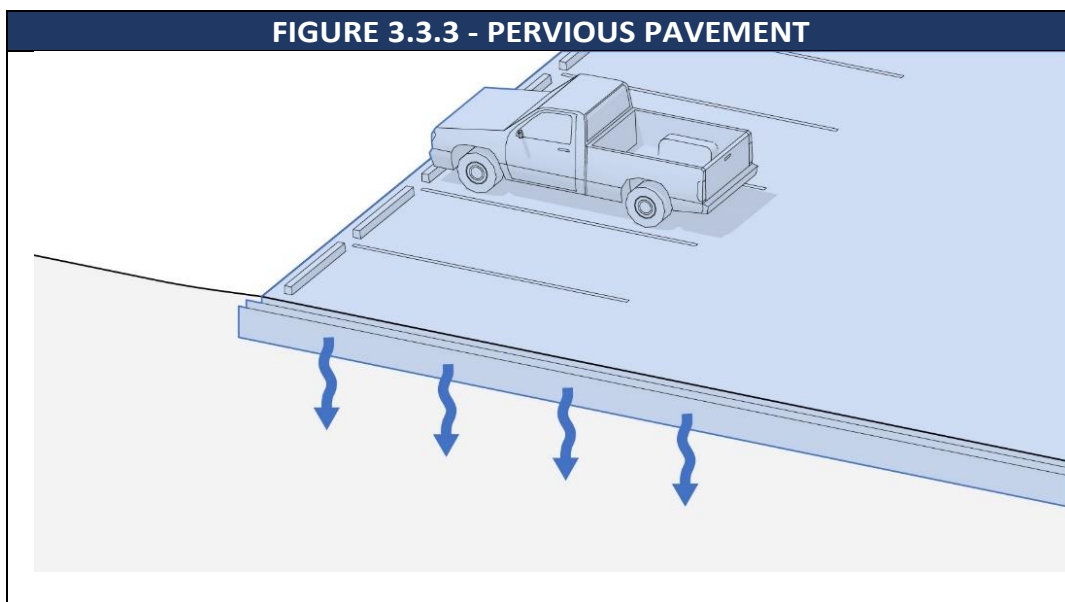

8. Subsurface Retention Facilities (Stormwater Vaults). Subsurface retention facilities are typically constructed below parking lots (either permeable or impervious) and can be built to any depth to retain, filter, infiltrate, and alter the runoff volume and timing. This practice is well suited to higher density sites with open space constraints. Subsurface facilities can provide a considerable amount of runoff storage. The water is filtered through the stone aggregate and infiltrates into the ground. An alternative strategy is to construct the subsurface facility with a filtering and pumping mechanism so that collected water can be reused for non-potable uses such as irrigation or flushing of toilets. Similar techniques include gravel storage galleries, sand filters, infiltration basins, and infiltration trenches (for areas with space constraints).

9. Green Streets and Stormwater Planters. Green streets are thoroughfares that capture, temporarily store, and treat road runoff at its source by incorporating vegetated water catchment and filtration devices in the form of small rain gardens and bioretention systems. Components such as flow-through planters and other sustainable storm water solutions allow stormwater from the street to enter planters through cuts in the curb where the plant material removes impurities and allows water to naturally infiltrate or be stored elsewhere. Water-loving plants and those that are able to remove the impurities while thriving so close to traffic and in more urban environments are used in green street design, adding beauty and function. Additional infiltration can be achieved using pervious paving materials for sidewalks and streets.



10. Downspout Redirection. Building downspouts are commonly directly connected to centralized sewer or stormwater systems. A LID design application is to redirect roof runoff onto pervious surfaces, most commonly a lawn. This simple act reduces the amount of directly connected impervious area in a drainage area.
11. Rain Barrels/Cisterns. Rain barrels should be placed outside of a building at roof downspouts to collect and store rooftop runoff, which can later be reused for lawn and garden watering.
12. Green Walls and Roofs. Green Roofs capture rainwater on the roofs of buildings to support plantings that reuse the water, reducing the overall amount of runoff leaving the roof. The plants and the soil they are growing in provide additional insulation for the building. Roof drains should be recharged into the site with the use of structural and/or non-structural low impact development drainage systems. Green Walls should be

designed to provide habitat, mitigate afternoon and seasonal heat gain, and re-introducing indigenous plants to the site.

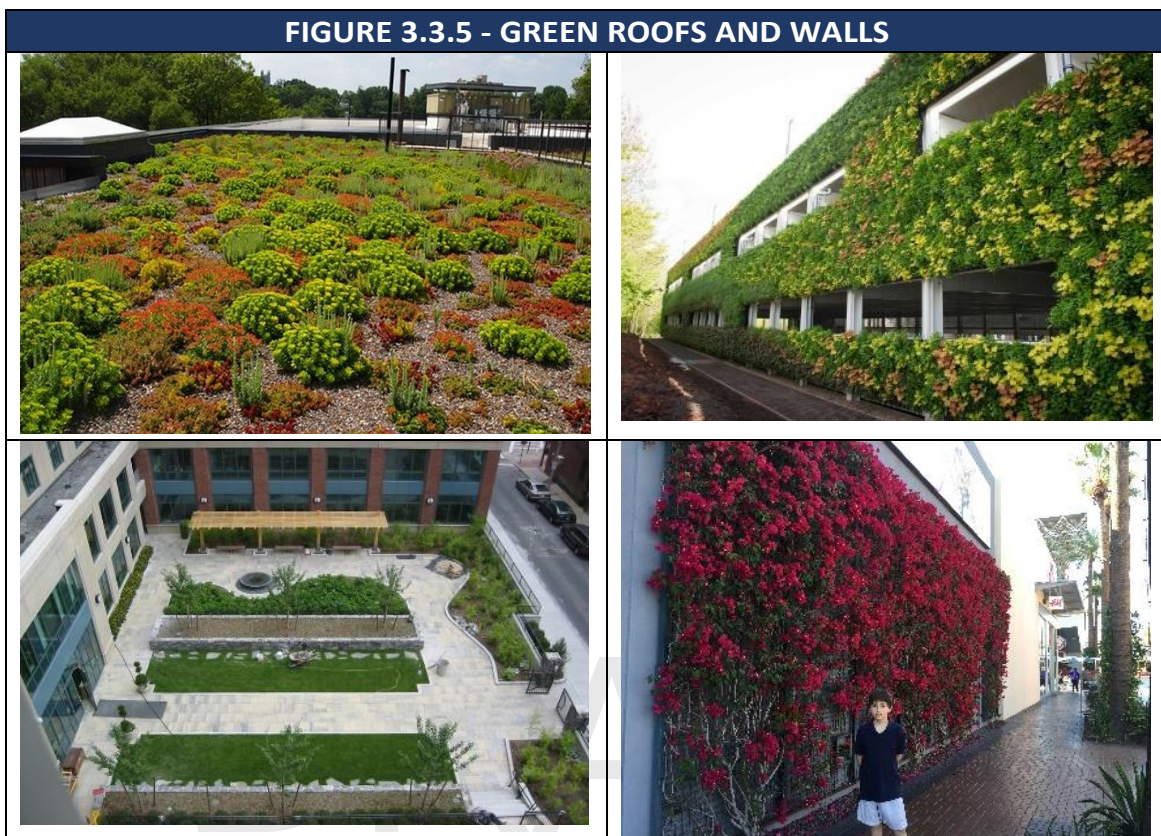

3.4 NATURAL LANDSCAPING

A. Intent. To protect water quality in Winchendon through natural landscaping and best practices in pavement management and infiltration.

B. General Requirements.

1. To the greatest extent possible, existing native trees and shrubs (vegetation that grows naturally in particular climates or regions) shall be maintained.
2. No tree, shrub or plant shall be used that has been identified as an Invasive Species by the Massachusetts Plant Advisory Group in the most recent version of *The Evaluation of Non-Native Plant Species for Invasiveness in Massachusetts* (with annotated list,) or has been identified as invasive or banned on the *Massachusetts Prohibited Plant List* as periodically updated by the Massachusetts Department of Agriculture.
3. Existing invasive plants shall be removed.

C. Natural Landscaping.

1. Natural landscaping with plants native to local climate and soil conditions are required. These plants thrive naturally, requiring less maintenance and irrigation than most hybrid or imported varieties.
2. Natural landscaping should be used to minimize the need for irrigation systems and improve planting longevity. Preserving existing wooded areas, mature trees, and natural terrain can give new development a premium "mature landscape" appearance and provide residents with additional recreational amenities.
3. Plant materials should be selected for their form, color, and texture, as well as solar, soil, and moisture requirements. It is also recommended that native plants be used because of their performance, site enhancement, and life-cycle cost benefits.

D. Canopy and Shade Trees. The broad use of canopy trees is a simple and attractive solution to reducing heating and cooling needs for buildings and sites. When planted on the south and west sides of buildings, shade trees keep buildings cool in summer and then drop their leaves during the cooler fall season allowing warming sunlight on buildings. Canopy trees also provide sunlight on parking lots in the winter and shade in the summer while absorbing rainfall which reduces the amount of stormwater.

E. Treatments. The use of fertilizer is discouraged.

F. Infiltration on Recreational Spaces. This form of bio-retention allows rainwater to be temporarily captured and stored for a short time, cleaning storm water runoff before infiltration. Public and private parks and open spaces should function as part of the stormwater system where applicable. Surrounding areas can be graded so that the rainwater flows towards the parks. Creating a gradual and imperceptible depression allows water to collect in the park and stay there long enough to infiltrate without giving the appearance of a stormwater facility that should store water for no more than 24 hours.

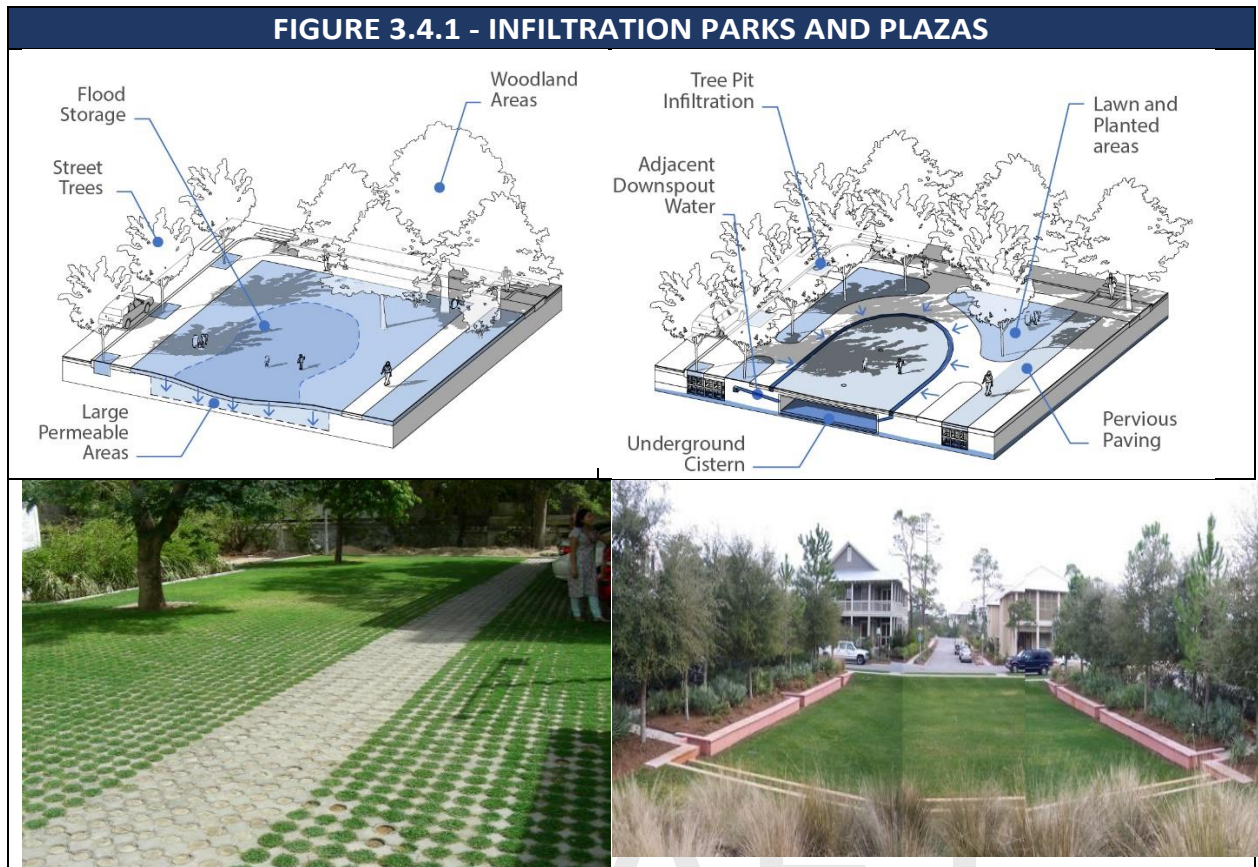

G. Tree Preservation. Preservation of existing, on-site trees and other vegetation is the preferred means for landscaping. Mature, healthy trees and vegetation may be used to fulfill landscape requirements of the **Zoning Bylaw, Article XXX**. Existing trees may be counted as required trees provided that:

1. The tree is at least four (4) inches in diameter at breast height (DBH).
2. The tree is determined to be in good health and not damaged, diseased, or a threat to public health or safety.
3. Invasive plant species to the State of Massachusetts must be removed from the site.

H. Local Food Production. To support conservation, self-sufficiency, improved nutrition, and reduced food expenses, the Town of Winchendon encourages small scale agriculture to strengthen the local food system. Some techniques include the following:

1. **Community Gardens:** See Outdoor Amenity Spaces in **Section XXX**.
2. **Edible Landscapes:** The utilization of plants and landscaping that produce edible food in settings that conventionally have been limited to ornamental or nonfood producing plants.

I. Installation of Landscape Materials.

1. **Plant Species:** Landscape should consist primarily of native species requiring minimal irrigation, fertilization, and maintenance. Plantings must be cold hardy, drought tolerant, and able to survive on natural rainfall once established with no loss of health.
2. **Planting Areas:** Must have uncompacted coarse loam that is a minimum of twelve (12) inches deep. Soils must be appreciably free of gravel, stones, rubble, or trash. All compacted soil, contaminated soil, or road base fill must be removed.
3. **Spacing:** The spacing and placement of plants must be adequate and appropriate for the typical size, shape, and habit of the plant species at maturity.
4. **Minimum Cover:** A minimum of two (2) kinds of landscape cover is required, including but not limited to trees, shrubs, permeable and pervious pavers, and turf grass.
5. **Ground Stabilization:** Bare and exposed ground on a site and/or in required landscaped areas must be stabilized and maintained with turf grass, ground cover, or mulch to prevent soil erosion and allow water infiltration, with the exception of the following:
 - a) Land area dedicated to urban agricultural activities, as permitted;
 - b) Trails;
 - c) Naturally occurring stream beds, rock outcroppings, and similar features typically lacking in vegetation; and
 - d) Clay or sand surfaces associated with recreation fields and facilities.

3.5 EFFICIENT PARKING AND ACCESS

- A. Intent.** In addition to **Article 8** of the Winchendon Zoning Bylaws, these parking standards provide best practice alternatives that the Planning Board may consider when granting site plan approval or parking waivers for placement and number of spaces to the requirements under Article 8, with the following intent:
1. To minimize the impact of sidewalk interruptions and conflict points on the walkability of the public realm.
 2. To ensure adequate parking for existing and new development while minimizing excessive and inefficient off-street parking lots that result in lost opportunities to develop new buildings that expand local business and the tax base.
 3. To encourage the use of public transportation, ride sharing, car sharing, bicycling, and walking as an alternative to personal motor vehicles when a choice of travel mode exists.

- B. Off-Street Parking Requirements.** Any parking spaces in excess of the given standards in **Section 8.4** is discouraged and the need for additional parking spaces must be clearly demonstrated.
- C. Parking Reduction Methods.** The Planning Board may grant a waiver for the reduction of off-street parking in the **Section 8.4 (ITE Parking Ratio Table is in the Appendices)** by employing one or more of the following best practices:
1. Shared Parking and Mixed Use.
 - a) A combination of uses on-site using shared parking lots with offset peak demand times where: a shared parking agreement with proximate properties where uses have offset peak demand times; uses have a high rate of parking turnover; or evidence of similar uses and location situations operating successfully with lower amounts of parking.
 - b) Where shared parking is proposed, the Planning Board may require an evaluation prepared by the applicant following the procedures of the Urban Land Institute (ULI) Shared Parking Manual (latest edition) or the Institute of Transportation Engineers (ITE) Shared Parking Guidelines (latest addition), or other approved procedures determined by the Planning Board.
 - c) A formal parking evaluation may be waived for small developments where there is established experience with the land use mix and its impact is expected to be minimal.
 2. Car-Sharing Program. The Planning Board may approve a parking reduction where an active car-sharing program is made available to residents and/or employees of a development site; and where the car-share facility is on site or within a 700-foot walking distance of the site.
 3. Off-Site Parking. The Planning Board may allow required parking to be provided off-site for employees, except for any required handicapped parking, as permitted according to the provisions of and when conforming to the following:
 - a) A lot featuring the off-site parking must be located within seven hundred (700) feet in walking distance, measured from the nearest point of the off-site parking along walkways to the principal building entrance served;
 - b) Pedestrian access between the use and the off-site accessory parking area must be via paved sidewalk or walkways; and

- c) A lease, recorded covenant, or other comparable legal instrument, executed and filed with the Town of Winchendon, guaranteeing long term use of the site is provided to the Planning Board.

D. Special Parking Types and Standards.

1. Stacked and Valet Parking. The Planning Board may grant a waiver to allow valet or stacked parking if an attendant is present to move vehicles. If stacked parking is used for required parking spaces, a written guarantee must be filed with the Town ensuring that an attendant will always be present when the lot is in operation. The requirements for minimum or maximum spaces continue to apply for stacked parking. Valet and stacked parking spaces do not require individual striping and may be permitted on-site or off-site as a means of satisfying the applicable off-street parking requirements where:
 - a) Adequate assurance of the continued operation of the valet parking is provided.
 - b) An equivalent number of valet spaces are available to replace the number of required off-street parking spaces.
 - c) The design of the valet parking area will not cause queuing in a vehicular travel lane.
 - d) An attendant is provided to park vehicles during business hours.
2. Tandem Parking. The Planning Board may grant a waiver to allow tandem parking under the following conditions:
 - a) To be used to meet parking requirements for residential units only.
 - b) Tandem spaces shall be assigned to the same dwelling unit.
 - c) Tandem parking shall not be used to provide guest parking.
 - d) Two parking spaces in tandem shall have a combined minimum dimension of 9 feet in width by 30 feet in length.
 - e) Up to 75% of the total off-street parking spaces provided may be incorporated into tandem parking.

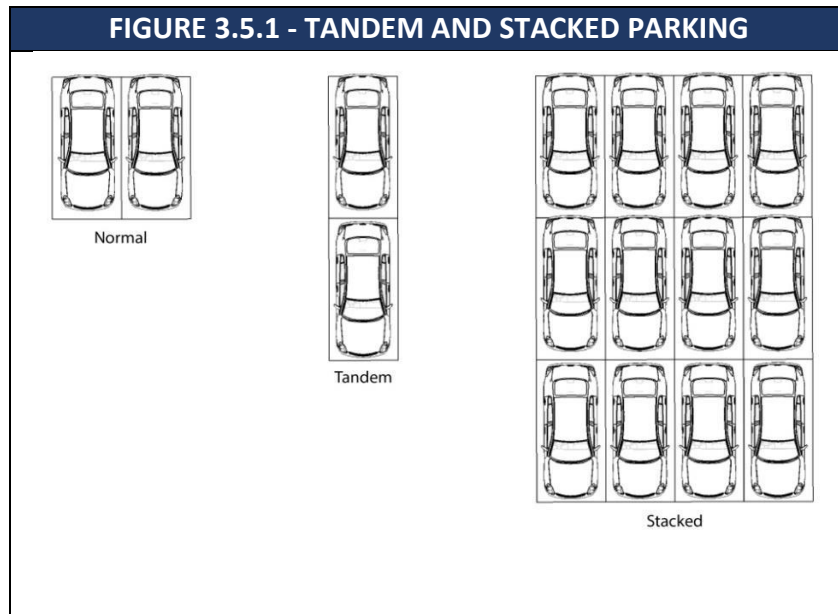

3. Street Side Parking. The Planning Board may grant a waiver to allow parallel parking provided on a privately-owned lot directly **fronting on Central Street and side streets between Front Street and Maple Street, an on Front Street from Lake Street and River Street** adjacent to the public right-of-way in combination with a minimum five (5) foot wide planting strip with street trees planted 40 feet on center, and eight (8) foot minimum concrete sidewalk connecting to public sidewalks on abutting lots and to the primary building on-site. These parking spaces shall be 8 feet wide by 22 feet long; accessible for public use; and effectively function as on-street parking.

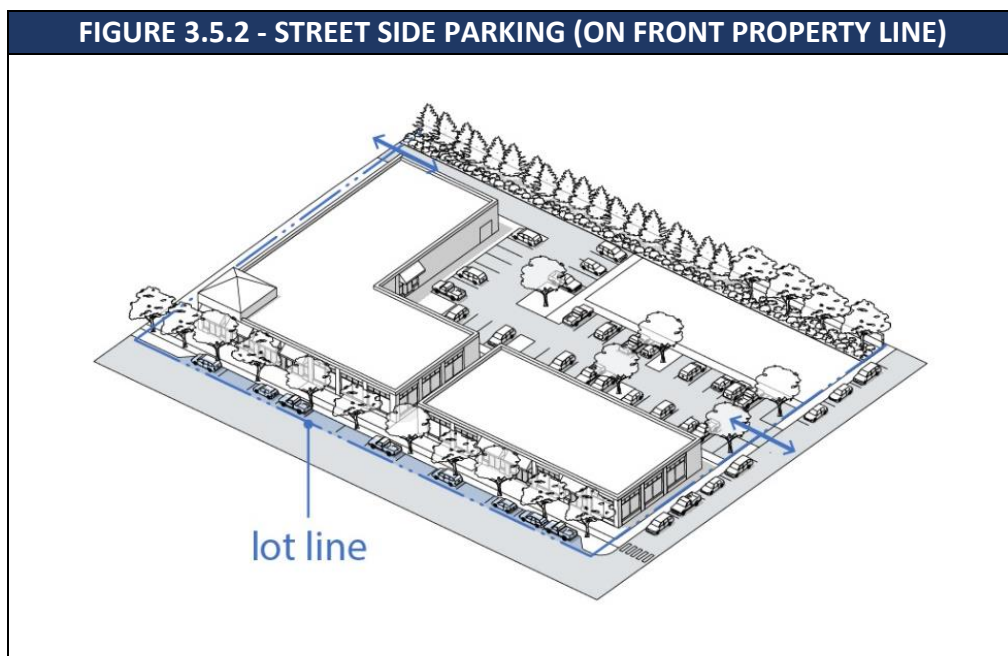

E. Surface Parking Design Standards.

1. Placement. Off-street parking lots should be placed to the side and rear of commercial, industrial, and mixed use buildings.
2. Pedestrian Access. Pedestrian access from a parking lot must connect directly to a public sidewalk and to the primary building.
3. Common Driveway. Shared driveway access from a public street to adjacent properties is permitted and encouraged wherever possible.
4. Shared Vehicle Access. Shared internal access and utilization of parking spaces on separate lots is permitted and encouraged.
5. Pervious Materials. Off-street parking lots may be surfaced with pervious materials to allow stormwater to permeate the ground below. See Section 3.3 above.

FIGURE 3.5.3 - EXAMPLES OF WELL LANDSCAPES PARKING LOTS AND SHADE TREES



F. Structured Parking Standards.

1. Permitted Types. Off-street parking structures may include a surface garage or carport, an above-ground parking structure, or an underground parking structure.

FIGURE 3.5.4 - EXAMPLES OF STRUCTURED PARKING AND FRONTAGE UTILIZATION

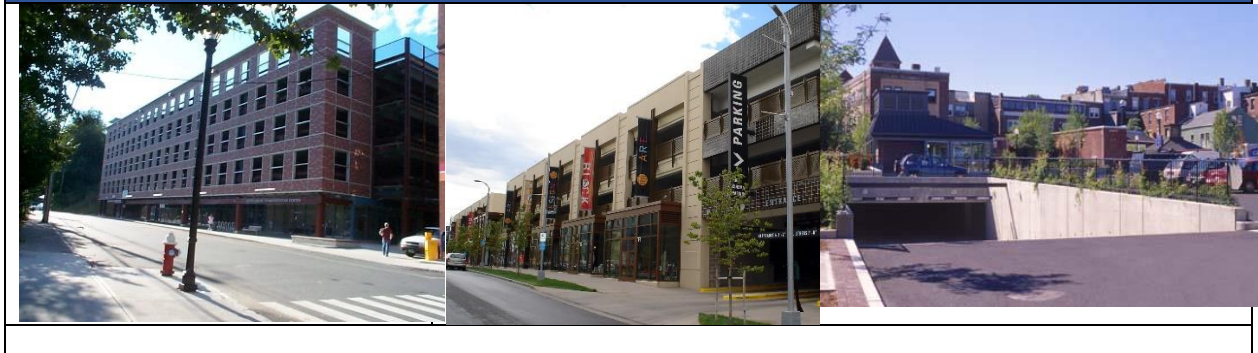

2. **Access.** Pedestrian access to structured parking shall be made directly to the primary building and to a public sidewalk as applicable. Structured parking may be attached directly to the primary building allowing pedestrians to enter directly into the building. Parking structures may be shared by multiple properties to meet off street parking requirements.
 3. **Design and Construction.** Where a structured parking facility is visible from a public street, the design of the visible façade(s) must be meet the follow standards:
 - a) Facade door and window openings must be vertically and horizontally aligned and all floors on the front side of facade facing the street must be level (not inclined).
 - b) The facade must include windows of transparent or translucent, but non-reflective, glass or openings designed to appear as windows for between twenty percent (20%) and fifty percent (50%) of the wall area of each floor.
 - c) Windows must be back-lit during evening hours and internal light sources must be concealed from view from public sidewalks.
 - d) The facade area masking the floors occupied by motor vehicle parking must be seamlessly integrated into the architectural design of the building's facade.
 4. **Commercial Use.** The ground level and top level may be used for commercial purposes.
- G. Access.** Driveways serving 2 or less dwelling units shall be a maximum of 16 feet in width but may be increased or reduced with the approval of the Planning Board. Driveways serving commercial, industrial, civic, mixed use, and multifamily buildings and development shall be no greater than 24 feet in width. The Planning Board may grant waivers for driveway widths when pervious surfaces are being used.
- H. Parking Waiver Criteria.** Where a waiver is sought for relief from the parking standards, the Planning Board shall consider the following:
1. The supply and demand of public and private parking in the district, as determined through a parking study.
 2. Transportation and mobility management programs and services provided by the applicant to reduce the demand for parking.
 3. That parking provided in excess of the minimum requirement does not result in underutilized spaces, excessive impervious surfaces, and lost opportunities for building or outdoor amenities spaces.

4.0 RESIDENTIAL DEVELOPMENT FORMS AND BUILDING TYPES

4.1. APPLICABILITY

These design standards are applicable to residential developments under the Winchendon Zoning Bylaw including Article 11 - Residential Development. These design standards are also intended to guide municipally sponsored residential development, Chapter 40B Comprehensive Permits, and other residential developments sponsored by non-profit housing and community development organizations.

4.2. PRINCIPLES IN PRACTICE

The design and development of new high quality residential communities is a goal of the Town of Winchendon. The combination of a sustainable site layout, quality building design, and active outdoor amenity spaces creates a vibrant residential community that is a benefit to residents and provides a competitive advantage in the market. These residential development and design standards provide specific recommendations for larger scale residential development, and residential uses that require a Special Permit or approval at Town Meeting with the intention of reinforcing the traditional New England community character of Winchendon. For applicable residential developments, the following principles apply:

- A. Development site composition that reinforces the human scale of the built environment with buildings that are relatable to the pedestrian and a walkable site design with inviting streetscapes or small community open spaces for socializing and gathering.
- B. Building architecture that is varied and eclectic in style that echoes traditional New England design characteristics with traditional details, materials, and colors.
- C. Cluster smaller residential buildings together on smaller lots and around common space, while preserving larger contiguous tracts of open space.
- D. Arrangement of larger buildings around a common open space that is framed by paths, small streets, or natural landscapes.
- E. For larger buildings, employment of additive building massing that suggests evolution or modification over time through organic, incremental growth. For example, the classic New England connected farmhouse.

4.3. GENERAL SITE IMPROVEMENT STANDARDS

The following guidelines outline the site design and layout practices that should be viewed as baseline components of a well-designed residential development in the Town of Winchendon.

- A. **Site Composition.** A residential development's site planning and design should provide a responsive approach to the natural conditions of the land and adapt the development program and site elements to the attributes and constraints of the property.

1. Cluster Arrangement. Site design should be used to reinforce the sense of a New England village environment with clustered buildings that reinforce a sense of community.
2. Frame Views and Spaces. Site and building layouts should frame purposeful clearings, enhance desirable views and reinforce privacy between residential buildings.
3. Integrate Natural Site Features. The site design should take advantage of the natural site features by maintaining, incorporating, or adapting the inherent characteristics of the property (topography, landscape features and vegetation, rock formations, stone walls, etc.) to guide and benefit the layout and design of the site.
4. Create Compact Development Footprint. Site and building components should be clustered to maintain the maximum amount of natural and undisturbed open space on the property. Natural site features, such as mature trees, groves, and woodland buffers, should be retained as part of the residential development to benefit the site layout and surrounding community.
5. Reduce Impact of Parking. Site layout should be designed to minimize the visibility and impact of parking, service, and utility-oriented functions of the property. Parking should be provided in smaller areas distributed among residential buildings and by means of on-street parking or parking in driveways.
6. Share Open Space. Use common open space as a design feature in the layout of building clusters.

FIGURE 4.3.1 – ILLUSTRATIVE EXAMPLES OF SITE COMPOSITION

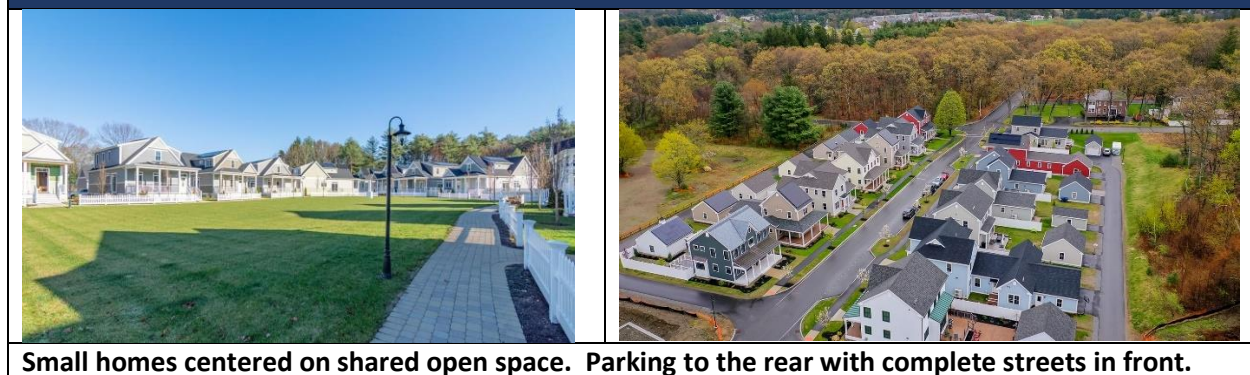

- B. Building Orientation.** For larger-scale residential development, buildings should be used to organize the site, reinforce a sense of neighborhood, frame open space, and conceal parking and service areas.
1. Orient Building to Street and Open Space. Primary building facades should be oriented to the street frontages and/or common open spaces that in turn are bordered by

development streets. An alternative pattern is to provide access streets to the rear of the building and frontages would be directly onto a common pathway and open space.

2. Relate Buildings to Each Other. A development that includes multiple residential buildings should orient the buildings to address each other and to frame street frontages and common open spaces.
3. Respect Patterns of Context. Building setbacks should be consistent with the design standards in Section 4.5 Residential Building Design and consider the pattern of buildings in the context of the surrounding residential community. Where there are adjacent buildings, the setbacks should be similar to reinforce the rhythm and pattern of the neighborhood.
4. Vary Building Relationships. Variation between buildings and the manner in which they frame open spaces should occur to create distinct relationships between buildings and common open spaces.
5. Conceal Parking with Buildings. Buildings should be oriented so that surface parking and garages are concealed in secondary locations and are not the primary visual focus of the development.

FIGURE 4.3.2 – ILLUSTRATIVE EXAMPLES OF BUILDING ORIENTATION



C. Site Access. Site access should provide clear and legible routes for all modes of transportation including pedestrians, bicycles, vehicles, and public transportation where available. These “Complete Streets” should connect to the site to the public street system, and internal site circulation systems.

1. Minimize Site Access. The number and width of vehicular access points into and out of the site should be minimized. Pedestrian crossings should be marked and differentiated with variations in paving materials such as stamped concrete or painted asphalt. Refer to the Chapter 175 - Winchendon Subdivision Regulations and the Department of Public Works for additional requirements as part of the street permitting process.

2. Connect to Public Frontages. Sidewalks or pathways should be provided along any and all internal street frontages and along the site perimeter frontages. Additionally, sidewalk and paths should be provided linking street frontages to all building entries.

D. Internal Site Circulation. Circulation internal to the site should provide clear and legible routes for all modes of transportation to connect to the streets, building entries, and other site components.

1. Complete Circulation System. A complete access system for all modes of transportation, pedestrians, bicycles and vehicles, should be integrated into the site design. The vehicular street network should provide connecting routes between adjacent parcels as appropriate to enhance connectivity within the Town.
2. Promote Pedestrian Circulation. Internal site vehicular circulation routes should be designed with traffic calming, such as narrow travel lanes and marked pedestrian crossings, to slow vehicular traveling speeds and reinforce a safe and welcoming pedestrian environment. Pedestrian crossings should be marked and differentiated with variations in paving materials such as stamped concrete or painted asphalt.
3. Enhance Pedestrian Connectivity. Sidewalks should be provided along all street frontages at the site perimeter. Sidewalk paths should be provided on new streets within the site, linking public frontage street(s) to building entries. Existing footpaths on the site should be accommodated and integrated into the site circulation to provide access across or through the site. Site circulation that contributions to connectivity of existing trail systems (i.e. Winchendon Rail Trail and others) should be integrated into the site access and circulation and be a part of the residential community amenities.
4. Integrate Bicycle Circulation and Connections. Access, circulation, and safety for cyclists on site including pathways, pavement markings, bicycles racks near community amenity spaces and multifamily buildings, and other amenities.
5. Create Efficient Parking and Circulation. Shared driveways should be used for adjacent residences. Efficient parking and access configurations should be employed that minimize repetitious infrastructure and impervious surfaces. Clustered infrastructure and access should be used to reinforce clustered building patterns.



- E. Parking.** Parking should be conveniently near building entrances while maintaining pedestrian access, safety, and aesthetics of the site. Parking is necessary to support the function of a residential development, but it should not be viewed as utilitarian only. Parking should be integrated with other site amenities that support a sense of community. Specific parking requirements are in Article 8 of the Zoning Bylaw.
1. Minimize Parking Location and Orientation. For residential developments with a garages, the garage door should not be located on the primary building façade or street frontage. On secondary building facades, the location and design of garage doors should be integrated with the design of the façade so that the garage door is not the prominent feature of the façade.
 2. Distribute Parking Areas. Where feasible, parking areas should be distributed on the site in a central location or in multiple smaller parking areas for larger developments. Parking areas should be integrated within the building layout and site amenities to reduce the overall visual impact of parking on the residential community. Distributed parking areas should be located to the rear and side of buildings with access provided by primary streets or rear access streets.
 3. Create On-Street Parking in Pockets. On-street parking is encouraged in pockets and integrated within the overall site circulation and landscape plan. Information on-street parking may also be appropriate with wider streets. Where parking pockets are located near a residential building, they should be of a material other than asphalt to reinforce the appearance of a parking space.
 4. Provide Visitor Parking. Visitor parking should be provided for a residential development beyond that required for unit parking. Visitor parking should be located in a central area convenient to most units or near common open space.

5. Reinforce Parking Screening. When adjacent to a common open space or residential building, parking should be screened from view through the use of trees, landscape beds, and/or low fences or stone walls.
6. Integrate Parking Landscape. Large parking areas should be broken into smaller areas by means of landscaped islands containing low plantings and deciduous trees. Such islands should be placed at regular intervals across the parking lot to reduce the visual impact of the parking area and to reinforce a more pleasant pedestrian environment.



F. Open Space. Residential development projects should provide common open space integrated within the overall site plan design. Several characteristics of this type of open space are important to the character and quality of the residential community. (See Section 6.0 - OUTDOOR AMENITY SPACES for specific types of Outdoor Amenity Spaces and design standards).

1. Define Public and Private Space. In a residential development creating clear and distinct boundaries between public space and private space is very important. This can be accomplished through the configuration of buildings, paths, fences, and landscape.

2. Design Common Open Spaces and Amenities. In the context of the residential development, common open space, is open space that is shared by the residential community. It is an amenity and resource shared among residential units of the development but is not considered a public open space. Depending on the scale and use of the common open space, this area could include natural park areas, small pedestrian plazas, playgrounds, community gardens, outdoor seating, landscape, trails, community buildings, and other amenities.
 3. Create Private Open Space. In addition to common open space, private open space should also be provided in a residential development. These spaces would be dedicated for use by a single unit with clear boundaries and potentially associated with ownership, leases or deed restrictions. Private open spaces could include yards, gardens, greenhouses, patios, terraces, decks, porches, balconies, and other amenities.
 4. Consider Public Open Space. Different from a common open space, a Public Open Space would be accessible to the public for community use beyond the residential development.
 5. Create Open Space Connections. Common or Public open spaces should also link to existing or proposed trails or pathways in and around the property, creating a network of connected open spaces and walking routes.
- G. Site Furnishings.** Site furnishings should enhance community activity and serve to enhance the resident's experience. Site furnishing may include benches, trash and recycling receptacles, bike racks, fire pits, picnic benches and shelters, gazebos, playground equipment, exercise stations, and other components appropriate to the use and scale of the development.
1. Coordinate Location of Furnishings. Site and open space furnishings should be located as appropriate to level of activity and site use in higher activity areas that are most likely to receive use.
 2. Coordinate Design of Furnishings. The character and design of the site amenities selected should be consistent with the overall character of the site and building design.
 3. Integrate Furnishings. Site amenities should be integrated with the site design to allow appropriate clearances, space, and circulation around them to allow busy areas to function appropriately.
- H. Landscape and Streetscape.** Residential development should include a hierarchy of landscape that contributes to the overall site design and integrates with adjacent properties as applicable. Refer to the **required list of species in Section XXX of the Site Plan Rules and Regulations that are drought tolerant, native to New England, and non-invasive**).
1. Define Entry and Gateway Landscape. Entry and gateway landscape should be used to define site access and reinforce a sense of arrival to the residential community. The

gateway landscape may be integrated with signage throughout the residential development. This type of feature should be simple and balanced within the overall development.

2. Integrate General Site Landscape. Development site landscape should be used to provide privacy, frame views, and reinforce a sense of New England character by defining edges and clearings.
3. Coordinate Scale of Landscape. Selection of the type and maturity of plantings should be carefully considered relative to the overall scale of the development and individual buildings. New plantings should be selected for reasonable maturity at the time of installation to achieve a more rapid appearance of fullness.
4. Define Building Landscape. Building landscape should be used to integrate the buildings into the overall site plan, soften building edges, and enhance public sidewalks, building entries, and any common open spaces and community buildings.
5. Create a Layered Landscape. Building landscape should be used to establish zones of privacy for residential units with a pattern of plantings and landscape design that reinforces the interconnectivity between streets, buildings, private open spaces, and common spaces.
6. Highlight Featured Spaces. At locations that are significant in the overall site design such as community amenities, the landscape should be used to reinforce the importance of this site component. An additional number of plantings, unique composition or variation in planting species, scale, or plant species with special seasonal variation should be used to reinforce common site features.
7. Provide Landscape Screening and Buffers. Landscape should be used to integrate and conceal dumpsters, recycling areas, and other equipment or service uses from view by residential units or pedestrian areas. Additional landscape buffering should be provided where the property abuts another type of use to reinforce the distinction between the properties.
8. Coordinate Landscape at Street Frontages. Streetscape for site frontages on public or private ways should contribute to the character of the community and reinforce a consistent street context that is integrated within the character, type and spacing of adjacent landscape improvements. A tree belt should be located on both sides of the street separating the travel lanes from the sidewalk, and deciduous street trees should be planted in a regular pattern. Where applicable, the center of cul-de-sacs should also be landscaped with a combination of trees and landscape beds. The landscaping along public street frontages should respect and reflect the character of Scenic Roads where designated.
9. Integrate Functional Features into the Landscape. Stormwater retention areas should be integrated within the site landscape and treated as a naturalized environment.

These site features should be sustainable from a plant material and maintenance perspective. Retaining walls, fencing, guardrails and other utilitarian or screening features should be integrated with the overall landscape design and contribute to the overall site character. Functional site features should be designed, and consideration should be given to views from adjacent properties.

10. **Integrate Functional Features and Materials.** The materials used for functional features, such as retaining walls, drainage structures or other required site elements, should be integrated within the overall site design and material palette. For example, a functional retaining wall should include stone facing to reflect the traditional New England Character of the town.



- I. **Transitional Buffers.** Along the perimeter of the lot or development tract abutting residentially zoned and occupied properties, the Planning Board may determine that certain buildings and uses may need to be buffered to create a compatible transition with the surrounding neighborhoods.
 1. **Landscape Buffer.** Where required, buffers may include a combination of natural or landscaped screening and fencing that provides an opaque visual barrier to a minimum height of six (6) feet above the ground.

2. **Building Buffers.** Where required, primary residential and mixed use building height at the side or rear yard setback line should be 25 feet with increasing height permitted on a 45-degree plane further setback from the tract boundary to the maximum height allowed by the Building Type.

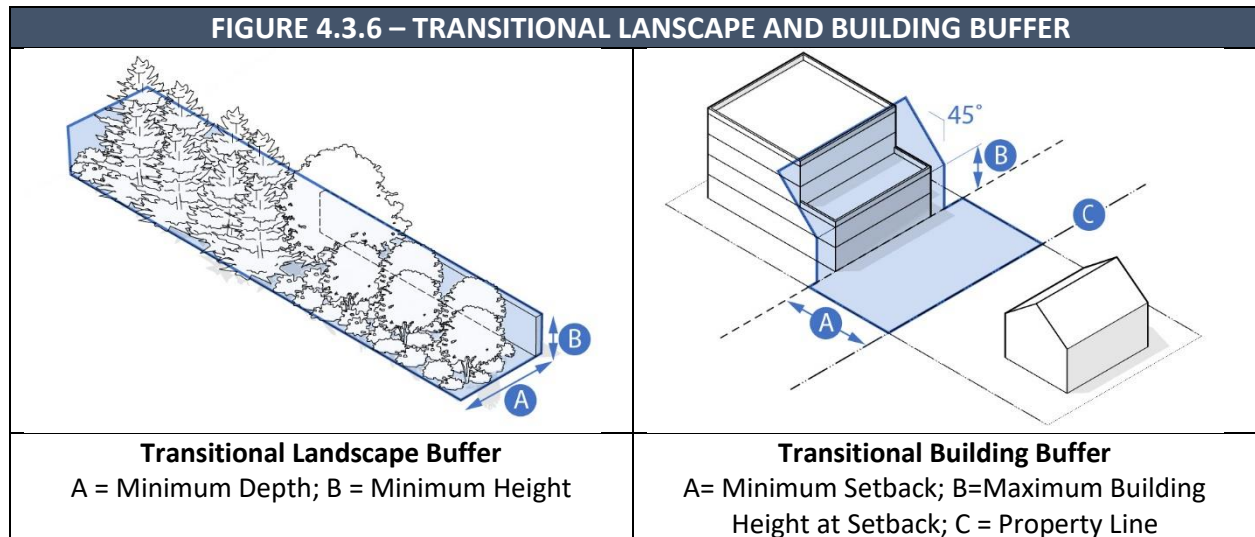

- J. Site Lighting.** Site lighting is intended to provide safety in areas with evening activity, particularly near street and building entries, across parking lots, and on paths and open spaces. The minimum level of lighting for nighttime safety should be provided. Lighting design must comply with the requirements in Section 135-5.4 of the Zoning Bylaws.
1. **Minimize Lighting.** Site lighting must meet the minimum lighting standards but not provide lighting in excess of requirements. Downward-directed, dark-sky compliant lighting should be provided to minimize excess glare and spillage off the development site.
 2. **Integrate Lighting Fixtures within the Overall Design.** Lighting fixtures should be selected to contribute to the overall character of the streets, buildings, and consistent with the overall design and sense of community.
 3. **Create Multiple Layers of Site Lighting.** Site lighting should perform multiple functions for multiple areas and users. Site lighting should be designed for vehicles, pedestrians, building entry areas, and site features. Each of these multiple areas should be designed in coordination and to complement the overall character of the site.
 4. **Define Entry, Gateway and Feature Lighting.** Site lighting that is highlighting a specific site element should be confined to that site element. Such lighting should be used in the foreground of element to accent the feature such as a sign, a wall, landscape plantings, or other feature.

4.4 RESIDENTIAL DEVELOPMENT FORMS AND PATTERNS

A. Purpose.

1. To promote greater diversity and affordability of housing opportunities to meet the needs of a diverse population with respect to income; disability and accessibility needs; size of household; and stage of life.
2. To provide incentives for the creation of modestly sized market rate housing units and affordable housing units in accordance with the goals of the Winchendon Comprehensive Master Plan and Housing Production Plan, recognizing the Town's moral and practical obligation to contribute to a balanced housing stock for all its residents.
3. To promote better access between housing and public transportation, shops, services, and employment.
4. To encourage less sprawling and more efficient forms of development as an alternative to conventional subdivisions, so as to consume less land, preserve open space, and conform to existing topography and natural features.
5. To encourage the use of sustainable building techniques and universal design.
6. To sustain Winchendon's cultural and historical values and to facilitate contextual development that preserves historically or architecturally significant buildings and landscapes, as well as traditional patterns of land use and neighborhood development.
7. Recognizing that not all of the stated purposes can be achieved in every development and every location, to nonetheless consider each carefully in approving new developments and to be mindful of the need to further these goals across the Town over time.

B. Conventional Residential Development Type (CRD). This form of development is allowed by right with approval of the Planning Board and is designed to comply with Zoning Bylaw in terms of land use, dimensional standards, and intensity standards and the requirements of the Subdivision Regulations.

C. Diversified Residential Development Types (DRD). These forms of development are allowed by special permit from the Planning Board and may provide for a mix of residential building types and selected non-residential uses compatible with and supportive of the residential development. A DRD may also allow organized groups of households to construct residential units and common facilities for their collective and individual ownership and use. It is intended that a DRD be flexible in nature and allow for modification of lot size, size or type of dwellings, density, and required open space in the regulations of

the underlying zoning district, so as to result in patterns of land use that are more compact and more efficiently laid out on a smaller site.

FIGURE 4.4.1 - EXAMPLE OF CONVENTIONAL AND DIVERSIFIED RESIDENTIAL DEVELOPMENT

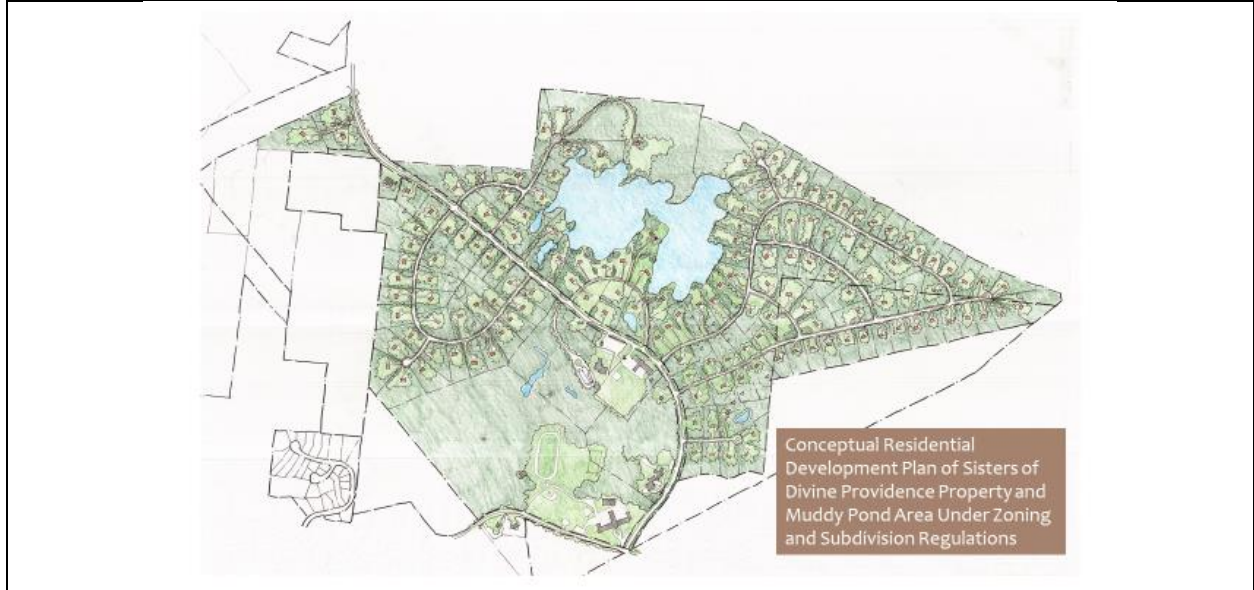

Example of parcel of land subdivided under Conventional Residential Development



Example of parcel of land designed as a Diversified Residential Development with neighborhood scale housing, small village center, and integrated open spaces

The types of DRDs allowed by special permit from the Planning Board are defined below and development standards are provided in **Figure XXX:**

1. Open Space Residential Development (OSRD). A residential development where preservation of natural features such as forested slopes, ravines, ridges, wetlands, and other natural attributes and constraints are prioritized in the location and configuration of residential buildings within a tract of land. OSRDs typically cluster residential units to preserve natural resources as well as to provide open space for active and passive recreational uses. OSRD may also include the preservation and continued operation of existing farms. This form of OSRD (so called “agri-hoods”) may provide a revenue source to preserve the viability of the existing farm while the residential units support the farm operation and provides added value to the residences. OSRDs are allowed by right from the Planning Board when consistent with the density requirement of the underlying zoning district and by special permit is a density bonus is sought by the applicant.

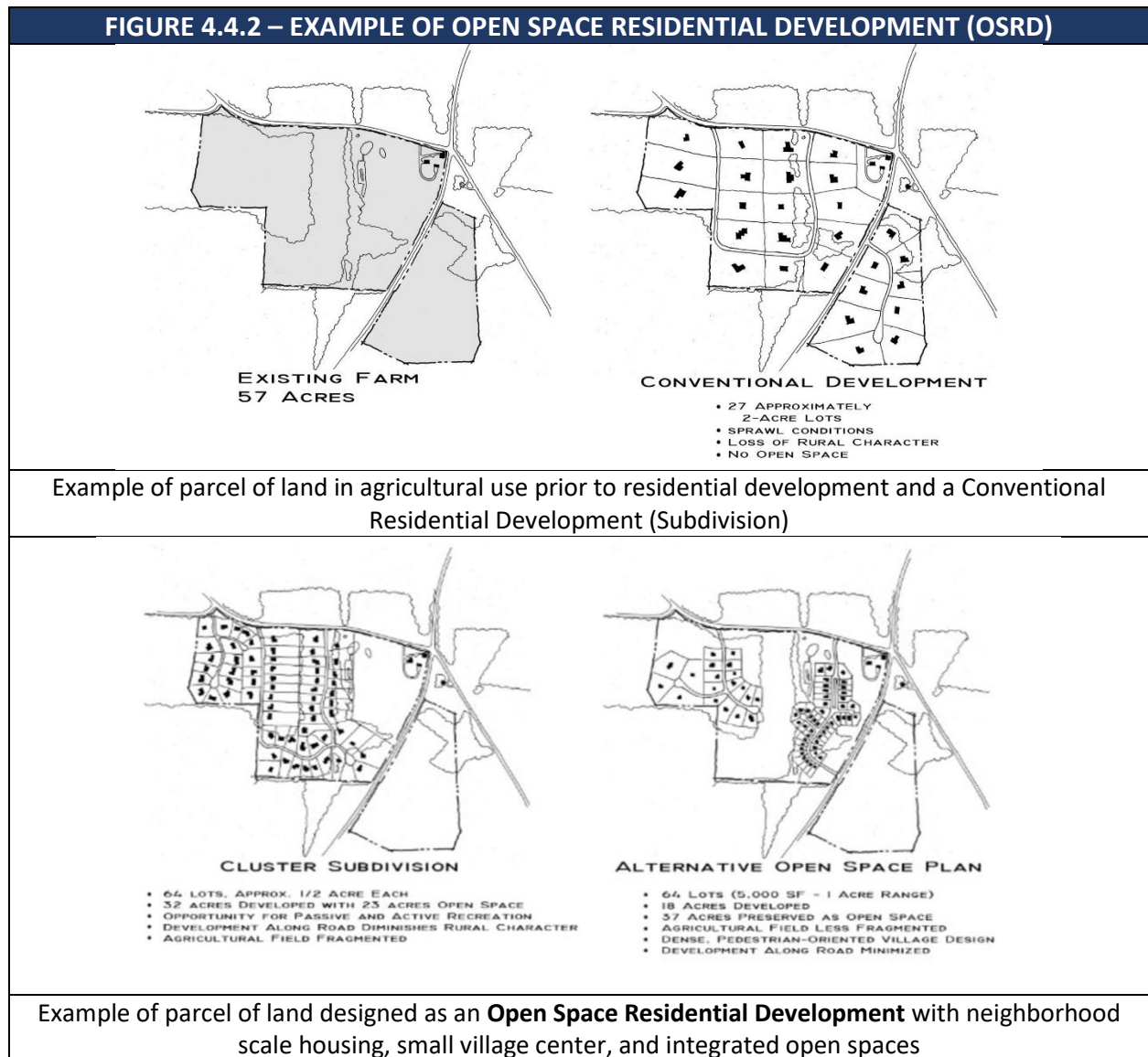

2. Compact Neighborhood Development (CND). There are three (3) types of compact neighborhood developments allowed in Winchendon with design and development standards provided below:

a) Cottage Court Development (CND-CC). A community of small detached or semi-attached residential buildings with narrow frontages arranged around and oriented to a common open space which becomes an important community-enhancing element of the neighborhood. Cottage Courts typically have a network of pedestrian walkways to provide connectivity within the neighborhood while maintaining personal privacy. Cottage Courts may also have shared common facilities such as community garden plots and accessory civic buildings and facilities that support the neighborhood and provide opportunities for residents to gather. Vehicle access is typically located behind the residential units and parking is typically located behind the residential units or in a central location.



- b) ***Traditional Neighborhood Development (CND-TND)***. A type of Compact Neighborhood Development which may include a variety of residential building types with narrow frontages and oriented toward a network of streets, sidewalks, and common open spaces that provide active and passive recreation. TNDs have a network of pedestrian walkways to provide connectivity within the neighborhood and shared community open spaces and facilities. Vehicle access can be front loaded from a public or private street or behind the residential units from an alley.



- c) ***Cohousing Development (CND-CD)***. A type of Compact Neighborhood Development and community of small private homes clustered around shared buildings and common spaces. Each attached or detached residential unit has traditional amenities, including a private kitchen. Shared spaces typically include a common house, which may have a kitchen and dining area, laundry, and assembly spaces for all residents.

Other shared spaces may include community garden plots, recreational fields, parking courts, and shared work spaces.



3. Workforce House Infill Lot (WFH). The purpose of this section to is allow for the construction of an affordable and small detached single family residential unit on a lot with sufficient upland area and public utility services that does not comply with the minimum lot area and/or frontage requirements of the RO, RS, or RT zoning district. The Planning Board may issue a special permit for a Workforce House subject to the following requirements:

a) Eligible Infill Lots.

- 1) Pre-Existing Lot. A pre-existing vacant lot, including a lot held in common ownership with an adjoining lot, existed as of **January 1, 2022**.
- 2) Subdivision of Existing House Lot. A pre-existing house lot divided into two (2) separate house lots where the existing house lot remains in compliance with all dimensional requirements of the underlying zoning district and the

new infill lot meets the requirements of this section.

b) Minimum Dimensional Requirements.

- 1) In the **R80** zoning districts, the infill lot shall have a minimum of 40,000 square feet, a minimum of 40 feet of contiguous frontage on a public street, and 10,000 square feet of upland area.
- 2) In the **R40 and R20** zoning districts, the infill lot shall have a minimum of 20,000 square feet, a minimum of 40 feet of contiguous frontage on a public street, and 5,000 square feet of upland area.
- 3) The minimum front, side, and rear yards shall not be less than the required yards in the underlying zoning district.
- 4) A new workforce single-family home shall be located in a manner that allows its construction to meet the requirements of this section without needing an existing home to be demolished or relocated.

c) Number and Size of Units. An infill workforce house shall be a detached single-family home with **less than 3,000 square feet of gross floor area and no more than three (3) bedrooms.** No infill workforce house approved under this section shall be converted to a two-family or multi-family dwelling. The workforce housing unit may include one (1) accessory dwelling unit.

d) Affordability Requirement. An infill workforce house shall be rented or sold only to an eligible household with an income at or below **80% of the AMI.** The infill workforce house shall be subject to a permanent affordable housing deed restriction. The workforce house shall be eligible for inclusion in the Chapter 40B Subsidized Housing Inventory (SHI) and are subject to the standards in **Section XX of the Winchendon Planning Board Rules & Regulations (Fair Housing and Affordability Standards).**

e) Access. An infill lot shall have frontage on an existing public way or private way that provides safe and adequate access as determined by the Planning Board.

f) Utilities. All infill residential units shall connect to the public sewer and water system.

g) Parking. There shall be at least two (2) off-street parking spaces per infill residential unit. No parking shall be located nearer than ten (10) feet to the adjoining property line, and no parking shall be located in the front yard. Parking areas shall be suitably screened from abutting properties.

h) Further Subdivision. An infill lot approved under this section shall not be further subdivided, reduced in area, or changed in size or shape. It may be used only for one

infill workforce house and one accessory dwelling unit as provided herein.

4. Residential Compound Development (RCD). An existing single family home with no more than three (3) additional residential units may be allowed on a common parcel or tract and subject to the requirements of this Section. The purpose of a Residential Compound Development is to provide an alternative to conventional residential subdivisions by allowing for limited residential development on a parcel of land without requiring the construction of a new road for the purpose of promoting common lot development; reducing impacts of new development on abutting properties; reducing Town maintenance responsibility and costs for a public road; diversify housing options; and preserving the character of the surrounding area. The Planning Board may grant a special permit for a Residential Compound Development in the R80, R40, and R10 districts subject to the following requirements:
 - a) Scale of Development and Permitted Standards. A Residential Compound Development shall consist of a combination of single-family detached dwellings, two-family dwellings, and accessory dwelling units totaling no more than four (4) residential units on a lot or commonly owned lots and accessed by a private access road or driveway.
 - b) Frontage. Frontage may be provided on a single parcel or tract of land held in common ownership, which has the minimum required continuous feet of frontage in the underlying zoning district on a public street or a private road that has been approved and constructed in accordance with the Winchendon Subdivision Regulations.
 - c) Minimum Parcel Size. The parcel or tract of land in common ownership shall contain at least 1.5 times the required minimum lot area in the underlying residential zoning district. Any land which, at the time of submission of an application, is subject to a perpetual restriction, such as the conservation, preservation, agricultural preservation, or watershed preservation restrictions described in Massachusetts General Laws, Chapter 184, Section 31 or any other restriction similar thereto, shall not be included in the minimum lot area.
 - d) Dimensional Requirements. Dimensional requirements on Table 7.2 in the Zoning Bylaw may be modified for best fit the site. All buildings shall be separated by minimum of 25 feet.
 - e) Minimum Perimeter Buffers. The minimum front yard, side yard, and rear yard requirements on Table 7.2 in the zoning district shall apply to the perimeter of the common parcel or tract. The Planning Board may require additional landscaping and screening treatments along the perimeter to ensure a sufficient buffer from adjoining

properties.

- f) Access. Each residential unit in the development shall have adequate and legally enforceable rights of access to a public street via a private access road or driveway with a minimum surface width of twenty-two (22) feet. The Planning Board may reduce the required width of the private access road by two (2) feet with the prior consent of the Town Engineer and Fire Chief.
- g) Open Space. Any land within the common parcel or tract not designated as residential building area shall be designated as common open space. Such land may be used for conservation, outdoor recreation and related facilities, preservation of scenic landscapes or historic structures, and agriculture subject to use restrictions in the underlying zoning district.
- h) Limitation on Further Development. No such common parcel or tract for which a special permit has been issued under this section may be further subdivided and a notation to this effect shall be shown on the site plan and recorded.

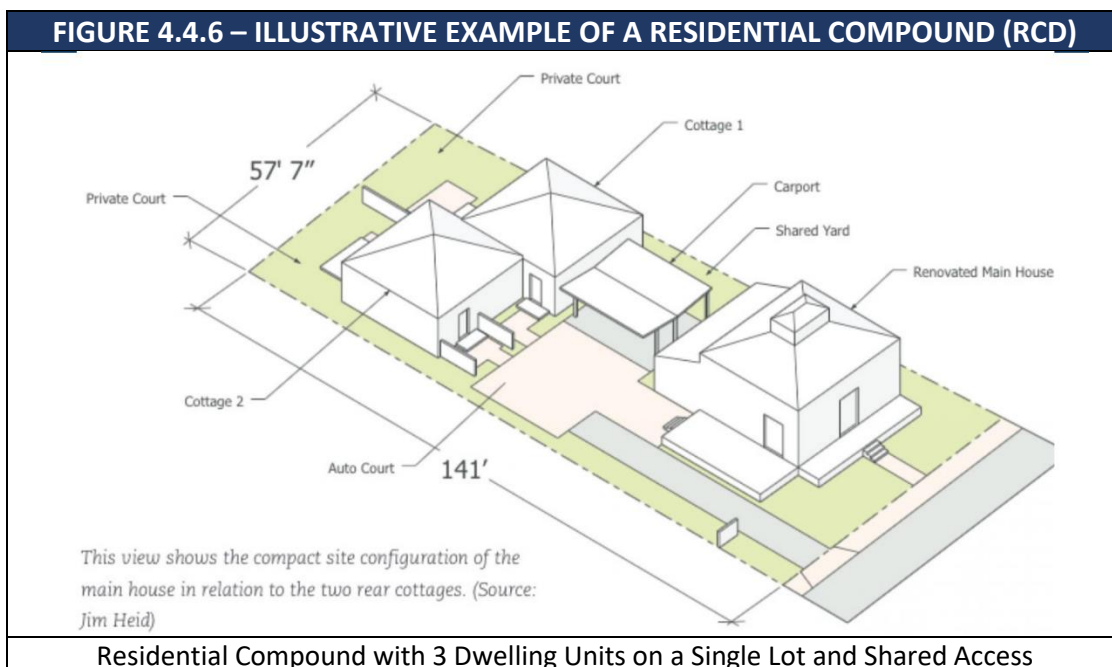

5. Residential Frontage Development (RFD). An RFD is an alternative to an Approval Not Required (ANR) subdivision consisting of a group of single-family detached dwellings or two-family dwellings combined for a total of no more than ten (10) residential units and sharing a common frontage road which shall meet the requirements for a minor street in Section XX of the Subdivision Regulations. The purpose of an RFD is to reduce impacts of new development on a public street vegetative buffer and abutting properties; reduce

curb cuts onto a public streets; expand housing choices and affordability; creates useful open space; and preserve the semi-rural character of the Town. The Planning Board may grant a special permit for a Residential Frontage Development in any residential district subject to the requirements below.

- a) General Standards. A Residential Frontage Development shall consist of a group of single-family detached dwellings and/or two-family dwellings. For every five (5) ANR building lots permitted under the requirements of **Section ANR** of the Subdivision Regulations, an additional building lot shall be permitted for a combined total of no more than ten (10) residential units sharing a common private access road.
- b) Residential Units and Dimensional Standards. Building lots may contain one (1) single-family detached dwellings with one (1) Accessory Dwelling Unit, or a Duplex but the total number of residential units in the development shall not exceed ten (10). Under this bylaw, the dimensional requirements regarding lot size, frontage, and setbacks for a two-family dwelling are the same as for a single-family detached residential unit in the underlying residential zoning district.
- c) Affordable Units. Residential Frontage Developments are required to create one (1) affordable residential unit for each eight (8) residential units in the development. All affordable dwelling units are subject to the requirements of **Section XXX (Affordable Housing Requirements)**.
- d) Access. Each residential lot shall have legally enforceable rights of access to a public street via a private frontage access road which meets the requirements for **Section XX of the Subdivision Regulations** except that the maximum surface width of the private access road shall be 20 feet. The Planning Board may allow a waiver of the width of a private access roads to no less than 18 feet or more than 24 feet with prior approval of the Town Engineer and Fire Chief. Each building lot shall have physical access over said private access road.
- e) Open Space. All land between the public street and the private frontage access road shall be designated as permanent common open space. Such land may be used only for conservation, outdoor recreational facilities of a noncommercial nature, agriculture, preservation of scenic or historic structures, and structures accessory to any of the above uses (including swimming pools, tennis courts, stables, greenhouses).
- f) Streetscape. If natural vegetation along the public street frontage is removed to allow for recreational uses on the common open space, deciduous trees shall be installed on a parallel line setback 10 feet from the public street right-of-way at 40 feet on center. At installation, the trees shall be 4 inches DBA. If a public sidewalk or private

pathway exists along the public street adjacent to the building lots, then the applicant shall install a similar facility along the entire frontage of the development consistent in width and materials as the adjacent sidewalk or pathway.

- g) *Proof Plan and Alternative Plan*. An application for a special permit from the Planning Board pursuant to a Residential Frontage Development shall submit an ANR subdivision proof plan meeting the requirements of **Section XX of the Subdivision Regulations** demonstrating and illustrating the number of building lots that can be created by right. The applicant shall also submit an alternate frontage development plan setting forth:

- 1) The layout of all building lots, the type of dwelling units, the private frontage access road, and common open spaces.
- 2) The details of all entrances and exits to and from the public street.
- 3) All proposed deed restrictions.
- 4) The proposed locations of all existing and proposed commonly owned structures;
- 5) The location and details of all existing and proposed utilities and proposed connections.
- 6) The existing and proposed easements or rights of way traversing or adjacent to the tract.
- 7) The boundaries, if any, of any area which the Conservation Commission has determined to be subject to Massachusetts General Laws, Chapter 131, Section 40.

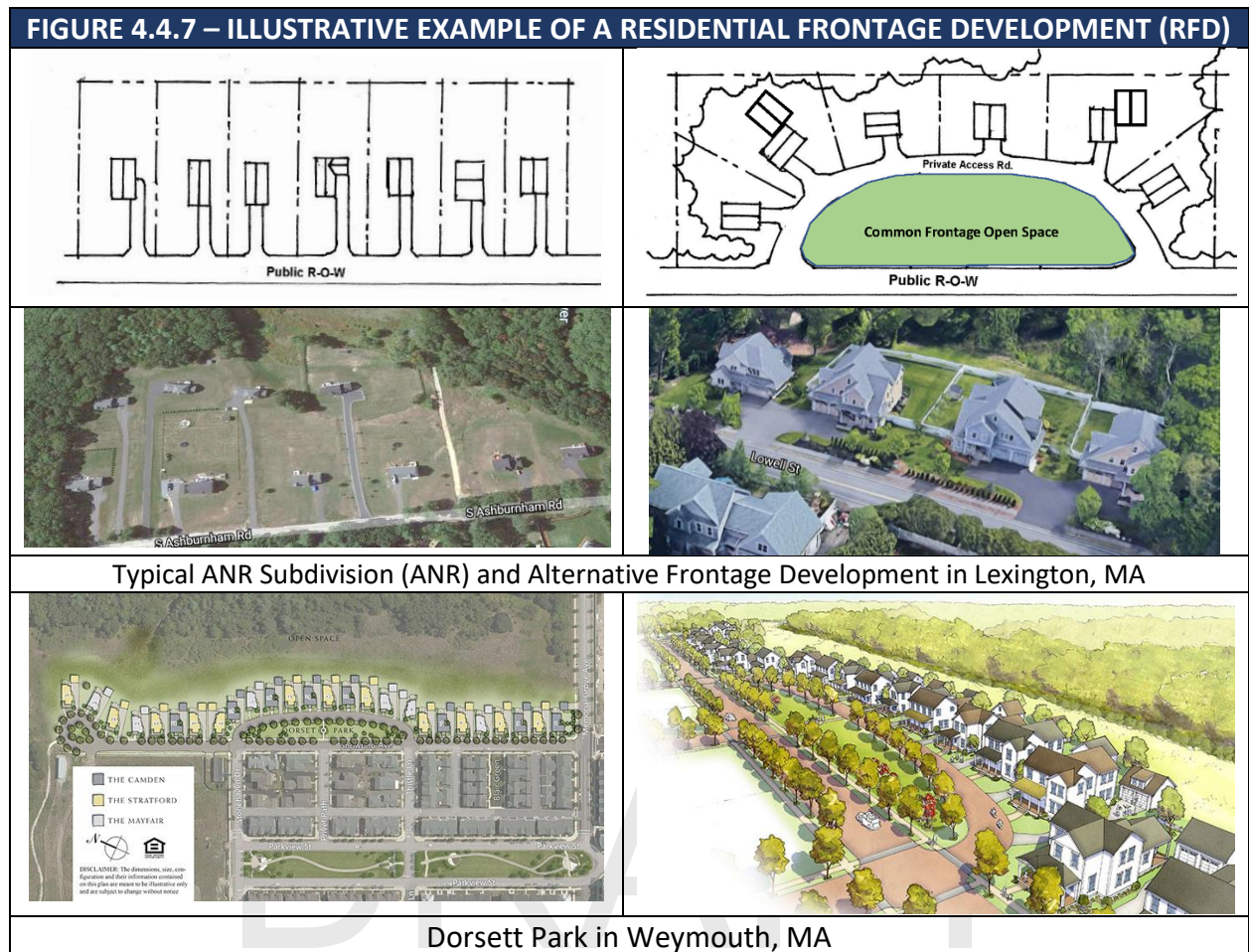

6. Adaptive Reuse Residential Development (ARRD). A special-condition housing development in which non-residential buildings are repurposed and rehabilitated for residential use such as agricultural buildings, publicly-owned buildings, religious and civic buildings, and commercial/industrial buildings. This type of diversified residential development is subject the following requirements:

- a) General Requirements. The Planning Board may authorize an existing non-residential structure, that was constructed at least 10 years prior to the date of application for approval of the special permit, to be converted to a residential use not otherwise permitted.
- b) Site Development Plan. The special permit shall incorporate by reference the building design and definitive site development plans filed with the application, and, where applicable, any legally binding documents that ensure the completion and continued availability of any proposed improvement or compliance with special permit conditions.
- c) Special Permit Findings. In order to grant a special permit, the Planning Board shall

determine that:

- 1) The structure can be modified for a residential use that does not have adverse impacts on the adjacent neighborhood;
- 2) The exterior character of the structure is maintained and is compatible with the adjacent neighborhood; and
- 3) Modification of the existing structure maintains more of the site as open space than the alternative of removal of the structure and further subdivision of the lot into individual house lots.

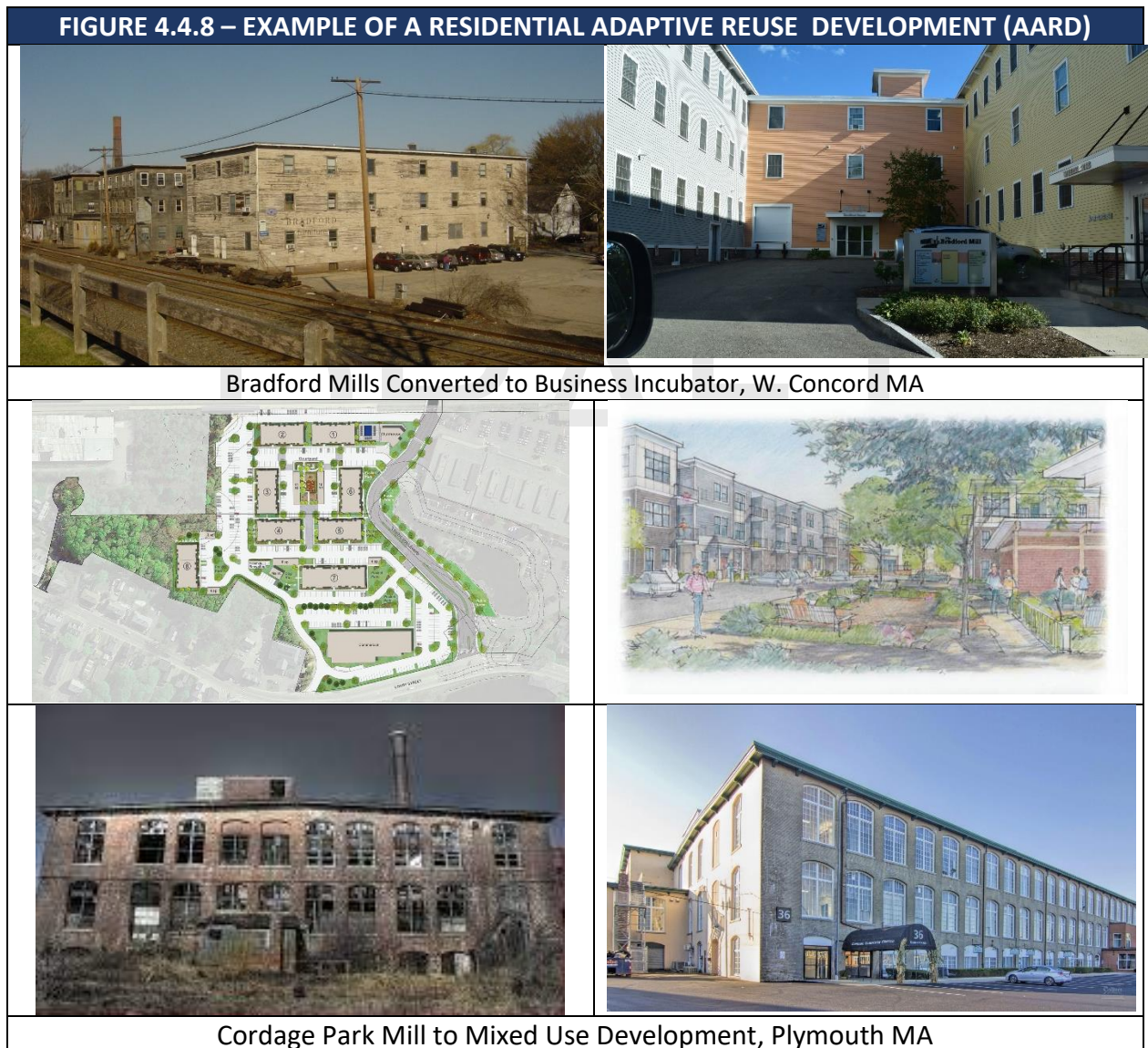

B. Compact Neighborhood Development Design Standards. CNDs should be consistent with the following development standards:

FIGURE 4.4.9 - OPEN SPACE RES. DEVELOPMENT & COMPACT NEIGHBORHOOD DEVELOPMENT STANDARDS					
		Open Space Community Development (OSCD)	Cottage Court (CND-CC)	Traditional Neighborhood Development (CND-TND)	Cohousing Development (CND-CD)
1.1. DEVELOPMENT STANDARDS					
A.	Tract Size (Min.)	80,000 S.F.	10,000 S.F.	40,000 S.F.	20,000 S.F.
B.	Tract - Public Street Frontage (Min.)	80 Ft.	40 Ft.	50 Ft.	50 Ft.
C.	Tract Perimeter - Front Setback (Min.)	50 Ft.	20 Ft.	20 Ft.	20 Ft.
D.	Tract Perimeter - Side Setback (Min.)	20 Ft.	15 Ft.	15 Ft.	15 Ft.
E.	Tract Perimeter - Rear Setback (Min.)	20 Ft.	15 Ft.	15 Ft.	15 Ft.
H.	Tract Impervious Surface (Max.)	25%	30%	30%`	30%
F.	Total Common Open Space (Min.)	33% of Tract	20% of Tract	20% of Tract	20% of Tract
G.	Total Outdoor Amenity Space (Min.)	15% of Tract	15% of Tract	15% of Tract	15% of Tract
1.2. PERMITTED BUILDING TYPES					
SEE SECTION 4.6					
1.3. PERMITTED OUTDOOR AMENITY SPACES					
SEE SECTION 6.0					
1.4. ADDITIONAL STANDARDS					
A.	Access Road (Subdivision Regs, S. 7.2)	Minor Complete Street, 50 Ft ROW	Minor Complete Street, 50 Ft ROW	Minor Complete Street, 50 Ft ROW	Minor Complete Street, 50 Ft ROW
B.					
C.					

C. Permitted Building Types in Diversified Residential Developments. The allowed types of residential buildings permitted in different DRDs are identified in Figure 4.4.10 below:

TABLE 4.4.10 - ALLOWED BUILDING TYPES IN DIVERSIFIED RESIDENTIAL DEVELOPMENTS

RESIDENTIAL DEVELOPMENT TYPES	BUILDING TYPES					
	Standard S.F. House	Cottage	Townhouse	Duplex (2 RUs)	Multiplex (3-16 RUs)	Mixed Use Building (MUB)
1. Open Space Residential Development (OSrD)	X	X	X	X	X	
2. Compact Neighborhood Development (CND)						
A. Cottage Court Development (CCD)	X	X	X	X		
B. Traditional Neighborhood Development (TND)	X	X	X	X	X	X
C. Cohousing Development (COD)	X	X	X	X	X	
3. Residential Frontage Development (RFD)	X	X		X		
4. Workforce Housing Infill Lot (WHI)				X		
5. Residential Compound Development (RCD)	X	X	X	X		
6. Adaptive Reuse Residential Development (ARRD)	X	X	X	X	X	X
7. Mixed Use Development/Town Center (MUD-TC)			X		X	X

4.5 ARCHITECTURAL GUIDELINES

The following guidelines outline the general residential building types and architectural design elements that should be viewed as a baseline for well-designed residential architecture in the Town of Winchendon.

- A. Building Massing.** The building massing should be designed to reduce the overall perceived scale and provide simple and evocative forms that reinforce the traditional New England setting and a human-scaled environment of Winchendon.
 1. Strengthen Prominence of Building Entry. Building massing should reinforce the purpose and readability of the building. For example, building massing should emphasize and highlight the location of the primary building entrance.
 2. Visually Reduce Larger Building Scale. Large building masses should be broken down through variations in the roof lines, bays, setbacks, upper-level stepbacks, and other types of architectural articulation. Larger buildings should look like smaller component parts put together.
 3. Simplify Smaller Buildings. Smaller building masses should remain simple and not overly complicated.
 4. Reinforce Consistency with Residential Context. Building massing and scale should be developed to be consistent with the surrounding residential context. Building scale must respect the scale of the residential prototype on which it is based. For example, a connected farmhouse prototype loses its effectiveness and meaning if it becomes too exaggerated or overinflated.

5. Design Variation in Type and Scale. An eclectic variation is a signature of New England communities. Residential development with multiple buildings should vary the building scale and building type. Building types should include enough variability in building massing and scale that repetition is not immediately apparent.

B. Façade Composition and Components. Composition of building facades should include architectural features and building components that reduce the scale of large building masses, reinforce the building character to reflect traditional New England styles, and provide detail and articulation of the overall building.

1. Emphasize Façade Rhythm and Patterns. Building façades should be broken into vertical and horizontal parts that reinforce a rhythm and pattern in the architecture. Building facades, the pattern of windows and doors, and the roof forms should be integrated as a cohesive design. Variation in the façade is encouraged through decorative components, or functional elements such as porches or entryways.
2. Highlight Architectural Detail. Additional architectural detail should be used to reinforce the smaller scale residential character through the use of roof brackets, porches, covered entries, window and door surrounds, or pediment or parapet detail.
3. Conceal Garage Doors. Garage doors should be designed to integrate within the building façade and relate to the aesthetic of carriage doors or barn doors more frequently associated with New England character.
4. Integrate Utilitarian Components into the Façade Design. All functional, utilitarian, or mechanical components of the building facade should be integrated into the façade or screened so as to be part of the composition of the overall building design. Mechanical vents, service elements, and similar components of buildings should be hidden to match other materials and colors of the façade.

C. Historic Structures. When such structures exist and are to be retained, a residential development should integrate and leverage the value of a historic structure within the design and layout of the development plan. Reuse of existing historic structures should follow the U.S. Secretary of the Interior’s Standards for Rehabilitation as appropriate.

1. Integrate Historic Structures. Existing historic structures should be integrated into any new development plan. New buildings and additions should complement and reflect the structure and style of any existing older structures. Historic structures should be considered for adaptive reuse, preservation, sensitive rehabilitation, or restoration as may be appropriate to the historic structure and nature of its reuse.
2. Emphasize Compatible Development. The reuse of the existing historic structure should be compatible with the ability of the structure to accommodate residential uses. New

construction or additions should also be compatible with and complementary to the architectural style of the historic structure.

3. Pursue Thoughtful Renovation. When a historic structure is being renovated to residential use, that renovation should retain the integrity of the historic structure and be sensitive to its underlying design characteristics or historic significance.
4. Create Authenticity to Current Time. New construction or additions should be authentic to the current time in which they are built.

D. Building Roof Forms. Roof form has a significant impact on the character and style of the architecture. Residential roof forms should be both authentic to the type of building they are part of and strive to reinforce a sense of New England neighborhood character and scale.

1. Reinforce New England Village Character. Traditional steeply-pitched roof forms are encouraged in order to reinforce a New England sense of community and assist in managing snow loads. Roof slopes should be in the range of 8:12 to 12:12 (vertical: horizontal). Traditional and most appropriate roof styles in residential developments in New England include gable, hip, mansard, gambrel, saltbox, and shed.
2. Develop Roof Variation. Variation in roof pitch and heights contribute to residential character. Variation in roof types could be used across a different buildings in a residential development but should not be used in combination on a single building.
3. Reinforce a Human-scale to Buildings. Large uninterrupted roof forms should be avoided and articulated with roof gables, dormers, brick or stone chimneys or other roof forms that provide variety and interest to the overall building form.
4. Integrate and Screen Utilities. Mechanical equipment on rooftops should be screened from visibility of pedestrians standing at grade on surrounding walkways by means of walls, decorative grilles, or roof parapets. Screening features should be a part of the building composition and design. Selected materials should complement the overall roof and façade design. Other utilities, such as solar panels should be integrated into the design of the roof.

E. Building Lighting. Building lighting should be used to highlight and emphasize functional and decorative aspects of the building massing and facades. Building lighting should be energy efficient and designed to be minimized and focused on key components of the building. Lighting design must comply with the lighting requirements in Section (XX - Performance Parameters) of the Zoning Bylaw.

1. Define Hierarchy of Lighting. Building entries should be a primary focus of building lighting to reinforce safety, security, and convenience for access to the building. Lighting

to highlight building features, key architectural elements, accents, or signage should be a secondary focus of building lighting.

2. Minimize Quantity of Lighting. Illumination levels should be provided at the minimum level that is required to provide the function desired.
3. Coordinate Light Fixture Design. Lighting fixtures should be selected to contribute to the overall character of the building and development site, and consistent with the overall design and sense of place.



4.6. RESIDENTIAL AND MIXED USE BUILDING TYPES

The following guidelines outline the general residential building types and design elements that should be viewed as a baseline for well-designed and traditional residential forms, patterns, and architecture in a human-scaled environment in the Town of Winchendon. The table also includes design guidelines for accessory dwelling units and community buildings that are often included in diversified residential developments such as open space developments, cottage courts, traditional neighborhood developments, housing cooperatives, and other forms of compact neighborhoods.

FIGURE 4.6.1 - STANDARD SINGLE FAMILY HOUSE DESIGN GUIDELINES	
Definition	Diagram
<p>A moderate floor plate, detached, principal residential building type with one (1) residential unit and ground floor entry typically from a front door.</p>	
Character Examples (For illustrative purpose only)	
	
Typical Specifications*	
Lot Dimensions	
Lot Area	
Rear or No Driveway Access	4,000 - 10,000 SF
Front Driveway Access	5,000 - 15,000 SF
Lot Width	
Rear or No Driveway Access	40 - 70 Ft
Front Driveway Access	55 - 75 Ft
Lot Depth	80 - 150 Ft
Lot Development	
Lot/Area Coverage by Impervious Surface (Max.)	60%
Lot/Area Outdoor Amenity Space (Min.)	20%
Building Placement	
Primary Street Front Setback	10 - 20 Ft.
Secondary Street Front Setback	10 - 20 Ft.
Side Setback	10 Ft.
Rear Setback/Garage from Rear Alley/Access St.	3 Ft.
Rear Setback/Primary Building	30 - 60 Ft.
Building Separation (Min.)	15 Ft.

Building Size and Massing	
Residential Units Per Building Type (Max.)	1 Res. Unit; 2 Accessory Units
Building Footprint	3,000 S.F.
Typical Res. Unit Gross Floor Area (GFA)	< 6,000 S.F. Per Unit
Typical Res. Unit Living Area (L.A.)	2,000 – 3,500 SF
Front Façade Width	22 – 32 Ft.
Front Façade Build Out (% of Building to Lot Width)	50%
Front Façade Off-Set	Not Applicable
Building Depth	28 – 48 Ft.
Ground Floor Elevation (Above Ground Plain)	2 - 4 Ft.
Ground Floor Story Height	9 - 12 Ft.
Upper Story Height (Min./Max.)	9 - 12 Ft.
Building Height/Number of Stories	35 Ft./2.5 Stories
Street Facing Entrance	Preferred
Roof Type	Gable, Hip, Gambrel
Building Outdoor Amenity Space	1/Res. Unit and ADUs
Façade Composition (Street or front facing building elevation)	
Fenestration Ground Floor (Min.)	15 - 50%
Fenestration Upper Floor (Min.)	15 - 50%
Blank Wall (% of front façade without fenestration)	Not Applicable
Parking	
Primary Street Front Setback (Min.)	Behind Front Façade
Side and Rear Setback (Min.)	5 Ft.
Parking Ratio	1 - 2 Spaces Per Residential Unit
Typical Residential Density	
Gross Density	4 - 8 Res. Units/Acre
Additional Design and Development Guidelines	
None	

* Not all residential buildings will be located on a separate lot such as in condominium developments. Where separate lots do not exist, the side and rear setbacks should be doubled to determine appropriate space between primary buildings.

FIGURE 4.6.2 - COTTAGE COURT AND WORKFORCE COTTAGE DESIGN GUIDELINES

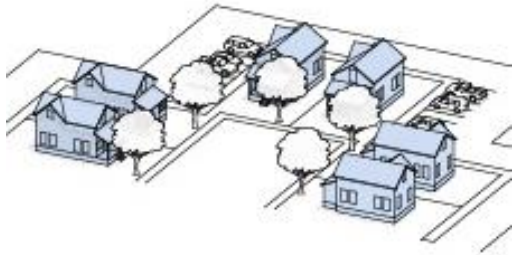
Definition	Diagram
<p>The smallest principal residential building type with one (1) dwelling unit. The cottage typically has a small floor plate, narrow massing, detached or semi-detached, and 1 to 1 1/2 stories. Cottages may be permitted on individual lots or as part of a Cottage Court which is a group of detached or semi-detached cottages arranged and oriented around a shared open space. The common courtyard is an important community-enhancing element that often replaces the backyard and provides direct entrances from the homes. The workforce cottage is a small single family home on a small lot and affordable under Section XXX of the Zoning Bylaw.</p>	

Character Examples (For illustrative purpose only)

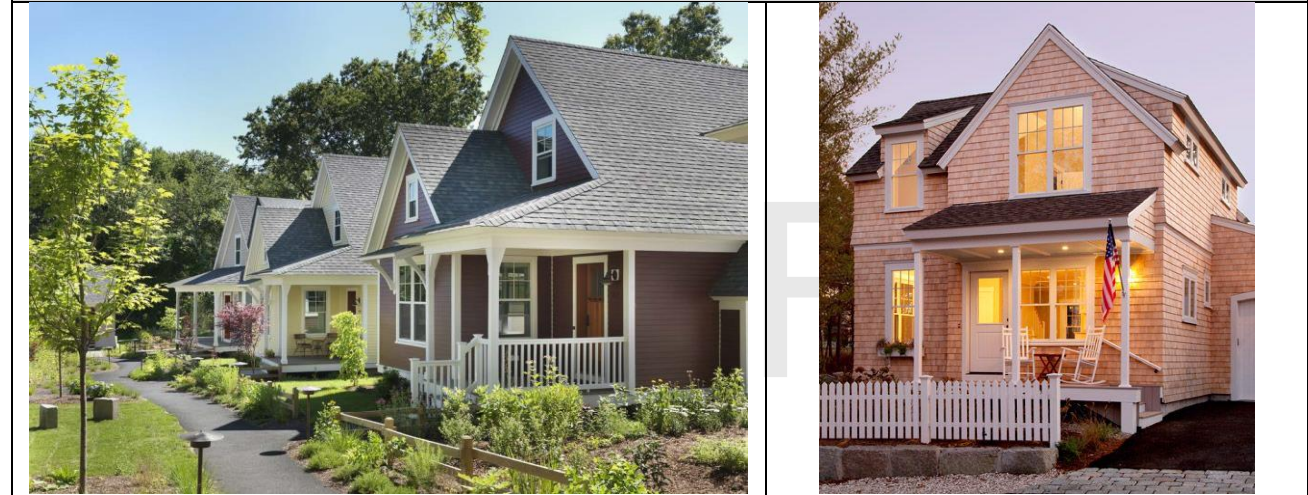

Typical Lot and Building Specifications*

Cottage Court Tract Size**	
Width	115 - 160 Ft.
Depth	100 - 150 Ft.
Area	11,500 - 24,000 S.F.
Number of Cottages Per Common Court	5 - 16 Res. Units
Lot Dimensions	
Lot Area	
Rear or No Driveway Access	4,000 - 10,000 SF
Front Driveway Access	5,000 - 15,000 SF
Lot Width	
Rear or No Driveway Access	32 - 48 Ft
Front Driveway Access	34 - 48 Ft
Lot Depth	70 - 100 Ft.
Lot Development	
Lot/Area Coverage by Impervious Surface (Max.)	60%

Lot/Area Outdoor Amenity Space (Min.)	20%
Building Placement	
Primary Street Front Setback	10 - 20 Ft.
Secondary Street Front Setback	10 - 20 Ft.
Side Setback	5 - 10 Ft.
Rear Setback/Garage from Rear Alley/Access St.	3 Ft.
Rear Setback/Primary Building	20 - 30 Ft.
Building Separation (Min.)	10 Ft.
Building Size and Massing	
Residential Units Per Building Type (Max.)	1 Res. Unit
Building Footprint	1,800 S.F.
Typical Res. Unit Gross Floor Area (GFA)	< 3,000 S.F. Per Unit
Typical Res. Unit Living Area (L.A.)	500 – 1,800 SF
Front Façade Width	18 – 24 Ft.
Front Façade Build Out (% of Building to Lot Width)	60%
Front Façade Off-Set	Not Applicable
Building Depth	24 – 36 Ft.
Ground Floor Elevation (Above Ground Plain)	2 - 3 Ft.
Ground Floor Story Height	8 - 10 Ft.
Upper Story Height (Min./Max.)	8 - 10 Ft.
Building Height/Number of Stories	24 Ft./1.5 Stories
Street Facing Entrance	Preferred
Roof Type	Gable, Hip, Gambrel
Building Outdoor Amenity Space	1/Res. Unit
Façade Composition (Street or front facing building elevation)	
Fenestration Ground Floor (Min.)	15 - 50%
Fenestration Upper Floor (Min.)	15 - 50%
Blank Wall (% of front façade without fenestration)	Not Applicable
Parking	
Primary Street Front Setback (Min.)	Behind Front Façade
Side and Rear Setback (Min.)	5 Ft.
Parking Ratio	1 - 2 Spaces Per Residential Unit
Typical Residential Density	
Gross Density	10 - 20 Res. Units Per Acre
Additional Design and Development Guidelines	
None	

* Not all residential buildings will be located on a separate lot such as in condominium developments. Where separate lots do not exist, the side and rear setbacks should be doubled to determine appropriate space between primary buildings.

** A Cottage Court Development may contain more than one Courts with 5 to 16 Cottages



FIGURE 4.6.3 - DUPLEX DESIGN GUIDELINES

Definition	Diagram
<p>A detached residential building that consists of two (2) residential units each with an entry from the street. This building type has the appearance of a small-to-medium single family house and may include a rear yard and rear access from an alley.</p>	
Character Examples (For illustrative purpose only)	
	
Typical Specifications*	
Lot Dimensions	
Lot Area	
Rear or No Driveway Access	4,000 - 10,000 S.F.
Front Driveway Access	5,000 - 15,500 S.F.
Lot Width	
Rear or No Driveway Access	40 - 70 Ft
Front Driveway Access	55 - 75 Ft
Lot Depth	100 - 150 Ft
Lot Development	
Lot/Area Coverage by Impervious Surface (Max.)	60%
Lot/Area Outdoor Amenity Space (Min.)	20%
Building Placement	
Primary Street Front Setback	10 - 20 Ft.
Secondary Street Front Setback	10 - 20 Ft.
Side Setback	10 Ft.
Rear Setback/Garage from Rear Alley/Access St.	3 Ft.
Rear Setback/Primary Building	30 - 60 Ft.
Building Separation (Min.)	20 Ft.
Building Size and Massing	
Residential Units Per Building Type (Max.)	2 Res. Units

Building Footprint	1,500 S.F. Per Res. Unit
Typical Res. Unit Gross Floor Area (GFA)	< 3,000 S.F. Per Unit
Typical Res. Unit Living Area (L.A.)	600 – 2,400 SF
Front Façade Width	28 – 55 Ft.
Front Façade Build Out (% of Building to Lot Width)	50%
Front Façade Off-Set	Not Applicable
Building Depth	28 – 60 Ft.
Ground Floor Elevation (Above Ground Plain)	2 - 4 Ft.
Ground Floor Story Height	9 - 12 Ft.
Upper Story Height (Min./Max.)	9 - 12 Ft.
Building Height/Number of Stories	35 Ft./2.5 Stories
Street Facing Entrance	Preferred
Roof Type	Gable, Hip, Gambrel
Building Outdoor Amenity Space	1/Res. Unit
Façade Composition (Street or front facing building elevation)	
Fenestration Ground Floor (Min.)	15 - 50%
Fenestration Upper Floor (Min.)	15 - 50%
Blank Wall (% of front façade without fenestration)	Not Applicable
Parking	
Primary Street Front Setback (Min.)	Behind Front Façade
Side and Rear Setback (Min.)	5 Ft.
Parking Ratio	1 - 2 Spaces Per Residential Unit
Typical Residential Density	
Gross Density	6 - 12 Res. Units/Acre
Additional Design and Development Guidelines	
The two (2) residential units within a duplex building type may be side-by-side and both oriented toward the front lot line. On corner lots, one residential unit may be oriented toward each front lot line resulting in units that are back-to-side in orientation. Dwelling units that are stacked one over the other or attached front to back in orientation are also permitted.	

* Not all residential buildings will be located on a separate lot such as in condominium developments. Where separate lots do not exist, the side and rear setbacks should be doubled to determine appropriate space between primary buildings.

FIGURE 4.6.4 - TRIPLEX BUILDING DESIGN GUIDELINES

Definition	Diagram
<p>A small-to-medium sized detached structure that consists of three (3) residential units that are stacked on top of each other on consecutive floors, attached side by side, or a combination of both. There is typically one entry for each ground floor unit and a shared entry for the units above. Side-by-side Triplexes may be designed to resemble large farmhouses with attached carriage houses. A triplex may be located on one (1) or more lots and each of the dwelling unit is intended to be occupied by one (1) family.</p>	
Character Examples (For illustrative purpose only)	
	
Typical Specifications*	
Lot Dimensions	
Lot Area	
Rear or No Driveway Access	5,000 - 11,000 S.F.
Front Driveway Access	6,500 - 15,500 S.F.
Lot Width	
Rear or No Driveway Access	40 - 55 Ft.
Front Driveway Access	40 - 65 Ft.
Lot Depth	85 - 150 Ft.
Lot Development	
Lot/Area Coverage by Impervious Surface (Max.)	65%
Lot/Area Outdoor Amenity Space (Min.)	20%
Building Placement	
Primary Street Front Setback	10 - 25 Ft.
Secondary Street Front Setback	10 - 25 Ft.
Side Setback	8 - 12 Ft.
Rear Setback/Garage from Rear Alley/Access St.	3 Ft.
Rear Setback/Primary Building	30 - 60 Ft.
Building Separation (Min.)	15 - 25 Ft.
Building Size and Massing	
Residential Units Per Building Type (Max.)	3 Res. Units
Building Footprint (Max.)	1,800 S.F. Per Res. Unit
Typical Res. Unit Gross Floor Area (GFA)	< 2,000 S.F. Per Res. Unit

Typical Res. Unit Living Area (L.A.)	700 - 1,600 S.F.
Front Façade Width	36 – 55 Ft.
Front Façade Build Out (% of Building to Lot Width)	70%
Front Façade Off-Set	Not Applicable
Building Depth	35 – 64 Ft.
Ground Floor Elevation (Above Ground Plain)	2 - 4 Ft.
Ground Floor Story Height	9 - 12 Ft.
Upper Story Height (Min./Max.)	9 - 12 Ft.
Building Height/Number of Stories	35 Ft./2.5 Stories
Street Facing Entrance	Preferred
Roof Type	Gable, Hip, Gambrel
Building Outdoor Amenity Space	1/Res. Unit
Façade Composition (Street or front facing building elevation)	
Fenestration Ground Floor (Min.)	15 - 50%
Fenestration Upper Floor (Min.)	15 - 50%
Blank Wall (% of front façade without fenestration)	Not Applicable
Parking	
Primary Street Front Setback (Min.)	Behind Front Façade
Side and Rear Setback (Min.)	5 Ft.
Parking Ratio	1 - 2 Spaces Per Residential Unit
Typical Residential Density	
Gross Density	8 - 20 Res. Units/Acre
Additional Design and Development Guidelines	
None	

* Not all residential buildings will be located on a separate lot such as in condominium developments. Where separate lots do not exist, the side and rear setbacks should be doubled to determine appropriate space between primary buildings.

FIGURE 4.6.5 - MULTIPLEX BUILDING DESIGN GUIDELINES

Definition	Diagram
<p>A moderate floor plate, detached, multi-story principal residential building type with four (4) to sixteen (16) residential units primarily accessed from a single principal entrance and interior hallway or stairway. A multiplex may include apartments, condominiums, or cooperative residential units, and shared spaces within the building for utilities and amenities.</p>	
Character Examples (For illustrative purpose only)	
	
Typical Specifications*	
Lot Dimensions	
Lot Area	
Rear or No Driveway Access	7,500 - 15,500 S.F.
Front Driveway Access	9,600 - 18,000 S.F.
Lot Width	
Rear or No Driveway Access	100 - 150 Ft.
Front Driveway Access	96 - 120 Ft.
Lot Depth	
Lot Depth	100 - 150 Ft.
Lot Development	
Lot/Area Coverage by Impervious Surface (Max.)	65%
Lot/Area Outdoor Amenity Space (Min.)	20%
Building Placement	
Primary Street Front Setback	10 - 25 Ft.
Secondary Street Front Setback	10 - 25 Ft.
Side Setback	8 - 12 Ft.
Rear Setback/Garage from Rear Alley/Access St.	3 Ft.
Rear Setback/Primary Building	30 - 60 Ft.
Building Separation (Min.)	15 - 25 Ft.
Building Size and Massing	
Residential Units Per Building Type (Max.)	4 - 16 Res. Units
Building Footprint (Max.)	1,000 S.F. Per Res. Unit

Typical Res. Unit Gross Floor Area (GFA)	< 2,000 S.F. Per Res. Unit
Typical Res. Unit Living Area (L.A.)	400 - 1,200 S.F.
Front Façade Width	50 – 100 Ft.
Front Façade Build Out (% of Building to Lot Width)	70%
Front Façade Off-Set (Articulation Per Linear Foot)	4 Feet Per Each 50 Linear Feet
Building Depth	35 – 75 Ft.
Ground Floor Elevation (Above Ground Plain)	2 - 4 Ft.
Ground Floor Story Height	9 - 12 Ft.
Upper Story Height (Min./Max.)	9 - 12 Ft.
Building Height/Number of Stories	40 Ft./2.5 Stories
Street Facing Entrance	Preferred
Roof Type	Gable, Hip, Gambrel, Flat
Building Outdoor Amenity Space	1/Res. Unit
Façade Composition (Street or front facing building elevation)	
Fenestration Ground Floor (Min.)	15 - 50%
Fenestration Upper Floor (Min.)	15 - 50%
Blank Wall (% of front façade without fenestration)	Not Applicable
Parking	
Primary Street Front Setback (Min.)	Behind Front Façade
Side and Rear Setback (Min.)	5 Ft.
Parking Ratio	1 - 2 Spaces Per Residential Unit
Typical Residential Density	
Gross Density	12 - 20 Res. Units/Acre
Additional Design and Development Guidelines	
None	

* Not all residential buildings will be located on a separate lot such as in condominium developments. Where separate lots do not exist, the side and rear setbacks should be doubled to determine appropriate space between primary buildings.



FIGURE 4.6.6 – TOWNHOUSE/ROWHOUSE DESIGN GUIDELINES

Definition	Diagram
<p>A small-to medium-sized attached structure that consists of 3 or more multi-story single family residential units placed side-by-side and attached by a common wall. Entries are typically on the narrow side of the unit and facing a street or courtyard. Vehicle access and parking garages are located to the side or rear of the residential units.</p>	
Character Examples (For illustrative purpose only)	
	
Typical Specifications*	
Lot Dimensions	
Lot Area	
Rear or No Driveway Access	1,600 - 5,000 S.F.
Front Driveway Access	1,600 - 5,000 S.F.
Lot Width	
Rear or No Driveway Access	25 - 32 Ft.
Front Driveway Access	18 - 25 Ft.
Lot Depth	85 - 120 Ft.
Lot Development	
Lot/Area Coverage by Impervious Surface (Max.)	65%
Lot/Area Outdoor Amenity Space (Min.)	20%
Building Placement	
Primary Street Front Setback	10 - 25 Ft.
Secondary Street Front Setback	10 - 25 Ft.
Side Setback (Where no common wall exists)	8 - 12 Ft.
Rear Setback/Garage from Rear Alley/Access St.	3 Ft.
Rear Setback/Primary Building	20 - 60 Ft.
Building Separation (Min.)	20 Ft.
Building Size and Massing	
Residential Units Per Building Type (Max.)	3 - 8 Res. Units Per Group

Building Footprint (Max.)	1,400 S.F. Per Res.Unit
Typical Res. Unit Gross Floor Area (GFA)	<3,000 S.F. Per Res. Unit
Typical Res. Unit Living Area (L.A.)	1,000 - 2,700 S.F.
Front Façade Width	18 – 30 Ft.
Front Façade Build Out (% of Building to Lot Width)	70%
Front Façade Off-Set (Articulation Per Linear Foot)	Not Applicable
Building Depth	34 – 60 Ft.
Ground Floor Elevation (Above Ground Plain)	2 - 4 Ft.
Ground Floor Story Height	9 - 12 Ft.
Upper Story Height (Min./Max.)	9 - 12 Ft.
Building Height/Number of Stories	35 Ft./2.5 Stories
Street Facing Entrance	Yes
Roof Type	Gable, Mansard, Flat
Building Outdoor Amenity Space	1/Res. Unit
Façade Composition (Street or front facing building elevation)	
Fenestration Ground Floor (Min.)	15 - 50%
Fenestration Upper Floor (Min.)	15 - 50%
Blank Wall (% of front façade without fenestration)	Not Applicable
Parking	
Primary Street Front Setback (Min.)	Behind Front Façade
Side and Rear Setback (Min.)	5 Ft.
Parking Ratio	1 - 2 Spaces Per Residential Unit
Typical Residential Density	
Gross Density	12 - 20 Res. Units/Acre
Additional Design and Development Guidelines	
1. Townhouses typically have stoops on the front façade and a private dooryard/garden or a shared common between the building and street line.	
2. No more than 8 residential units may be attached without a space of at least 20 feet between another group of attached residential units.	
3. The front facades of individual units can be staggered as much as 4 feet with recessed or projecting bays along the street line.	

* Not all residential buildings will be located on a separate lot such as in condominium developments. Where separate lots do not exist, the side and rear setbacks should be doubled to determine appropriate space between primary buildings.

FIGURE 4.6.7 - MIXED USE BUILDING DESIGN GUIDELINES

Definition	Diagram
<p>A moderate floor plate, multi-story principal building type with ground story commercial uses and the occupancy of upper stories for permitted uses including residential units at a scale that is compatible and complimentary to its given district.</p>	
Character Examples (For illustrative purpose only)	
	
Typical Specifications*	
Lot Dimensions	
Lot Area	
Rear or No Driveway Access	Not Required
Front Driveway Access	Not Required
Lot Width (Min.)	
Rear or No Driveway Access	30 Ft.
Front Driveway Access	50 Ft.
Lot Depth (Min.)	60 Ft.
Lot Development	
Lot/Area Coverage by Impervious Surface (Max.)	80%
Lot/Area Outdoor Amenity Space (Min.)	15%
Building Placement	
Primary Street Front Setback	2 - 12 Ft.
Secondary Street Front Setback	2 - 12 Ft.
Side Setback (Where no common wall exists)	8 - 12 Ft.
Rear Setback/Alley, Access St. or ROW	2 Ft.
Rear Setback/Residential District	50 Ft.
Building Separation (Min.)	Not Required
Building Size and Massing	
Residential Units Per Building Type (Max.)	1 - 16 Res. Units
Building Footprint (Max.)	Not Applicable







Typical Res. Unit Gross Floor Area (GFA)	<2,700 S.F. Per Res. Unit
Typical Res. Unit Living Area (L.A.)	400 - 1,500 S.F.
Front Façade Width	30 - 150 Ft.
Front Façade Build Out (% of Building to Lot Width)	80% Primary Frontage; 65% Secondary Frontage
Front Façade Off-Set (Articulation Per Linear Foot)	4 Ft Recess/Projection Per 50 Linear Ft. Feet
Building Depth	60 – 100 Ft.
Ground Floor Elevation (Above Ground Plain)	0 Ft. or Full ADA accessibility
Ground Floor Story Height (Min.)	12 Ft.
Upper Story Height (Min.)	10 Ft.
Building Height/Number of Stories	30 Ft./2 Stories
Street Facing Entrance	Yes
Roof Type	Gable, Hip, Flat
Building Outdoor Amenity Space	1/Res. Unit
Façade Composition (Street or front facing building elevation)	
Fenestration Ground Floor (Min.)	70%
Fenestration Upper Floor (Min.)	15 - 50%
Blank Wall (% of front façade without fenestration)	20 Linear Feet maximum
Parking	
Primary Street Front Setback (Min.)	Behind Front Façade
Side and Rear Setback (Min.)	3 Ft.
Parking Ratio	1 - 2 Spaces Per Residential Unit
Typical Residential Density	
Gross Density	12 - 20 Res. Units/Acre
Additional Design and Development Guidelines	
1. Parking can be integrated within the building footprint either at grade or below grade; Tandem parking can be provided for individual residential units.	
2. See Design Guidelines for Town Center and Outdoor Amenity Spaces in the Planning Board Zoning Regulations	

* Not all residential buildings will be located on a separate lot such as in condominium developments. Where separate lots do not exist, the side and rear setbacks should be doubled to determine appropriate space between primary buildings.

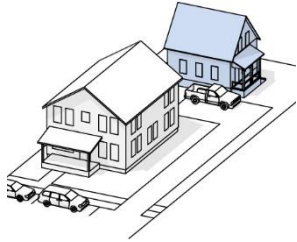
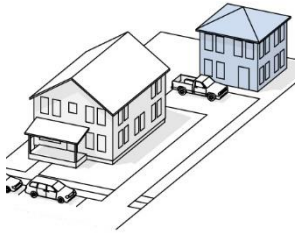
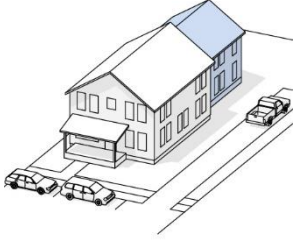
4.7. ACCESSORY DWELLING UNITS AND COMMUNITY BUILDING TYPES



A. Accessory Dwelling Units (ADU). ADU types and design guidelines are defined in Figure 4.7.1 below.

FIGURE 4.7.1 - DESIGN GUIDELINES FOR ACCESSORY DWELLING UNITS AND HOME-BASED BUSINESSES

1. ACCESSORY DWELLING BUILDING TYPES AND DEFINITION				
	Backyard Cottage (GC)	Carriage House Unit (CHU)	Integrated Units (IU)	Penthouse Unit (PU)
1.1 BUILDING DIAGRAM				
1.3 CHARACTER EXAMPLES				
1.2 DEFINITION	A detached accessory residential building with one (1) residential unit intended for a single family.	A detached or semi-attached accessory residential building that includes a residential unit combined with a garage or home business. Carriage House Units have separate entrances and are located to the rear of the main house.	An attached accessory residential unit located within the side or rear of the main house or within the existing footprint of the main house and with a separate entrance.	An accessory dwelling units on the rooftop of a commercial building in a commercial district.

2. ACCESSORY DWELLING/BUILDING DESIGN GUIDELINES					
		Backyard Cottage (GC)	Carriage House Unit (CHU)	Integrated Units (IU)	Penthouse Unit (PU)
2.1	Building Width	12 Ft Min./20 Ft Max..	30 Feet Max.	90% of Main House	60% of Main Building
2.2	Building Depth	30 Feet Max.	60 Feet Max.	50% of Main House	80% of Main Building
2.3	Total Stories	1.5 Max.	2.5 Max.	2.5 Max.	1 Max.
2.4	Total Height	20 Feet Max.	30 Feet Max.	30 Feet Max.	12 Feet Max.
2.5	Res. Unit Living Area (L.A.)	900 S.F. Min.	900 S.F. Min.	900 S.F. Min.	900 S.F. Min.
2.6	Total Area (GFA)	1,400 Gross Floor Area	75% of Main House	40% of Main House	40% of Main Building
2.7	Building Footprint (Max)	NR	75% of Main House	40% of Main House	40% of Main Building
2.8	Roof Type	All	All	All	Flat, Shed
2.9	Ground Story Fenestration	20% Min.	20% Min.	20% Min.	20% Min.

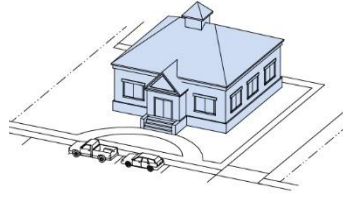
B. Residential Development Community Buildings. See Figure 4.7.2 Below.

TABLE 4.7.2 - DESIGN GUIDELINES FOR RESIDENTIAL COMMUNITY BUILDINGS		
1 ACCESSORY BUILDING TYPES AND DEFINITION		
	Community Building (CB)	
1.1 BUILDING DIAGRAM AND CHARACTER EXAMPLE		
1.2 DEFINITION	A detached accessory building located and designed for common use and enjoyment such as for social, educational, recreational, and similar community activities.	
2. BUILDING DESIGN GUIDELINES		
	Community Building (CB)	
2.1	Building Width	NR
2.2	Building Depth	NR
2.3	Total Stories	1.5 Max.
2.4	Total Height	30 Feet Max.
2.5	Res. Unit Living Area (L.A.)	NR
2.6	Total Area (GFA)	100% of the Largest Res. Unit in the Development
2.7	Building Footprint (Max)	100% of the Largest Res. Unit in the Development
2.8	Roof Type	All
2.9	Ground Story Fenestration	20% Min.

C. Home Based Accessory Business Units. Accessory home based businesses and accessory structures should flow the design standards for accessory dwelling units in Figure 4.7.1 above.

4.8. SIGNAGE STANDARDS

Signage for residential developments should be functional and attractive. Site signage must comply with the Sign Regulations in **Article 9 of the Zoning Bylaw**. These guidelines focus on well-designed signage in the context of compliance with applicable regulations.

A. General Guidelines. Signage for residential developments should identify the community, promote a positive image, and harmonize with its surroundings.

1. Reinforce New England Character. Sign design should be appropriate to Winchendon’s traditional New England character. Historic characteristics should be used such as

muted colors, traditional font styles and sign faces, materials such as wood or wood composite, and lettering that is painted, carved dimensionally, vinyl cut, sand-blasted, etched, or metal channel-cut.

2. Emphasize Legibility and Clarity. A sign should be readable, simple, and legible, with careful consideration of the proportion of lettered and graphic areas to the overall size and location of the sign, and consideration of the purpose and intended audience of the sign. Lettering should be concise and graphically balanced. Generally, a sign's text and graphic elements should not occupy more than two-thirds of the sign panel area.
3. Focus Signage Content. Signage messaging should be simple and brief. Signage should communicate only the name of the residential community and/or wayfinding within the community. Signage may also include home occupation businesses that should be respectful of the residential context.
4. Use Signage Color. Signage color should complement building materials and color palette.
5. Coordinate Signage Materials. Signage materials should be selected for durability, ease of maintenance, and compatibility with building materials and design.

B. Sign Harmony.

1. Reinforce Compatibility with Context. Signs should be designed to be compatible with neighboring properties through sign style, height, type, scale and location. Illumination should be designed to minimize impact on adjacent residences.
2. Coordination with Building Architecture. Sign design and placement should relate to and harmonize with the building architecture. Signs should not overwhelm or obscure building features.

C. Site Signage.

1. Integrate Signage Design with Landscape. Site signage should be integrated with site landscape design and be used to reinforce gateway locations and site entry points. Landscape plantings should be included to anchor and integrate signage into the site plan.
2. Simplify Development Signage. Signage should indicate the overall residential development and community name or branding features. This type of signage should be balanced and in scale with both the overall scale of the development and the surrounding context. Signage for individual single-family and two-family homes is discouraged unless they are part of an agricultural business.
3. Minimize Wayfinding Signage. Simple directional signage may be provided on the site to inform visitors of entries, parking areas, or other information. Wayfinding signage

should be consistent and compatible with other development signage. Wayfinding signage should not obstruct or cause conflict with regulatory or traffic-related signage.

D. Sign Illumination. External signage illumination is encouraged and should be targeted only onto the sign, not onto adjacent buildings or towards vehicles or pedestrians.

1. Minimize Signage Lighting Fixtures. External lighting fixtures that project the light from above or below the sign are strongly encouraged. Light fixtures should be simple and unobtrusive and should not obscure the sign’s message and graphics. Raceways, conduits, and other electrical components should be concealed from public view.
2. Provide Consistent Lighting Levels. Lighting should provide a consistent and even wash of light across the sign.



5.0 COMMERCIAL, INDUSTRIAL, AND MIXED-USE DEVELOPMENT

5.1 PURPOSE AND INTENT

The purpose of these design standards and guidelines are to promote sustainable, functional, and aesthetically pleasing development within Winchendon’s commercial, industrial, and mixed use zoning districts. These guidelines and standards are intended to provide guidance to landowners, developers, and businesses who currently own or are proposing development in commercial, industrial, or mixed use zoning districts (Planned Development) and are expected to:

- A. Enhance the relationship and design of buildings, parking, access, landscape, open spaces, site circulation, and the interface with other buildings and properties.
- B. Create a strong relationship with the “public realm” which are the spaces between buildings and within the public right-of-way including sidewalks, open and community spaces, landscaping, and streetscapes.
- C. Ensure opportunity for both small and large-scale commercial, industrial, and mixed use development through a diversity of building sizes and a mixture of uses.
- D. Recognize traditional architecture with the potential for compatible diversity while defining expectations for new development, allowing for flexibility, and fostering high-quality design.
- E. Incorporate the highest sustainable and ecological best practices through the use of advanced green and healthy building technologies and materials that promotes high-performing buildings.
- F. Promote an attractive and pleasant place to work, do business, recreate, eat, shop, learn, be entertained, and visit.

5.2 APPLICATION

Development projects requiring site plan approval by the Planning Board within the zoning districts identified below shall be subject to the design standards and guidelines in this section:

A. Industrial Districts.

1. Industrial District (I)

B. Commercial Districts.

1. Highway Commercial District (C1)

- 2. Neighborhood Business District (NB)
- 3. Mill Conversion Overlay District (MCOB)
- 4. Gateway Overlay District (GAOD)
- 5. Route 140 Corridor Overlay District (Rt. 140 COD)

C. Town Center Districts.

- 1. Planned Development District (PD)

D. Pre-Application Phase. Applicants are encouraged to meet with the Director of Planning and Development prior to submitting a formal development application to the Planning Board and formal review. During the pre-application phase, both site and building designs can be discussed as they relate to these Sustainable Development Standards. The objective is to provide an open discussion and a mutual understanding of both the development opportunities and challenges posed by a particular site and development program. This type of dialogue can enhance the efficiency of the approval process and outline design directions that are mutually beneficial to the Town and applicant. At any point in the process, the Winchendon Planning Department is available for permitting guidance and assistance.

5.3 GENERAL DESIGN STANDARDS FOR ALL DEVELOPMENTS

A. Cluster Site Development Components. The site components such as buildings, parking areas/structures, and outdoor amenity spaces should be clustered to maintain the maximum amount of natural and undisturbed area on the property, and landscape buffers at property boundaries where necessary.



B. Appropriate Streetscaping. Streetscaping within the front setback should visually enhance the public realm, be calibrated to the scale of the space, and complement the aesthetics of the building. High-quality surfaces, furniture, and landscape material should be combined to create beautiful open spaces that engage the pedestrian. Plants that are native and drought-resistant are highly preferable.

C. Streetscapes and Native Landscapes. Development sites should include a hierarchy of landscape that contributes to the overall site design and integrates with adjacent properties and the public realm of streets, sidewalks and civic spaces. The hierarchy should include an entry and gateway landscape, buildings landscape, streetscape, and landscape buffers where appropriate.

1. Define Entry and Gateway Landscapes. Entry and gateway landscaping should be used to define site access and reinforce a sense of arrival and layout of the site.
2. Integrate General Site Landscaping. Landscaping should integrate buildings and other components into the overall site plan by softening building edges, enhancing pedestrian walkways, building entries, and improving outdoor amenity spaces.
3. Coordinate Landscape at Street Frontages. The landscape along the site frontages on public streets should contribute to the character of the street and reinforce a consistent and integrated pattern, character, type, and spacing of landscape improvements.
4. Provide Screening and Buffering as Applicable. Landscape buffers, screening, and fencing should be used to conceal utility areas such as dumpsters, recycling areas, stockpiling and storage areas, surface parking, loading and services areas, maintenance yards, and other similar uses from pedestrian views, public streets, and property lines.
5. Integrate and Coordinate Functional Features into Landscape.
 - a) Stormwater retention areas should be integrated with the site landscape and treated as a naturalized areas.
 - b) Retaining walls, fencing, and other utilitarian or screening features should be design and integrated with the landscape design and contribute to the site character, and considered for views of them from adjacent properties.
 - c) The materials used for functional features, such as retaining walls, drainage structures, or other required site elements, should be integrated with the overall site design and material palette. For example, a functional retaining wall should include stone facing to match stone walls on the site.
 - d) Utilities or other utilitarian components should be screened from public view with landscape treatments.
6. Use Native Landscape Plantings. Landscape plantings should be selected and installed in accordance with best practices for Winchendon’s plant hardiness zone of 5a.

FIGURE 5.X.X – LANDSCAPE AND STREETScape		

D. Access and Parking. When designing access and parking, developers should consider the pedestrian first, then cyclists, then transit, and then the automobile. Site access should provide clear and legible routes for all modes of transportation to connect to the site and to enter internal site circulation systems. Parking should be conveniently located to the building entries while maintaining pedestrian safety, attractiveness, and aesthetics of the site. Attention should be paid to the appearance of the exterior areas where landscape screening

may be appropriate. For specific parking requirements refer to the Parking Regulations in Article 8 of the Zoning Bylaw.

1. Minimize Site Access Points. The number and width of vehicular access points into and out of the site should be minimized. Where vehicular access drives cross pedestrian routes, pedestrian crossings should be marked and differentiated with variations in paving materials (for example by using stamped concrete or asphalt). Refer to the Winchendon Department of Public Works for additional requirements. Access driveways that cross a public sidewalk should address pedestrian and cyclist safety and located so as not to adversely affect traffic.
2. Internal Connections. While roads and sidewalks are the primary way people access a site, connections to adjacent buildings and parking areas increases efficiency and removes traffic from the streets and should be made where appropriate.
3. Pedestrian Connectivity. Inviting and efficient sidewalks should be provided along any and all street frontages at the site perimeter. Additionally, sidewalks and paths should be provided linking public sidewalks to all building entries, parking areas or structures, and outdoor amenity spaces on site.
4. Multi-Purpose Paths. Efforts should be made by developers to include bike paths within or adjacent to a site where the opportunity exists. Developments should anticipate future connections to the Winchendon Rail Trail and other cycle facilities that intersect with the Industrial Districts and incorporate them in the site plan.
5. Parking Placement. Surface parking lots in the development should be located at the middle or rear of development parcels and shielded from the public right-of-way by the building, street trees and native landscaping. Most parking should be located to the rear and parking in front of buildings is discouraged. Parking placement should also consider existing or potential future shared parking opportunities with adjacent developments.
6. Parking Perimeter Buffers and Screening. Provide a mix of deciduous and non-deciduous plantings of adequate height and density to visually screen surface parking lots from the public sidewalk and adjacent residential neighborhoods where applicable.
7. Parking Interior Landscaping and Access. Landscaping required for parking areas in **Article 8** of the Zoning Bylaw must be adhered to. Additional landscaping guidelines for parking areas in the development follow:
 - a) Incorporate shade trees and native, drought-tolerant plants of varying heights/species at parking islands and along edges to diminish the heat island effect.
 - b) Include dedicated irrigation where feasible. Employ plantings of adequate height and density so as to visually buffer parking when it is unable to be located in a manner that makes it less visible from the public way.

- c) Include internal walkways and curb extensions between the parking lot, building, and public sidewalks.
- d) Provide curb extensions where pedestrians are required to cross driveways and parking aisles.

FIGURE 5.X.X – PARKING PLACEMENT, ACCESS AND LANDSCAPING		

8. Coordinate Service, Delivery and Loading Access. If separate service, delivery or loading access is required for site development operations it should be clearly distinct and distinguished from other forms of site access. Functional access that is required for appropriate site operation should not be combined with other uses but should be coordinated with safe pedestrian routes and crossings on the site. Loading zones/docks should be located so as not to be visible from the primary public way. They should be visually shielded using attractive, high-quality fencing and/or vegetation.
9. Structured Parking. Structured parking is located above grade or underneath a building. It should not face the primary frontage unless it is designed to appear like a building, but instead be located towards the rear of a building and shielded by public view where possible. Exposed portions should be naturally ventilated and visually softened with landscaping, architectural screening, open spaces, and pedestrian entrances. Design standards for above ground parking structures are as follows:
 - a) Access. Pedestrian access to structured parking should be made directly to the primary building and to a public sidewalk as applicable. Structured parking may be attached directly to primary buildings allowing pedestrians to enter directly into the building. Parking structures may be shared by multiple properties to meet off street parking requirements.
 - b) Design and Construction. Where a structured parking facility is visible from a public street, the design of the visible façade(s) must be meet the follow standards:
 - 1) Facade door and window openings must be vertically and horizontally aligned and all floors on the front side of facade facing the street must be level (not inclined).
 - 2) The facade must include transparent or translucent on the ground floor. Non-reflective glass or openings designed to appear as windows may be used within twenty percent (20%) to fifty percent (50%) of the wall area.
 - 3) The facade area masking the floors occupied by motor vehicle parking must be seamlessly integrated into the architectural design of the building's facade.

- c) Commercial and Amenity Uses. The ground level and top level may be used for publicly oriented commercial purposes such as retail stores and restaurants, and outdoor amenity space as provided for in **Section XX** below.
- d) Below-Grade Structured Parking. *Below-grade structured parking is located partially or fully underground. Where possible, below-grade parking should be naturally ventilated, and any portions that are visible above grade should be clad in high-quality materials.*

FIGURE 5.X.X – STRUCTURED PARKING DESIGN

FIGURE 5.X.X – STRUCTURED PARKING DESIGN		

STRUCTURED PARKING WITH SOLAR PANELS

Restaurant on Top of Parking Garage Streetscape, Louisville, KY

10. Share Parking Where Possible. Shared parking increases development efficiency and potential while diminishing the overall impact of the automobile. Developers should always investigate shared parking opportunities with adjacent property owners.
 11. Bicycle Storage. All developments should include externally located bicycle racks easily accessible from the public way as well as protected and secure bike storage for employees.
 12. Car Sharing and Charging Stations. Parking areas should incorporate spaces reserved for car sharing programs as well as vehicle charging stations. Developers should consider installing shading devices with imbedded solar cells to provide power and reduce solar gain.
 13. Transit Service and Facilities. Developers should consider opportunities for shared shuttle service and bus transit pull outs or shelters where appropriate on larger properties and where improvements are anticipated in the public right-of-way along the site's frontage.
- E. Signage.** Signage in the development must meet the requirements in Article 9 of the Zoning Bylaw and **Section 6 of the Design Guidelines**. The design objective for signage in the commercial, industrial, and mixed use districts is for businesses to communicate a positive and clear identity for the facility, be part of the building and façade design, harmonize and reflect the character of its surroundings.
1. Promote Legibility and Clarity. Signage should be readable, simple, and legible, with careful consideration of the proportion of lettered and graphic areas to the overall size and location of the sign. Consideration should be given to the purpose and intended audience of the sign. Signage should be concise and graphically balanced.

2. Define Hierarchy of Signage and Purposes. The most important sign and most important information on a sign should be the most prominent and emphasized component of the sign. Secondary and support information should defer to the most important information. Sign design should optimize communication.
3. Coordinate Signage Type and Scale. Signs should be scaled to their use and intended viewer. Sign lettering and graphics should be clear, simple, and legible from a distance, under different lighting conditions. Scale of signs should be appropriate for its intended audience and its location on a building or site. Automobile-oriented signs should be legible at posted driving limits.
 - a) Free-Standing Signs. Free-standing signage should be designed to complement the overall character and design of other site and building components.
 - b) Building Signage. Signage should be specifically integrated into elements of a building's architecture. Careful attention should be given to ensure the detailing, material palette, scale, and proportions of these types of signage match the architecture of the building in an integrated way. Their design and placement should be outlined in the building's construction documents.
 - c) Monument Signs. These freestanding signs are the most appropriate for business parks and large scale commercial office or retail buildings. Monument signs have a low profile with no open space between the ground and the sign. The foundational structure should be constructed of masonry materials and the sign board should be integrated into the foundational structure or on top of the foundation but within the overall height limit of five (5) feet. Sign boards should have a maximum length of ten (10) feet, constructed of durable materials, and illuminated by an external source of light. The front edge of a monument signs should be located no closer than five (5) feet from the front and side property line and integrated with the streetscape and landscape treatments.
 - d) Pedestrian-Oriented Projecting Signs. Projecting signs perpendicular to the building along the public street right-of-way line are highly visible to motorist, pedestrians and cyclists, and create a more interesting and engaging public realm. Projecting signage encompasses all signs that are permanently affixed to a building along the street line and project out toward the street and sidewalk. They can be an element such as an awning or canopy. Projecting signs are highly encouraged pedestrian oriented commercial developments (i.e. the Planned Development District) and should be designed to reflect the type of the business. Their scale, level of detail, and proportions should be calibrated with that of the building and should be scaled for the pedestrian experience.

4. Integrate Signage Design with Landscape. Site signage should be integrated with site landscape design and be used to reinforce gateway locations and site entry points. Landscape plantings should be included to anchor and integrate signage into the site plan.
5. Coordinate Signage Placement. Sign locations should consider site characteristics in regard to roadway and access points, building location, views in and out of the property, pedestrian and vehicular circulation, and vehicular safety and visibility.
6. Materials and Colors that Complement the Building. Signs should be conceived of as an integral part of a building’s architecture, and as such designed with the same degree of consistency and attention to detail that is employed for the larger building. The colors, materials, and the overarching aesthetic of a sign should work seamlessly with the architecture to create a visually harmonious façade. The design and materials employed in a building’s signage should be illustrated both on renderings for the building, as well as in the construction documents.
7. Sign Lighting. Lighting for exterior signage in the development should be from a secondary source. This prevents unwanted light from spilling into adjacent properties and avoids the cheap appearance of lighted box signs. The fixture chosen to light the sign should be either hidden from view or complement the architecture of the building. Internally lighted or animated signs are discouraged.

FIGURE 5.X.X – SIGNAGE		

Free Standing Monument

- F. Site Lighting.** Site lighting is intended to provide safety in areas with evening activity, particularly near-site and building entries and across parking lots. It is also intended to provide a minimum level of lighting for nighttime safety. Lighting design must comply with the lighting requirements in **Section XXX** of the Zoning Bylaw.
1. Minimize Lighting. Site lighting should not provide lighting in excess of requirements. Downward-directed, dark-sky compliant lighting is required as per the lighting requirements of **Article XX** of the Zoning Bylaw to minimize excess glare and spillage.
 2. Integrate Lighting Fixtures with Design. Lighting fixtures should be selected to contribute to the overall character of the building and site, and within a consistent design theme.

FIGURE 5.X.X – SITE LIGHTING		

--	--	--

G. Building Placement and Orientation.

1. Building Setbacks from the Street ROW Line. The size and height of buildings along the frontage should be adequately scaled to the components within the street right-of-way such as the width of the street (curb-to-curb), tree belts and planting strips, and pedestrian and bike facilities.
2. Building Frontage Zone (BTZ). The setback area between the front façade of a building and the street right-of-way line is the Building Frontage Zone (BFZ). These areas should be occupied primarily by Outdoor Amenity Spaces as provided for in **Section XX below.** The BTZ may also accommodate additional sidewalk circulation, cycle tracks, street trees and stormwater planters, landscaping, street furniture, bicycle racks and corrals, and other elements. Together with street right-of-way components, BTZ enhancements should expand activity within the “public realm” and contribute to a vibrant, walkable district.
3. Side Setbacks Connections. Side setbacks provide opportunities to introduce greater permeability to a site through cross-site connections. These links allow pedestrians, cyclists, and vehicles to pass from the public street corridor into the development site, and where appropriate, adjacent properties that share access. Side setbacks are also appropriate for shared Outdoor Amenity Space with visibility and connection to the public street.
4. Rear Setbacks. Rear setbacks should be utilized primarily for parking, loading and utility space necessary for building uses. Developers should also consider opportunities for Outdoor Amenity Space, particularly trails and pathways that can become a shared amenities with adjacent properties and part of a network in the district.
5. Pass-Throughs. Buildings should accommodate pedestrian and cyclist pass-throughs in order to diminish the wall-like nature of long buildings along the frontage. Pass-Throughs increase site circulation and permeability and can serve as an Outdoor Amenity Space for both patrons and employees. Bridged or archways between buildings can also act as pass-throughs and are encouraged. New connections should link into existing streets and paths, as well as parking areas and Outdoor Amenity Spaces on site.

FIGURE 5.X.X – BUILDING PLACEMENT AND ORIENTATION		

H. Building Height. The visual impacts of building heights are shaped by a variety of factors including the individual floor to floor dimensions, the type of construction, the contours of a site, intended uses, and the scale of the surroundings. Taller buildings will appear less tall when setback or stepped back from the street right-of-way line. Employing subtle materials will help to visually reduce the presence and apparent height of the building, and attention should also be given to how the top of the building is visually terminated. The following guidelines for reducing the potential impacts of height in the commercial and industrial districts should be considered:

1. Building Setbacks and Stepbacks from the Street. Building stepbacks visually obscure upper levels of the building as viewed from the street or sidewalk, and to diminish the perceived height of a building. The setback or stepback allows for an adjustable amount of “street enclosure” along the street right-of-way in a commercial or industrial district. The impact of height can be diminished when upper floors are offset (or stepped back) from the façade and story below, or by the inclusion of Outdoor Amenity Space in front of the Building Frontage Zone. Developers are encouraged to utilize the building stepback as a functional space such as for green roofs, gardens, terraces, seating areas, and other amenities that can benefit employees, visitors and customers.
2. Minimize Shadow Impacts. New developments should minimize negative impacts, such as casting shadows on adjacent properties or streets. Developments should not cause significant shadows for extended periods on civic spaces and outdoor amenity spaces.
3. References to Height in Context. Developers should consider the heights of adjacent buildings or the potential for new development on adjacent properties. This does not limit the height of proposed buildings but rather seeks to foster greater visual harmony between new projects and the existing or anticipated fabric.
4. Parapets/Cornices. Parapets are the portions of the exterior walls of the building that continue vertically past the roof plane. They are sometimes capped by a linear, projecting architectural element called a cornice. Where appropriate, they should be used to create a variation in heights of different segments of the building as well as visually screen smaller rooftop mechanicals.
5. A Range of Building Heights. The height of large buildings should vary to add variety and visual interest, as well as to break down its massing. In smaller buildings, the degree of variety may be less such as small changes to the height of the parapet. In large developments, height should vary by a minimum of a full story.
6. Roof Pitch. Flat and pitched roof are the more appropriate roof forms in commercial and industrial districts with predominantly retail, light industrial, technology, and life science uses. While all roofs have some degree of pitch, flat roofs generally have no discernible slope and are often paired with parapets. Sloped roofs have visibly discernible pitches and can be an important feature of the building’s design.

7. Mechanical Penthouses. Mechanical systems on building rooftops should be shielded from public view by visual screening from the street. A penthouse should be designed to be compatible with the aesthetic and material design of the building and centered on the building where possible.

FIGURE 5.X.X – BUILDING HEIGHT		

Setbacks and Stepbacks Rooftop Mechanical Screening

- I. **Building Massing.** Building massing should be designed to reduce the overall perceived scale and provide simple and evocative forms that reinforce a sense of a human-scaled environment. Larger building masses are appropriate in the Commercial and Industrial Districts as greater building height and footprints are allowed in this zoning district. However, development sites closer to established residential areas should consider tapering down the building’s mass to provide a more compatible transition in character.
 1. Scale. The scale of a building is related to the proportion of the components, the overall size, and its relationship to its context. New buildings should reveal different aspects of themselves from different distances and vantage points through articulation and modulation of vertical and horizontal components.
 2. Break Building Mass into Smaller Forms. New buildings in the Commercial and Industrial Districts should be composed of smaller aggregated volumes or a single larger volume that is influenced by adding and subtracting space to and from it. The overall volume of larger buildings should be broken down into smaller masses to create a more visually interesting building. Adding or subtracting elements helps to create depth and shadows and lends the building a more human scale. Additive Elements include projecting bays, terraces, and balconies. Subtractive Elements include recessed terraces or forecourts alcoves, and other stepbacks, and serve to punctuate the facade and create depth using shadows. By varying the roof height, façade plane, setbacks, and floor-to-floor height, a large, monotonous building can be made to appear as a collection of smaller ones that are more pedestrian appropriate in their scale. These various elements and applications should be scaled and detailed to blend with the overall aesthetic of the building.
 3. Linear and Vertical Elements. New buildings should be designed to “break up” what are typically long, horizontal facades, vertical elements such as stair and elevator cores by externally expressing them in ways that diminish a building’s linear presence. Other elements that should be arranged to mitigate horizontal monotony are windows, balconies, alcoves, and solar shading devices. Creating articulated vertical divisions in the facade can also help to create the appearance of multiple, aggregated buildings as opposed long monotonous walls.

FIGURE 5.X.X – BUILDING MASSING		

Vertical Modulation and Articulation/ Horizontal Modulation and Articulation

J. Façade Treatments. The character of a building facade depends on a number of factors: the proportion and orientation of openings, the composition of the fenestration, the color and patterning of the exterior skin, and the relationship between the various parts of the exterior. Preferences in architectural style varies but what matters most in a building’s elevation is quality and consistency. Durable, high-quality materials will add to an expression of the quality and character of a building.

1. Break Up Building Lines. Long, monotonous facades can lack a human scale. New buildings should break up vertical and horizontal building lines so that large masses appear to be composed of smaller, discrete volumes. These can be achieved through variations in the depth, changes in material, aggregating architectural elements, and by additive/subtractive processes. Stepbacks, bands of windows, awnings, canopies, and balconies can also visually divide a building into smaller masses.
2. Create Solids and Voids in the Façade. Windows, recesses, and similar elements are visually read as “voids” that have been subtracted from the “solid” volume of the building. The ratio of solid to void should be calibrated to the needs of the uses within the building.
3. Create Projections and Recesses in the Façade. Commercial and industrial buildings should be designed to create depth and variety in a façade. This should be achieved through the introduction of projections and recesses. Projections can take the form of bay windows, balconies, and solar shading. Recesses encompass subtractive elements such as alcoves, balconies, terraces, stepbacks, galleries, and arcades.
4. Emphasize Corners. Corner conditions are an important part of a facade. Creating multi-story facets, vertical corner elements, bays, or subtractions help to punctuate the corner. Increased height may be appropriate to further emphasize the importance of a critical corner of the building.
5. Emphasize Entrances. Where appropriate, entrances should be located frequently along the primary street frontage and be designed in a way that is welcoming to the general public. Entrances should provide protection from the elements and be clearly designated with appropriate signage.
6. Ground Floor Windows and Glazing. As appropriate, windows on the ground floor facing the street should be large and highly transparent to provide views within the buildings from the sidewalk and allowing for natural light to penetrate the interior space.

7. Upper Floor Windows and Glazing. Windows on upper levels should be arranged and aggregated to create larger patterns along the façade and a sense of order and visual rhythm while serving to break down the scale of the building.
8. Add Balconies and Terraces. Creating depth in the facade adds interest through the interplay of light and shadow, as well as visually breaking down the massing. This can be achieved through additive or subtractive means. Balconies are additive elements that need to be carefully integrated into the architecture so as not to appear “tacked-on” or an afterthought. Terraces act in the opposite way, carving out the volume from a building to provide exterior spaces. These appear as voids if subtracted from the middle portion of a building, and as stepbacks if carved from uppermost levels.

K. Material Selection. Products and materials that are specified for construction should be selected based on their durability, maintenance and recyclability characteristics, energy sources and consumption profile, and with respect to their performative and sustainable qualities. Durable and natural materials ensure that the building is built for the long-term. General guidelines for material selection and application in the Commercial and Industrial Districts are as follows:

1. Locally Sourced Materials. Whenever possible, materials should be selected from locally sources, have a low embodied energy content and be recyclable. Using local materials reduces the transportation and distribution costs of the product. Products that reduce raw material use should be chosen because of their resource conservation. Zero or low-emission building products should be specified to improve air quality. The durability and aesthetic value of a material is intrinsically related to its quality. Choosing high-quality materials ensures that the buildings last. Locally sourced materials offer an additional layer of benefits by supporting the local economy, reducing the energy involved in transportation, and being a product of the region.
2. Recyclable, Low Embodied Energy Materials. The carbon footprint of a material is a product of the cumulative amount of energy invested in it over its lifespan, including the harvesting of raw materials, refinement, production, transportation, and disposal. Choosing materials that require lower levels of energy at each stage of this process can substantially lessen its environmental impact. If the product is designed to be recycled, this reduces the energy needed to harvest raw materials in its next iteration.
3. Texture, Variation and Tactility. Natural materials such as wood, glass, and stone are recommended in the Industrial District. These materials read as monolithic from a distance but revealing variations in tone and texture as one moves closer towards them. Selecting the right combination of materials for the façade of a building requires a balance between too few which may look uninteresting and stark, and too many which can appear overstimulating and busy.

4. **Ground Level Materials.** The quality of materials and detailing at a building's ground level should be the highest, as this is the level that the public will primarily interact with. It should incorporate large amounts of glazing, attractive signage, and deploy awnings and canopies to protect people from the elements and visually denote entrances. The glazing should ideally be low-e and low-iron, and mullions should be placed to reinforce horizontal and vertical composition lines.
5. **Upper Levels Materials.** In the upper levels of taller buildings with detailed eaves, materials should be selected that complement the level of detail on the ground level and draw the viewer's eye upward. In the upper levels of buildings that visually downplay height with stepbacks, sloped roofs, or structural breaks, materials should be chosen that visually recede with more restrained details.
6. **Paving.** Paving materials used to create sidewalks, plazas, terraces, and other hardscapes should be natural materials such as stone, or patterns using colored concrete. This can foster a stronger sense of place and create a more interesting pedestrian experience. These surfaces and material selections should facilitate movement for persons with disabilities.

FIGURE 5.X.X - MATERIALS

- L. **Building Lighting.** Building lighting should be functional, energy efficient, and designed to feature key components of the building or site that need nighttime light. Lighting design must comply with the lighting requirements in Section XXX of the Zoning Bylaw. Additional guidelines are as follows:
 1. **Minimize Quantity of Lighting.** Illumination levels should be provided at the minimum level that is required to provide the function desired.
 2. **Coordinate Light Fixture Design.** Lighting fixtures should be selected to contribute to the overall character of the building, and consistent with the overall design of the site development.

FIGURE 5.X.X – BUILDING LIGHTING

- M. **Outdoor Amenity Spaces.** The goal for outdoor amenity space in the Commercial and Industrial Districts is to create a broad range of quality private and publicly-oriented open spaces that contribute to the vitality of the district and provide opportunities for employees, visitors, and residents to enjoy passive and active recreational spaces. See Section 7 for specific outdoor amenity space design standards.

N. Sustainable Design. The goal of sustainable design applications in the Commercial and Industrial Districts is to effectively balance environmental, economic, and aesthetic objectives through a range of best practices.

1. Low Impact Development / LEED Certification. All new developments are encouraged to meet certification standards under Leadership in Energy and Environmental Design (LEED) sustainability rating system for buildings and sites.
2. High-Performance Building Skin. As applicable, new buildings should use of low emissivity windows, high R-value spray insulation, reduced thermal bridging, adequate depth exterior walls, solar shading, and sustainable cladding which all contribute to a high-performance building envelope.
3. Plant Trees. Trees reduce solar gain, provide shade for pedestrians, filter the air, convert CO₂ to oxygen, provide habitat for birds, and absorb stormwater on site. Industrial developments should provide ample canopy trees that are located to allow grow to their mature size and specify measures to ensure sufficient space for water penetration and root growth.
4. Green Roofs and Walls. Green roofs and walls reduce storm water runoff by absorbing and then slowly releasing rainwater. They protect the underlying roof, reduce solar gain during the summer months, and provide habitat for wildlife. If located on a lower roofs or walls of the building, they can also be a visual amenity. These sustainable application are highly recommended in the Commercial and Industrial District.
5. Rain Gardens and Permeable Pavers. Storm water, flooding, and ground water recharging are important site planning issues in the Commercial and Industrial Districts. New developments should incorporate natural elements to create resilience such as rain gardens that temporarily retain storm water until the ground can adequately absorb it. Permeable paving is also recommended to allow rainwater to naturally leach into the ground and recharge the water table. These sustainable applications reduce flooding and stress on public infrastructure, replenishes aquifers, filters out pollutants, and helps keep trees healthy.
6. Sustainable Outdoor Amenity Spaces. As applicable, outdoor amenity spaces such as pocket parks, plazas, terraces, and other civic gathering spaces should incorporate light imprint techniques that address the quantity and quality of stormwater on site.
7. Latent and Renewable Energy Sources. In a climate with large seasonal temperature swings, efficient methods for heating and cooling buildings are critical to reducing a building's carbon footprint. As applicable, developers should utilize the latent energy of their sites to meet energy needs such as through the following applications:
 - a) Roof-installed solar panels and solar shades over surface parking lots which produce energy and reduce solar gain.

- b) Geothermal energy which can be captured to offset the large temperature variations between seasons and reduce the thermal loading of the building.
- c) Small roof mounted or pole mounted wind turbines that harness latent energy on site.
- d) Installing energy efficient mechanical systems, appliances, and other devices as a priority.

FIGURE 5.X.X – SUSTAINABLE BEST PRACTICES

DRAFT

5.0 COMMERCIAL, INDUSTRIAL, AND MIXED-USE DEVELOPMENT

5.4 COMMERCIAL HIGHWAY DISTRICT DESIGN STANDARDS

A. Applicability. These design guidelines for commercial zones are applicable to developments located within the Highway Commercial I (C-I), Neighborhood Business (C-II), Mill Conversion Overlay District (MCO), Route 140 Commercial Overlay District (RT 140 COD), and the Gateway Overlay District (GAOD). The design guidelines are also intended to guide Municipal building projects. Generally, the commercial zones represent two contexts for development, smaller-scale neighborhood commercial or mill retrofit districts, and larger-scale automobile-oriented commercial corridors. The C-I, RT 140 COD, and GAOD districts' context is a more automobile-dependent commercial corridor character. The design guidelines are applicable in both contexts and encourage a more sprawl retrofit, diverse, and multi-mobility character through new development and redevelopment.

B. Intent. The design guidelines for the commercial zones are intended to shape commercial development along major corridors to reinforce the following design principles that encourage human-scaled and well-designed developments with New England characteristics:

1. An overall development character that reflects the heritage of Winchendon and highlights features of the development or site that may connect the current design to the Town's history
2. Building massing and site composition with a configuration and appearance that suggest evolution or modification over time through organic and incremental growth.
3. Building scale and site composition that reinforces the human scale of the built environment with buildings that are relatable to the pedestrian and a walkable site design with inviting streetscapes or purposeful open spaces for socializing and gathering
4. Building architecture that is varied and eclectic in style but echoes traditional New England building character in terms of details, materials, and colors

C. Site Improvement Guidelines. The following guidelines outline the site design and layout practices that should be viewed as baseline components for a well-designed commercial development in Winchendon.

1. Site Composition. The development's land planning and site design should provide a thoughtful and responsive approach that adapts the development program and site requirements to the conditions of the land.

- a) *Avoid Strip Development Patterns*. Site design should reinforce multi-mobility and “sprawl repair” by clustering buildings and site utilities, featuring contemporary but compatible architecture, connecting pedestrian corridors, protecting resources, and maintaining existing scenic views.
- b) *Integrate Natural Site Features*. The site design should take advantage of the natural site features by maintaining, incorporating, or adapting the inherent characteristics of the property (topography, landscape features and vegetation, rock formations, stone walls, etc.) to guide and benefit the layout and design of the site.
- c) *Cluster Components*. Site and building components should be clustered to maintain the maximum amount of natural and undisturbed open space on the property.
- d) *Reduce Impact of Parking*. Site layout should be designed to minimize the impact of oversized and underutilized parking lots by reducing visibility (and maximizing building visibility), landscape and streetscape treatments, and safe pedestrian access between the parking area and buildings.

FIGURE 5.X.X – SITE COMPOSITION BEST PRACTICES

2. *Building Orientation*. Buildings should be sited and organized in a concentrated development pattern that frames open space and conceals parking and utilities.
 - a) *Orient Building to the Street*. Primary building facades should be oriented to public street frontages, private street frontages, and/or open spaces.
 - b) *Position Entry to the Street*. The primary pedestrian entries to a building should face the street that provides primary access to the property.
 - c) *Respect Patterns of Context*. Front setback distances should be minimized to encourage a relationship between the building and the primary street frontage. While consideration of the placement of buildings on adjacent parcels should be given, building setbacks should be minimized to avoid sprawling development patterns. Buildings that are located closer to the street and sidewalk reinforce a walkable pattern while improving visibility of both drivers and pedestrians.
 - d) *Articulate Multiple Primary Façades*. For buildings with multiple street frontage orientations, façades should be designed to engage the primary and secondary frontages by including entries and interest for pedestrians and drivers.
 - e) *Anticipate Future Improvement*. Building design and orientation should anticipate that abutting vacant or underutilized land may be a future development opportunity.

Thoughtful attention should be paid to anticipating potential future development that could change the context of a building façade to enhance adjacent relationships and avoid awkward building orientations.

FIGURE 5.X.X – BUILDING ORIENTATION

3. Site Access. Site access should provide clear and legible routes for all modes of transportation (pedestrians, bicycles, vehicles, and public transportation) to connect to the site and to enter internal site circulation systems.
 - a) Minimize Site Access. The number and width of vehicular access points into and out of the site should be minimized. Shared access is highly encouraged. Pedestrian crossings should be marked and differentiated with variations in paving materials (for example by using stamped concrete or asphalt). Refer to **Section XXX** of the Winchendon Planning Board Site Plan Review Rules & Regulations for additional requirements as part of the Street Opening Permit process.
 - b) Connect to Public Frontages. Inviting and efficient sidewalks should be provided along any and all street frontages at the site perimeter. Additionally, sidewalk paths should be provided linking public frontage street(s) to all building entries.
 - c) Connect to Adjoining Properties. To encourage pedestrian access between properties pedestrian pathways should be provided between buildings on adjacent parcels.
4. Internal Site Circulation. Circulation internal to the site should provide clear and legible routes for all modes of transportation to connect to the public way, building entries and other site components.
 - a) Promote Pedestrian Circulation. Internal site vehicular circulation routes should have narrow travel lanes and small turning radii to reduce vehicular traveling speeds and reinforce a safe and welcoming pedestrian environment. At pedestrian crossings and intersections, a further reduction of the travel lane width enhances the pedestrian environment and shortens crossing distance. This is referred to as a curb extension, bulb out, or neckdown at the intersection.
 - b) Define Building Entry Landscape. Landscape at the building entry should be designed to provide a buffer between the building entry and the street or parking lot. The landscape should be used as a transition from a pedestrian entry area to the roadway to enhance safety. (This can also be accomplished by streetscape treatments such as a treebelt between the street and sidewalk).

- c) *Create Efficient Site and Parking Circulation.* Adjoining parking areas should share access drives whenever possible. A well-organized system of drives should be used to shorten pedestrian crossing areas, reduce the amount of paved area, limit gaps between development frontages, and ensure a more efficient flow of traffic.
- d) *Reinforce Existing Circulation Connections.* Existing paths on the site should be integrated where possible into the site circulation network to provide access across or through the site. Site circulation that contributes to connectivity of existing trail systems (Winchendon Rail Trail or others) should be integrated into the site access and circulation.
- e) *Integrate Bicycle Circulation and Connections.* Access and circulation for bicycles on site should be provided for safety and as an amenity with bike stands or corrals near building entries.
- f) *Conceal Loading and Service Areas.* Loading and service areas should be located at the side or rear of buildings, and away from view of public streets. For larger buildings or where heavier loading/truck traffic is anticipated, loading routes should be separated from the regular travel routes used by customer and employee vehicles.

FIGURE 5.X.X – ACCESS AND CIRCULATION

INSERT CURB EXTENTION; Front Entrance Streetscape/Landscape; Shared Curb Cuts, Bike Facilities, Screen Service/Loading Areas

- 5. *Parking.* Parking should be placed convenient to the building entries, but not at the expense of the pedestrian safety, attractiveness, and aesthetics of the property. Parking is necessary to support the function and economic vitality of a development, but it should not be viewed as utilitarian only. Parking should be integrated with other site amenities that support businesses, employees and customers. For specific parking requirements refer to the Parking Regulations in Article 8 of the Zoning Bylaw.
 - a) *Minimize Parking Location and Orientation.* Parking should be located to the rear and side of buildings to reinforce the pedestrian environment. Where a parcel is located at the corner of two streets, parking should be located at the rear or at the internal side (not the street side). Where located to the side of buildings, parking areas should be set back from the street by at least the same distance as the building. Parking should not be placed within the front yard zoning setback. Certain exceptions for teaser parking or private on-street parking may be considered.

- b) Reinforce Parking Access and Streetscape. When parking placement in fronts of buildings is unavoidable, they should reinforce the streetscape with street trees, landscape beds, low fences or stone walls, and other techniques to soften the parking area.
- c) Integrate Parking Landscape. Large parking areas should be broken into smaller areas by means of landscaped islands containing low plantings and trees. Such islands should be placed at regular intervals across the parking lot to reduce the visual impact of the parking area and to reinforce a more pleasant pedestrian environment. Landscape islands should also be integrated with pedestrian circulation and crossing routes through parking areas.
- d) Provide Pedestrian Access. Provide dedicated walkways within the parking area leading to building entrances, and between the public sidewalks and building entrances for safe and convenient access for pedestrians.

FIGURE 5.X.X – PARKING PLACEMENT AND DESIGN

Placement, teaser, private on street, internal access

- 6. Landscape. Parcels should include a hierarchy of landscape that contributes to the overall site design and integrates with adjacent properties. The hierarchy should include entry and gateway landscape, building and building entry landscape, street landscape, site feature landscape and landscape buffers. Refer to the required list of species in the Site Plan Rules and Regulations that are drought tolerant, native to New England and non-invasive.
 - a) Define Entry and Gateway Landscape. Entry and gateway landscape should be used to define site access and reinforce a sense of arrival and layout of circulation on the site.
 - b) Integrate General Site Landscape. The layout of primary or secondary vehicular or pedestrian circulation should be reinforced with a consistent landscape treatment that contributes to site wayfinding. All portions of a site will not or should not be landscaped, but the landscape should be used to reinforce the character, circulation and features of the site.
 - c) Coordinate Scale of Landscape. Selection of plantings and maturity of plantings should be carefully considered relative to the overall scale of development. The scale of the installed landscape should be directly tied to the overall scale of the development and buildings. New plantings should be selected for reasonable maturity at the time of installation to achieve the intended buffering and effect immediately.

- d) *Define Building Landscape*. Building landscape should be used to integrate the buildings into the overall site plan, soften building edges, and enhance public sidewalks, building entries, and plaza areas. Foundation plantings, planter beds, window planters, and sidewalk street trees and shrubs are all appropriate for this purpose. Landscape may be used to mitigate or screen less desirable components or features of a building façade.
- e) *Highlight Feature Landscape*. The landscape should be used to reinforce the importance of locations that are significant in the overall site design or near natural site features or amenities. Incorporating rock outcroppings found on site into landscape treatments is one example of a landscape feature. An additional number of plantings, unique composition or variation in planting species, or plant species with special seasonal variation should be used to reinforce such site features.
- f) *Provide Landscape Buffers*. Landscape buffers and fencing consistent with architecture and other site features should be used to conceal dumpsters, recycling areas, staging areas, utilities and other outdoor equipment or service uses from pedestrian views.
- g) *Reinforce Landscape Buffers at Property Lines*. Where a commercially-zoned property abuts a residentially-zoned or used property, a variety of landscape buffering elements and screening fencing should be provided along the adjoining yard(s). Landscape buffering should be effective four- seasons and of lushly-planted vegetation averaging four to five feet tall.
- h) *Coordinate Landscape at Street Frontages*. Landscape for the site frontages on public ways should contribute to the character of the street and reinforce a consistent street frontage that is integrated with the character, type and spacing of adjacent landscape improvements.
- i) *Integrate Functional Features and Materials*. The materials used for functional features, such as retaining walls, drainage structures or other required site elements, should be integrated with the overall site design and material palette. For example, a functional retaining wall should include stone facing to match stone walls on the site.
- j) *Integrate Functional Features into Landscape*. Stormwater retention areas should be integrated with the site landscape and treated as a naturalized environment and site feature that is sustainable from a plant material and maintenance perspective. Retaining walls, fencing, guardrails and other utilitarian or screening features should be integrated with the overall landscape design and designed to contribute to the overall site character. Functional site features should be designed and considered for views of them from adjacent properties.

7. Site Amenities. Site amenities should enhance activity and serve a function near site and building entries and serve to enhance the pedestrian experience. Site amenities should include benches, trash and recycling receptacles, bike racks, and other components appropriate to the use and scale of the development.
 - a) Coordinate Location of Amenities. The amenities should be located in high activity areas that are most likely to receive use. For example, places to sit should be provided where people are waiting or congregating as part of the use of the building and site.
 - b) Provide Open Space Amenities. As part of commercial sites over 1 acre, a small but well-designed and inviting open space should be provided, of minimum size 300 square feet. The open space should be located in a prominent location adjacent to the building, and near a primary building entry that will bring pedestrian activity to the space. The open space should include outdoor seating, pedestrian-scaled lighting, and landscape, including both sunny and shady areas. Outdoor seating areas are encouraged.
 - c) Coordinate Design of Amenities. The character and design of the site amenities selected should be consistent with the overall character of the site and building design
 - d) Integrate Amenities. Site amenities should be integrated with the site design to allow appropriate clearances, space and circulation around them to allow busy areas to function appropriately.
8. Site Lighting. Site lighting is intended to provide for pedestrian safety in areas with evening activity, particularly near site and building entries and across parking lots, and to provide a minimum level of lighting for nighttime safety. Lighting design must comply with the lighting requirements of the Zoning Bylaw.
 - a) Minimize Lighting. Site lighting should comply with minimum lighting requirements and standards, but not provide lighting in excess of requirements. Downward-directed, dark-sky compliant lighting is required as per the lighting requirements of the Zoning Bylaw to minimize excess glare and spillage.
 - b) Create Multiple Layers of Site Lighting. Site lighting should perform multiple functions on multiple areas on the site for multiple users. A site lighting approach should be designed for vehicles, pedestrians, building entry areas and site features. Each of these multiple areas should be designed in coordination and to complement the overall character of the site. Lighting should be used to highlight key areas and attractive features of the site design. Lighting heights and poles should be scaled appropriate to the use, pedestrian height lighting and light bollards should be used when not lighting a vehicular area. Light fixtures of varying height should be of a compatible design and cohesive lighting fixture palette.

- c) *Integrate Lighting Fixtures with Design.* Lighting fixtures should be selected to contribute to the overall character of the building and site, consistent with the overall design and sense of place.

DRAFT

5.0 COMMERCIAL, INDUSTRIAL, AND MIXED-USE DEVELOPMENT

5.5 DOWNTOWN DEVELOPMENT STANDARDS

A. Applicability and Intent. The following design guidelines and standards are applicable to new development, redevelopment, rehabilitation, renovations of properties in the Planned Development District (PD). The intent of this section is to facilitate building renovation and development that is compatible with the historic character and settlement patterns of Downtown Winchendon's traditional town center and surrounding neighborhoods. The standards set forth herein are intended to:

- A. Promote development that is consistent with the Town's vision to facilitate reinvestment in downtown and create a vibrant, authentic, diverse, connected, and resilient district.
- B. Guide the physical character of development by providing context-based building and site development standards that reflect scale, design characteristics, and development patterns existing or envisioned for the district.
- C. Create a public realm with high quality streetscape, vibrant outdoor gathering spaces, and development that reinforces walkability and multi-modal access.
- D. Encourage high quality housing choices for a variety of age groups, household types, and income ranges.
- E. Encourage local business development with opportunities for food, entertainment, retail, professional and personal services, education, and cultural and civic venues.

B. Architectural Guidelines. The following guidelines outline the architectural design elements that should be viewed as a baseline for well-designed architecture in Downtown Winchendon.

1. **Building Massing.** Building massing should be designed to reduce the overall perceived scale and provide simple forms that reinforce the characteristics of a traditional New England village and a sense of a human-scaled environment.
 - a) ***Strengthen Prominence of Building Entry.*** Building massing should reinforce the purpose and readability of the building. For example, building massing should emphasize and highlight the location of the primary building entrance.
 - b) ***Visually Reduce Larger Building Scale.*** Large building masses should be broken down through variations in roof lines, bays, setbacks, upper-level setbacks, horizontal or

vertical articulation, or other types of architectural detailing as described in Section 2 - Façade Composition and Components below. Overall building form should be appropriate to the scale of the building and not become overly complicated.

- c) *Simplify Smaller Buildings.* Smaller building masses should remain simple and not overly complicated.
- d) *Reinforce Corners and Gateways.* Sites located at a prominent corner, intersection, or gateway should have building features and orientation that recognize the corner or gateway and respond to it with a suitable building form. Examples of prominent building features include tower or cupola elements, corner detailing, additional building height, entrances, or other building forms that provide a visual anchor.
- e) *Integrate Historic Structures.* Existing historic structures should be integrated into any new development plan. New buildings and additions should complement and reflect the style of existing older structures. Historic buildings should be considered for restoration, sensitive rehabilitation, preservation or adaptive reuse as may be appropriate to the historic structure and nature of its reuse. Refer to the Secretary of the Interior’s Standards for Rehabilitation of historic buildings.
- f) *Integrate Accessibility Features.* Accessibility ramps, lifts or other access requirements should be integrated into the design of the building entry at the building exterior and interior. Accessibility components should be a purposeful part of the building entry design.

FIGURE 5.5.X – BUILDING MASSING		

2. *Façade Composition and Components.* Composition of building façades should include architectural features and building components that reduce the scale of large building masses, reinforce the character of the building to reflect a New England village style, and provide detail and articulation of the overall building, particularly in areas with pedestrian traffic.

- a) *Emphasize Façade Rhythm and Patterns.* A building façade should be broken into vertical and horizontal parts that reinforce a rhythm and pattern. Vertically, a building should be seen to have a base, middle and top. Horizontally, the building should be broken down into sections that correspond to and indicate bays of the structural system.
- b) *Avoid Long and Blank Façades.* Building façades should be differentiated at intervals typically not less than 50 feet or less by a change in material, a variation in the plane of the wall, decorative components, or functional element such as entryway or

portico. Sections of continuous, uninterrupted, or blank building façades typically should not exceed 50 feet.

- c) Emphasize Primary Façade Height. The principal façade should not be less than typically about 20 feet in height with an articulation of the base, middle and top.
- d) Encourage Neutral Building Identity. Building design and architectural features should reflect a New England village character. Franchise businesses should not over-prioritize brand features or identity. Signage, colors, awnings and other design features should be used to communicate brand and franchise identity. The building form, roof form and façade design should not be overly specific to a franchise or brand.
- e) Use Human-scaled Façade Features. Awnings, canopies or other elements that break-down the overall scale of the building façade and provide protection and visual interest at building entries are encouraged. Refer to Sign Regulations in Section 6 and design guidelines for specific sign, material and lighting requirements.
- f) Design Façade for Signage. The façade design and architectural detailing should provide a purposeful place for signage, if signage is intended to be a part of the façade. An extended parapet, entablature, or sign band should be designed and integrated into the façade layout with appropriate spacing for both the height and width of anticipated signage. Refer to Sign Regulations for specific sign, material and lighting requirements.
- g) Integrate Utilitarian Components into the Façade Design. All functional, utilitarian, or mechanical components of the building façade should be integrated into the façade or screened so as to be part of the composition of the overall building design. Mechanical vents, service rooms, utilitarian and staging areas, and similar portions of buildings should be hidden to match other materials and colors of the façade. Utilitarian aspects should also be screened by the site and building landscape.

FIGURE 5.5.X – FACADES		

3. Building Roof Forms. Building roof form has a significant impact on the character and style of the architecture. Building roof forms should be both authentic to the type of building they are part of and strive to reinforce a sense of New England village character and scale.
 - a) Reinforce New England Village Character. Traditional steeply-pitched roof forms are encouraged in order to reinforce a New England sense of place and assist in managing snow loads. Roof slopes should be in the range of 8:12 to 12:12 (vertical: horizontal). Roof styles may include gable, hip, half-hip, gambrel, saltbox, and shed. Flat roof are

appropriate for multi-floor and mixed use downtown buildings, or tall one-story buildings with a front façade height of at least 16 feet.

- b) Reinforce a Human-scale to Buildings. Large uninterrupted roof forms should be avoided and articulated with roof gables, dormers, chimneys or other roof forms that provide variety and interest to the overall building form.
- c) Integrate and Screen Utilities. Mechanical equipment on rooftops should be screened from visibility of pedestrians standing at grade on surrounding walkways by means of walls, decorative grilles, or roof parapets. Screening features should be a part of the building composition and design and use materials that complement the overall roof and façade design. Other utilities, such as solar panels should be integrated into the design of the roof.

FIGURE 5.5.X – ROOFS		

- 4. Building Lighting. Building lighting should be used to highlight and emphasize functional and decorative aspects of the building massing and facades. Building lighting should be energy efficient and designed to be minimized and focused on key components of the building. Lighting design must comply with the lighting requirements in **Section XX** of the Zoning Bylaw.
 - a) Define Hierarchy of Lighting. Building entries should be a primary focus of building lighting to reinforce safety, security and convenience for access to the building. Lighting to highlight building features, key architectural elements, accents, or signage should be a secondary focus of building lighting.
 - b) Minimize Quantity of Lighting. Illumination levels should be provided at the minimum level that is required to provide the function desired.
 - c) Coordinate Light Fixture Design. Lighting fixtures should be selected to contribute to the overall character of the building and site consistent with the overall design and sense of place.

FIGURE 5.5.X – BUILDING LIGHTING		

C. Sign Guidelines. The sign guidelines for Downtown Winchendon provide guidance for functional and attractive signs in this pedestrian-oriented district. Sign design must comply with the dimensional, usage, placement, and other regulations contained in the Sign

Regulations in Article 9 of the Zoning Bylaw. The guidelines focus on well- designed signage in the context of compliance with applicable regulations.

1. Principles and Intentions. Signage for commercial uses or businesses should communicate a positive and clear identity for the establishment, be part of the building and façade design, harmonize with its surroundings, and respect Downtown Winchendon’s New England village character.
 - a) Reinforce New England Village Character. Sign design should be appropriate to traditional New England village character, including use of historic, muted colors; traditional-style sign face materials such as wood or wood composite; and lettering that is painted, gold foil stamped, carved dimensionally, vinyl cut, sand-blasted or etched, or metal channel- cut.
 - b) Emphasize Legibility and Clarity. A sign should be readable, simple, and legible with careful consideration of the proportion of lettered and graphic areas to the overall size and location of the sign. Consideration should be given to the purpose and intended audience of the sign, **whether vehicular or pedestrian**. Signage should be concise and graphically balanced.
 - c) Define Hierarchy of Signage and Purposes. The most important sign should be most prominent on the site. The most important information on a sign should be the most prominent and emphasized component of the sign. Sign design should optimize communication of the name of the business.
2. Sign Harmony.
 - a) Reinforce Compatibility with Context. Signs should be designed to be compatible with neighboring properties, storefronts, and buildings. Compatibility should be considered through sign style, height, type, scale, and location.
 - b) Reinforce Compatibility with Residential Context. Where business uses are interspersed with residential uses, signs should be designed and located with sensitivity to nearby residential areas. Illumination should be designed to minimize impact on adjacent residences.
 - c) Coordinate Compatibility with Building Architecture. Sign design and placement should relate to and harmonize with the building architecture. Signs should not overwhelm or obscure building features.
 - d) Complement Other Signs. Where a business or development has more than one sign, all signs should be designed to be compatible in terms of materials, color, lettering, style, and logo use. Design and placement of multiple signs should reflect a clear hierarchy and coordinated overall visual effect.

FIGURE 5.5.X – SIGN HARMONY

3. Sign Characteristics.

- a) *Focus Signage Design and Readability.* A sign should be readable, simple, and legible, with sign content that fits comfortably within the space it will occupy on the building. Generally, a sign's text and graphic elements should not occupy more than two-thirds of the sign panel area.
- b) *Emphasize Signage Legibility.* Signage typeface should also be simple and legible; ornate or unusual typefaces should be used only for emphasis and restricted to single words or short phrases. The use of both upper and lower case letters reinforces sign legibility.
- c) *Consider Signage Scale.* Signs should be scaled to their use and intended viewer, be that the driving or walking public. Sign lettering and graphics should be clear, simple, and legible from a distance, under different lighting conditions. Scale of sign should be appropriate for its intended audience and its location on a building or site. **For automobile-oriented signs, signs should be legible at posted driving limits.**
- d) *Focus Signage Content.* Signage messaging should be simple and brief to maximize a sign's visibility and clarity. Signage should primarily communicate the name of the business or establishment through lettering, graphics or logos. In order to reinforce signage purpose, the following information should not be included on a primary sign: telephone numbers, business hours, website address, sale information, listing of goods and services, brand names carried, or credit cards accepted.
- e) *Use Signage Color.* Signage color should complement building materials and color palette. Signage color should also consider signage legibility and readability from a distance during the day and night. High contrast between signage lettering and backgrounds helps increase legibility. Lighter colored lettering on darker backgrounds is recommended.
- f) *Coordinate Signage Materials.* Signage materials should be selected for durability, ease of maintenance, and compatibility with building materials and design.

4. Site Signage. Site signage includes any sign that is not attached to a building, but is part of the site design and layout to assist in the identification of the development, businesses, or wayfinding on the site.

- a) *Integrate Signage Design with Landscape.* Site signage should be integrated with site landscape design and be used to reinforce gateway locations and site entry points.

Landscape plantings should be included to anchor and integrate signage into the site plan. Refer to Sign Regulations in Article 9 of the Zoning Bylaw.

- b) Coordinate Signage Placement. Sign locations should consider lot characteristics in regard to roadway and access considerations, building location, views in and out of the property, pedestrian and vehicular circulation and vehicular safety and visibility. Refer to Sign Regulations in the Zoning Bylaw.
- c) Coordinate Signage Style. Free-standing signage should complement the overall character and design of other site and building components. Free-standing signage should be balanced and proportional. Incorporate elements of the building design into a free-standing sign design.
- d) Define Multiple Tenant Directory Signage. For multi-tenant developments, an internal site directory sign may be provided listing names of businesses and establishments. Directory signage should be clear and legible with the ability to conveniently change business names as tenants move in and out. Design of the sign should be consistent with other development signage.
- e) Coordinate Wayfinding Signage. Simple directional signage may be provided on the site to inform visitors of entries, parking areas, building names, numbers, or other information. Wayfinding signage should be consistent and compatible with other development signage. Wayfinding signage should not obstruct or cause conflict with regulatory or traffic-related signage.

FIGURE 5.5.X – SIGN CHARACTERISTICS		

- 5. Building Signage. Building signage includes any sign that is attached to a building to provide identification of businesses.
 - a) Integrate Signage Design with Building. Signs should integrate with the building on which they are placed, by considering the architectural style, character, or historic significance, rhythm and scale of façade features, and patterns of window and door openings. Particularly with older buildings, care should be taken not to obscure, damage or otherwise interfere with design details and architectural features that contribute to the building’s character.
 - b) Coordinate Sign Placement. Signs should be designed for the specific building on which they will be placed, and for the specific location on the building. Signs should generally be centered within the wall area of the façade on which they will be located. Signs should not extend beyond the boundaries of the area of the building on which it will be mounted. Signs previously installed on other buildings or locations should not be used.

- c) Define Multiple Tenant Building Signage. Multiple tenant or business signs on a building should have a consistent placement and be of a coordinated design. Using signage to reinforce or establish a rhythm, scale and proportion for a building is encouraged, especially where such elements are weak or absent in the building’s architecture. A Master Signage Plan should be developed for multi-tenant developments to encourage a coordinated and compatible approach to signage according to the Sign Regulations.
- d) Coordinate Secondary Signage. Window and door signage should be coordinated with the overall signage program and may include more detailed information that is not appropriate for larger signs. Window signage is generally directed toward the pedestrian viewer. Window signage should not dominate the glazed surface. Window signage and displays should not include the stockpiling of products or inventory inside the windows.
- e) Design Awning Signage. Awning fabric should be opaque, and any awning signage should use cut or screen-printed letters or logos. Lettering and graphic elements should comprise no more than 30 percent of the total awning surface.
- f) Integrate Sign Mounting. Projecting signage should be integrated into the design of the façade with attractive sign mounting hardware.
- g) Complete Sign Location Preparation. The areas of the building to receive the sign should be prepared, cleaned and painted prior to installation of the sign. Previously installed signs should be completely removed and any remnants or wall surface damage repaired and covered prior to the installation of a new sign.

FIGURE 5.5.X – BUILDING SIGNS		

- 6. Sign Illumination. External signage illumination is encouraged and should be targeted only onto the sign, not onto adjacent buildings or towards vehicles or pedestrians.
 - a) Focus Awning Sign Illumination. If a window awning sign is internally illuminated, only the sign letters, logo and ornamentation should be translucent. The background material should be opaque.
 - b) Limit Internal Sign Lighting. The preferred forms of internally lit signs are those using push-through graphics and text; standard channel letters, also called back-lit or halo-lit; and reverse channel letters with a halo effect. When signs other than channel letters are internally lit, only the sign copy (words/logo) should be illuminated. The sign background or field should be opaque and of a non-reflective material. Internally illuminated box cabinet signs are discouraged.

- c) Integrate Lighting Utilities. Raceways, conduits and other electrical components should be concealed from public view. When it is not possible to conceal, such utilitarian components should be painted to match the background of the wall on which they are mounted to reduce the visual impact.
- d) Coordinate Signage Lighting Fixtures. External lighting fixtures that project the light from above the sign are strongly encouraged. Light fixtures should be simple and unobtrusive, and should not obscure the sign’s message and graphics.
- e) Provide Consistent Lighting Levels. Lighting should provide a consistent and even wash of light across the sign.

FIGURE 5.X.X – SIGN ILLUMINATION

D. Pedestrian Frontage Zones.

1. Purpose and Intent. The Pedestrian Frontage Zones (PFZ) applies to properties along designated downtown streets prioritized for pedestrian-oriented commercial uses on the ground floor and commercial and residential uses on the upper floors. PFZ streets include **Central Street and portions of Front Street and Spring Street** as illustrated on the map below.

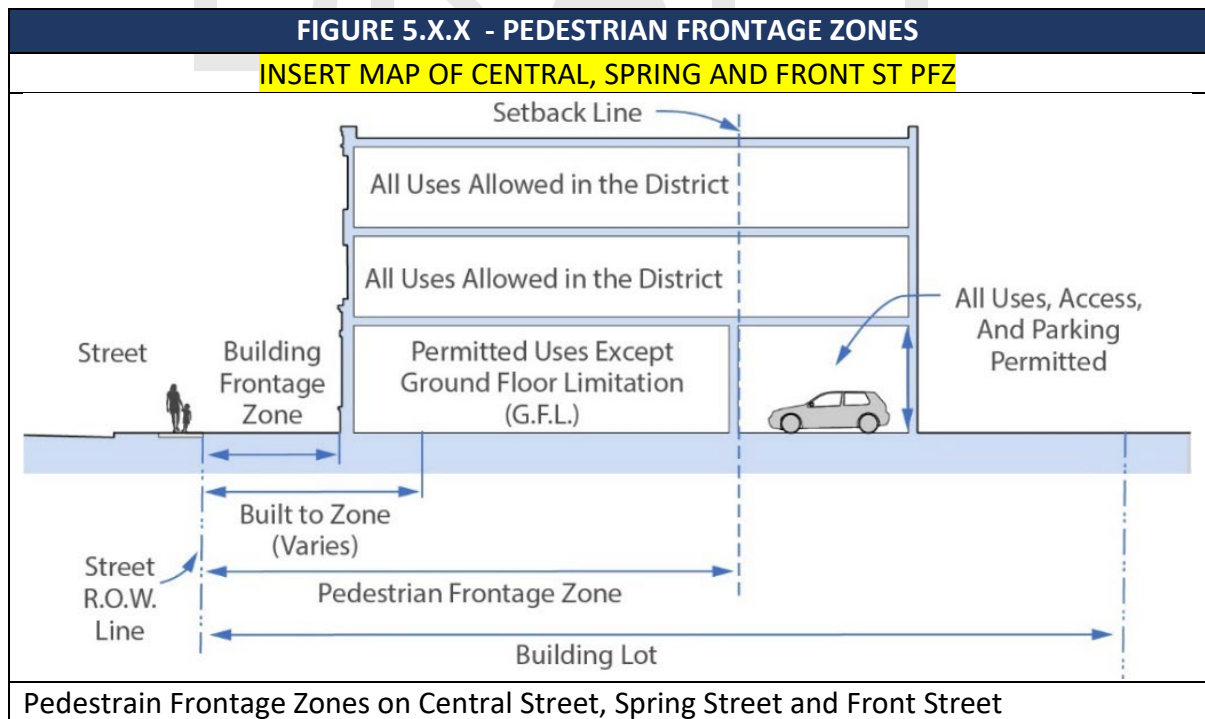

2. Uses. Buildings fronting on the designated street segments for Pedestrian Frontage Zones should abide by the following guidelines:

- a) Ground floor uses should be reserved for retail, restaurant, and publicly-oriented uses including but not limited to personal service, office, and civic uses.
- b) Residential uses and non-residential uses not oriented to public access should have access from the building frontage zone by an entrance that leads to the upper floors of the building or the rear of the building.
- c) Residential uses and commercial uses not oriented to public access should be located above the ground floor where:
 - 1) The use is within a building with frontage on the street and the use is set back a minimum of 60 feet from the street right of way (R.O.W.) line; or
 - 2) The PEDB may waive this requirement if it determines that street-front residential and/or other non-publicly oriented uses will not have an adverse impact on the continuity and vitality of the publicly-oriented street-front uses.

E. Building Placement and Orientation. Buildings located on streets designated as Pedestrian Frontage Zones in the Planned Development district are subject to the general design guidelines of this section.

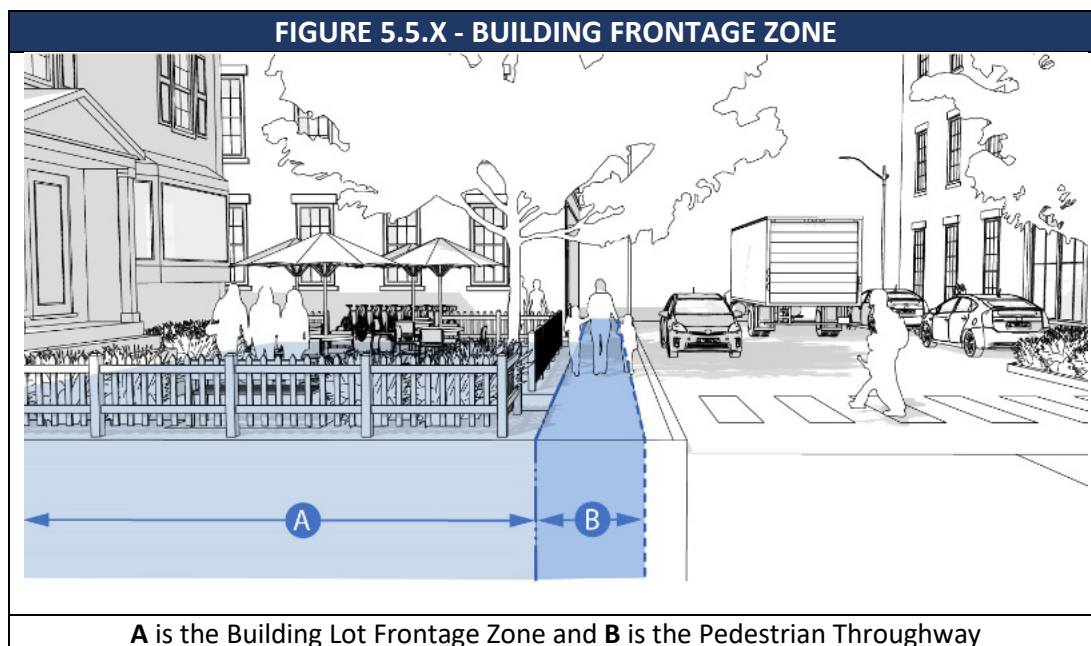

1. **Building Placement.** The building should be located close to or at the Street ROW Line to create a strong connection to the sidewalk and pedestrians.

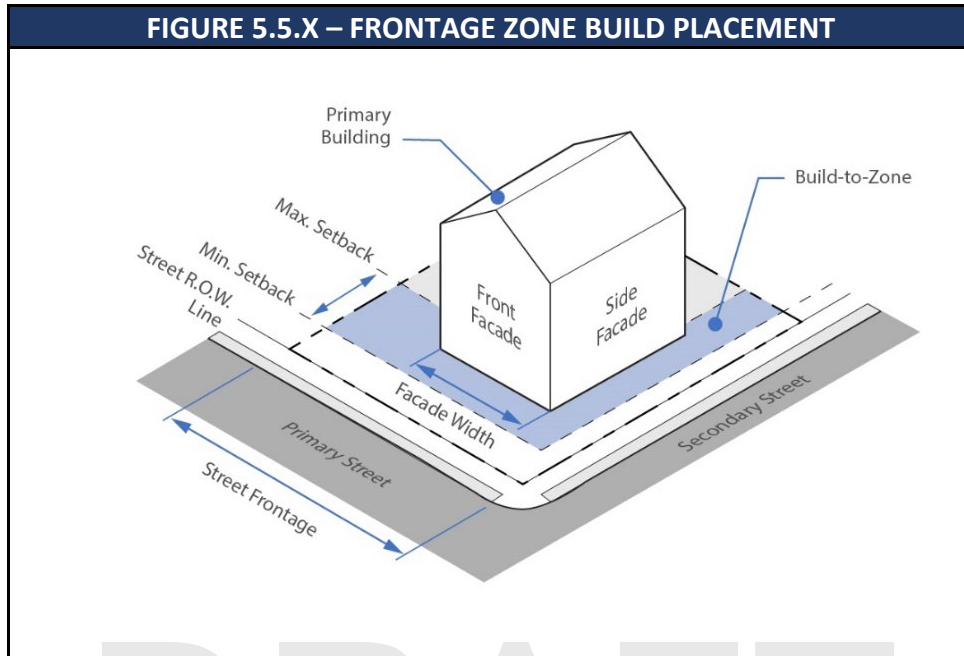

2. **Frontage Occupancy.** The width of the infill building façade facing the Primary Street measured as a percentage of the street frontage shall determine the percentage occupancy of the frontage zone. Primary building frontage occupancy should be equal to at least 30% of the street frontage width at the street row line unless otherwise specified.

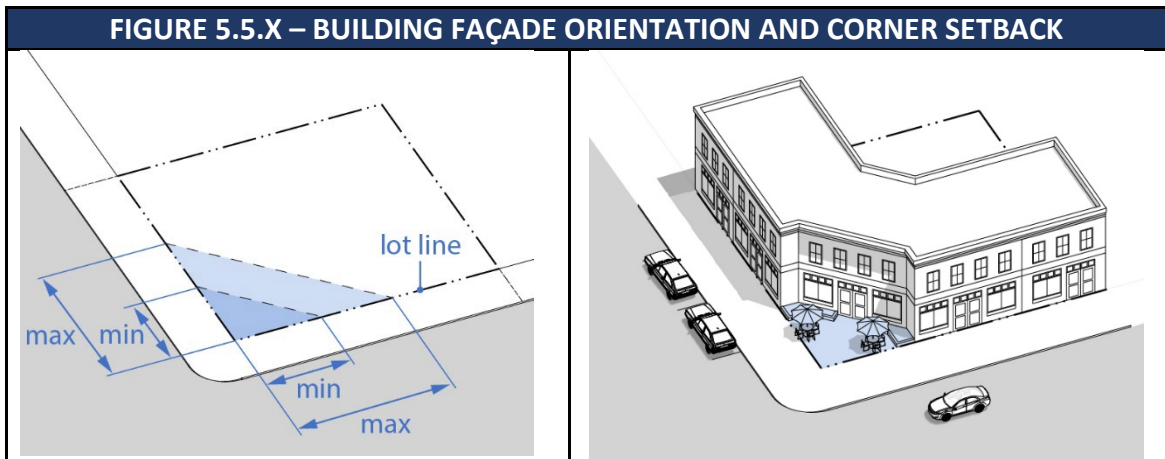

3. **Orientation.** The front façade and entrance of a principal building should be built parallel to a street row line. On a corner lot, the building façade may be retracted to allow for Outdoor Amenity Space.

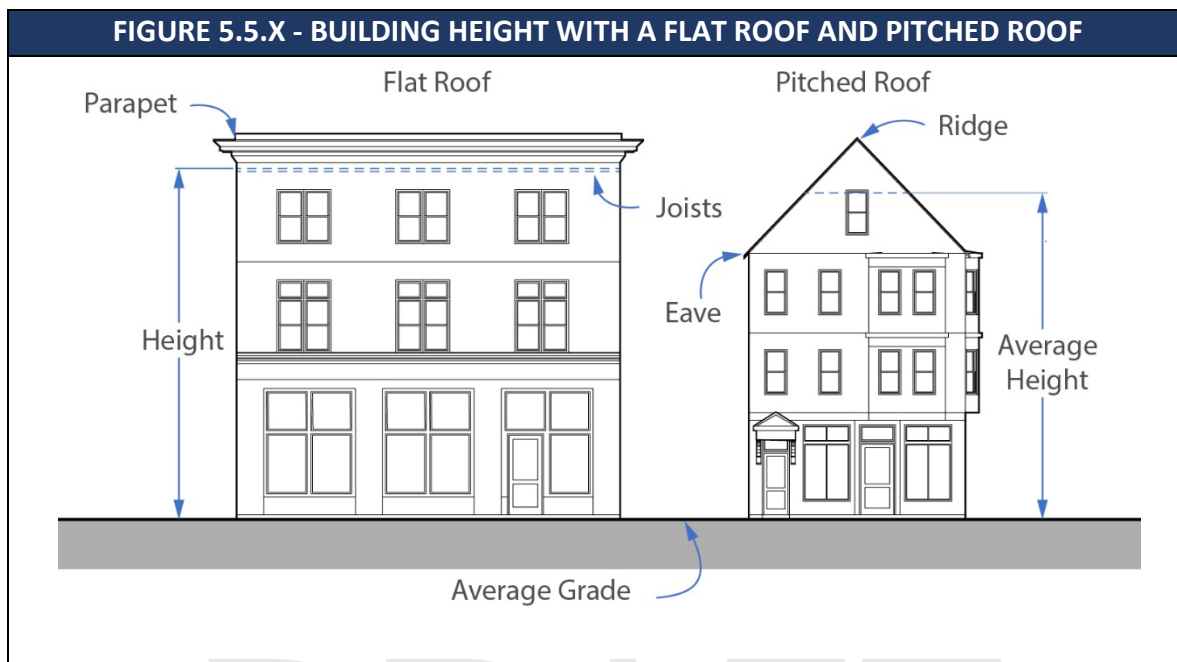

4. **Half-Stories.** When building height allows for a half-story, the half story is counted as the habitable space located directly under a pitched roof. For half-stories, the following standards apply:
 - a) The roof rafters should intersect the wall plate or top of wall frame of the exterior walls at a height no more than two (2) feet above the finished floor of the half-story.
 - b) Ceiling height of a half story should not exceed twelve (12) feet in height at any point.
5. **Attics.** Non-habitable attic space located under a pitched roof is not counted as a half-story.
6. **Building Height Exceptions.** Height limits do not apply to Outdoor Amenity Spaces such as a roof deck, terrace, garden, trellises, and related structures conforming to Section 7. Height limits do not apply to mechanical and stairwell housing; roof mounted cellular, radio, and internet transmission equipment; vents or exhausts; solar panels or small wind turbines; skylights; flagpoles; and belfries, chimneys, cupolas, monuments, parapets, spires, steeples, and other non-habitable architectural features.
7. **Building Stepback and Street Enclosure.** Buildings should be set back or stepped back from the street right-of-way line in accordance with Figure XX below. The purpose of this guideline is to enhance the pedestrian environment and prevent excessive street enclosure and shadowing on the street. Within the spaces created by building setbacks or stepbacks, Outdoor Amenities Space is encouraged.

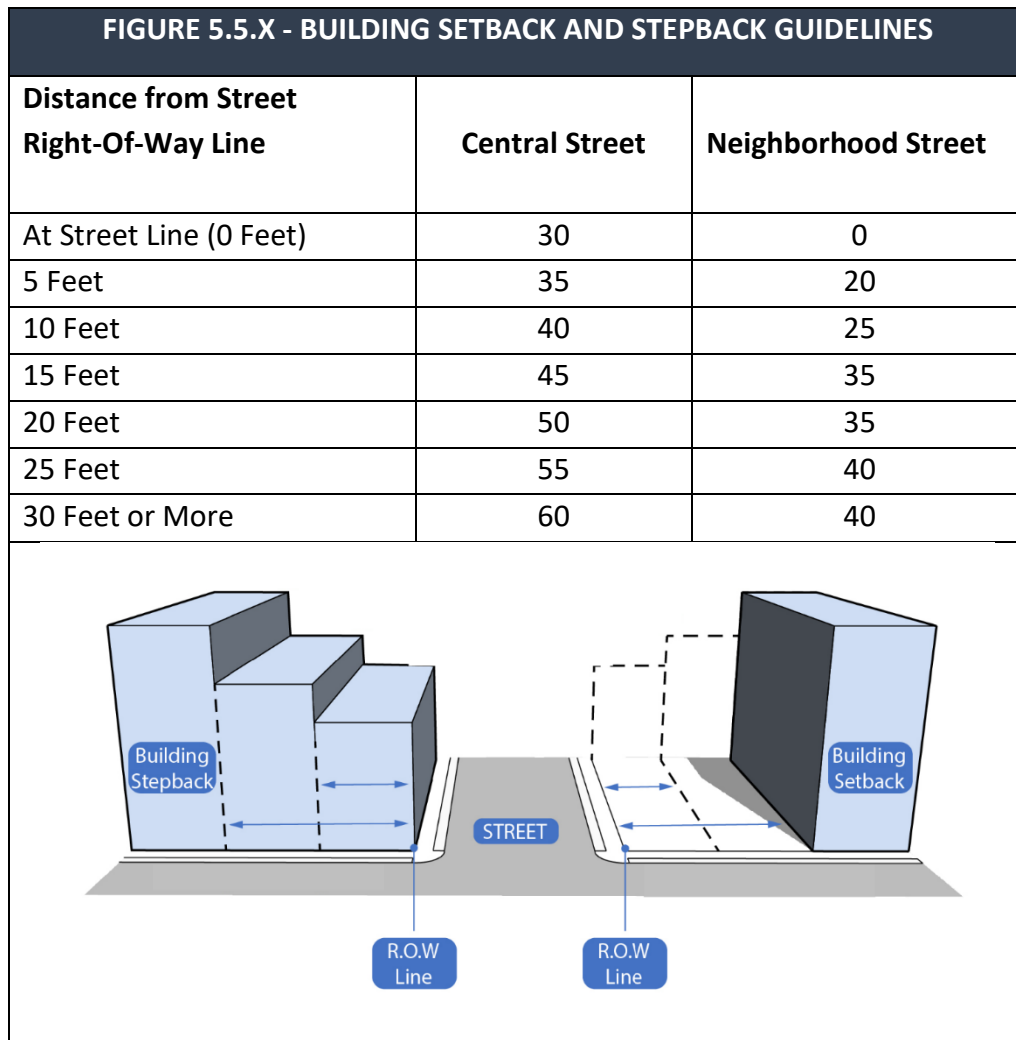

F. Roof Types and Design.

- Roof Shapes and Pitch. The shape and proportion of the roof shall be consistent with the following standards:

FIGURE 5.5.X . - ROOF FORMS

Roof Shape and Pitch Requirement

Shed	Hip	Gable	Gambrel	Flat
2:12 Min.	3:12 Min.	6:12 Min./ 12:12 Max.	6:12 Min./ 30:12 Max.	Not Applicable

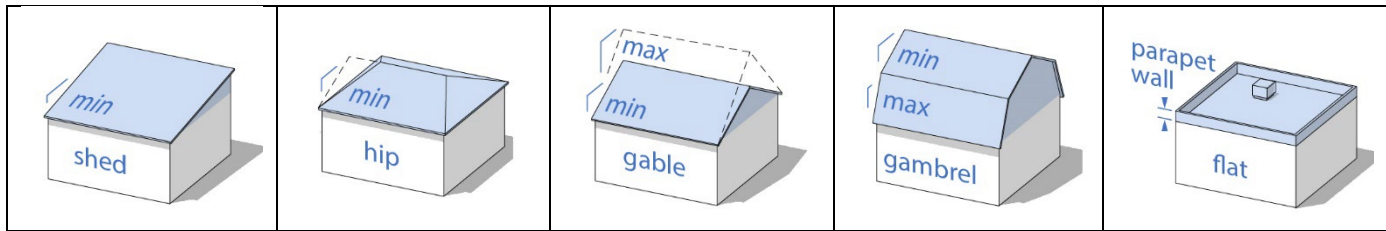

2. **Parapet Wall.** Buildings with flat roofs shall be capped by an articulated parapet that is visible from all sides of the building and screens the rooftop mechanical infrastructure from view at ground level.
3. **Façade Modulation and Articulation.** Street-facing building façades should be horizontally articulated with a clearly defined base, middle, and top as illustrated below. For buildings three stories and taller, the following guidelines apply:
 - a) The top story of each street-facing façade should have a cornice, parapet, roof element, or change in massing as an expression of the building’s top.
 - b) Materials appearing heavier in weight should be used for the buildings base, with materials appearing similar or lighter in weight used above.

FIGURE 5.5.1 - FACADE MODULATION AND ARTICULATION

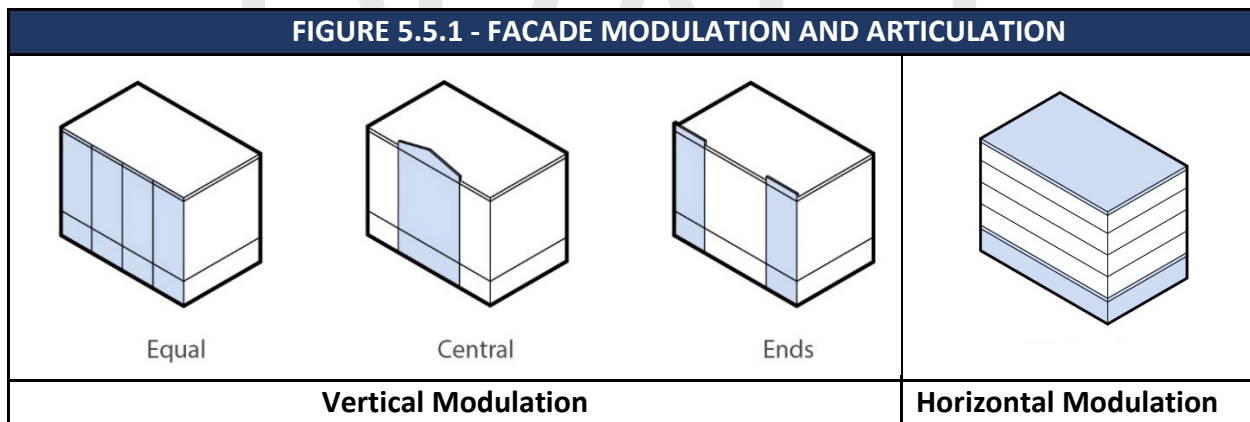

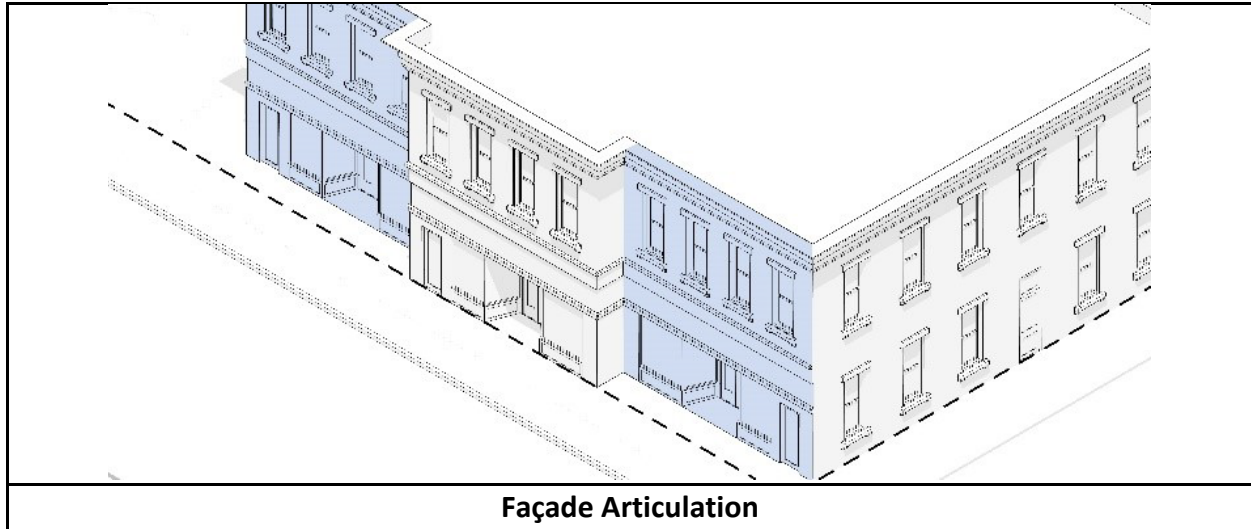

4. Surface Relief with Architectural Features. Street-facing building façades should provide surface relief through the use of bay windows, cladding, columns, corner boards, cornices, door surrounds, moldings, piers, pilasters, sills, sign bands, windows, and other equivalent architectural features that either recess or project from the average plane of the façade by at least four (4) inches.

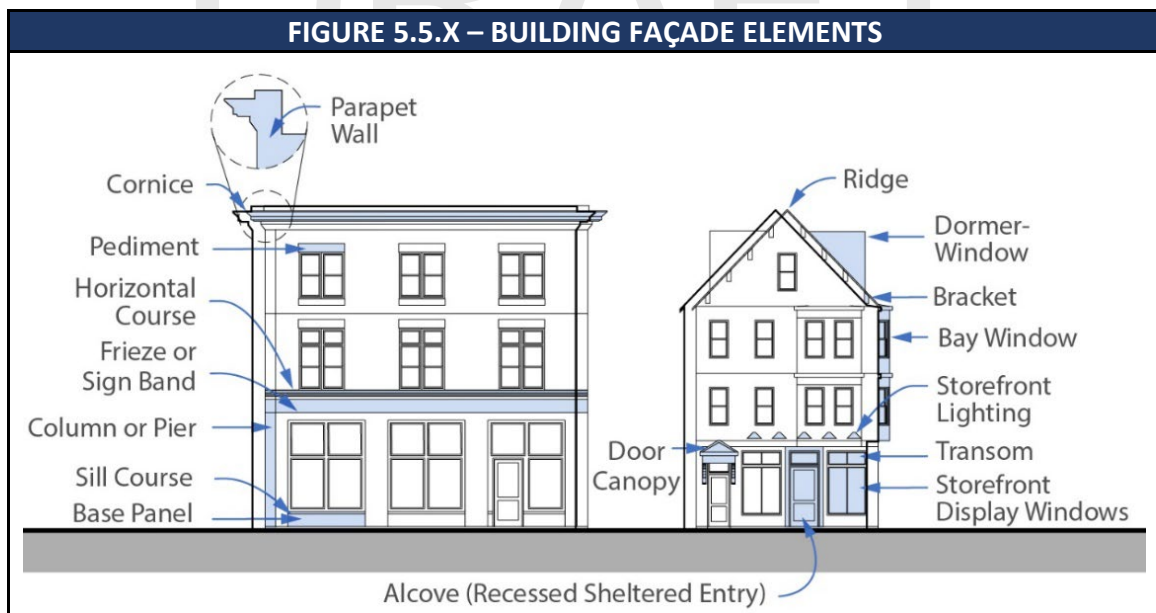

5. Building Transparency. The following guidelines apply to all commercial and mixed-use buildings in Planned Development Zoning District:
 - a) Façades should have windows and doors with highly transparent, low reflectivity glass for a percentage of the total area of a façade, measured for each story independently.

- b) Façade transparency of a ground story façade is measured between 2 feet (A) and 12 feet (B).
- c) Façade transparency requirements are only applicable to façades facing primary and secondary street line.

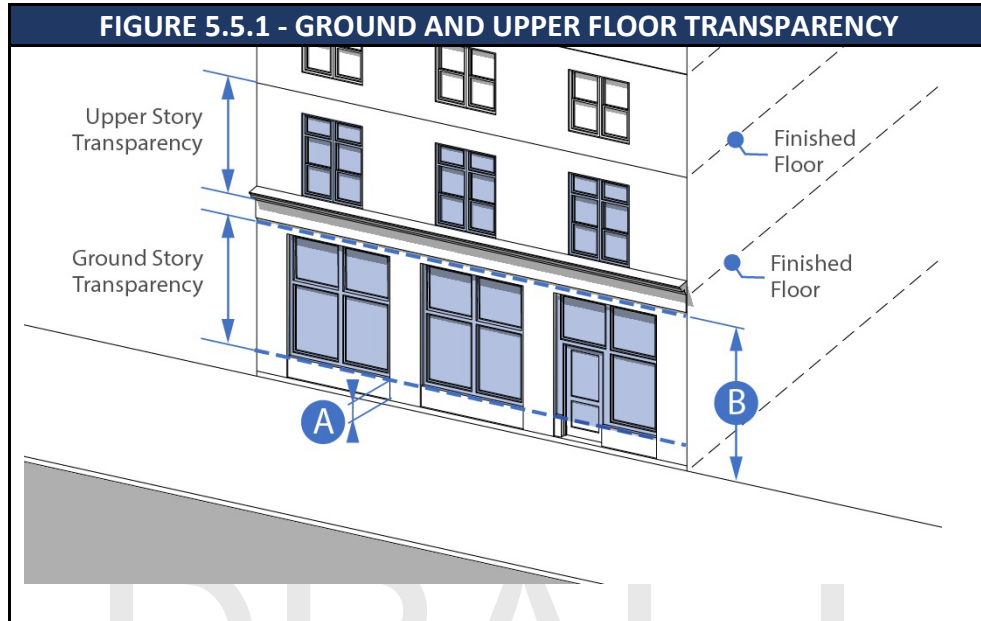

G. Downtown Commercial and Mixed Use Building Types.

The typical building types in the Planned Development District are identified in **Figure 5.X.X** below, supersede uses identified on the Table of Use Regulations in Section 420, and subject to the development standards for each VCN district in Section 580.9.

FIGURE 5.5.X – COMMERCIAL AND MIXED USE BUILDING TYPES IN DOWNTOWN	
1. Live/Work Building	A small floor plate attached residential building type with one (1) dwelling unit and one (1) ground floor commercial unit. Live/Work units are occupied by the owner of the building and the commercial operation.
2. Mixed Use Building	

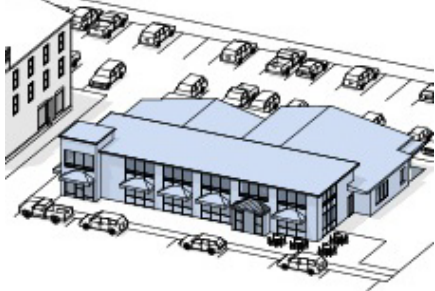
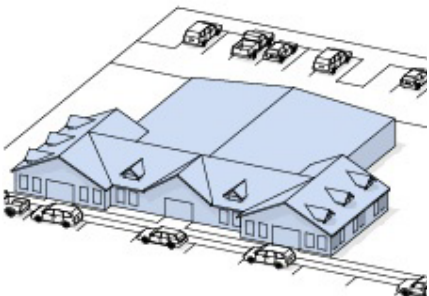
	
<p>3. General Commercial Building</p>	<p>A variable floor plate building type that typically accommodates a variety of ground floor commercial uses and upper office uses at the scale that is compatible and compliments to its given district. GC Buildings are not intended for residential uses.</p>
	<p>4. Gas Backwards Building</p>
<p>5. Flex Space/Fabrication Building</p>	<p>A building located and designed to accommodate a small to medium footprint for fabrication and light industrial uses. Flex buildings are also used to provide affordable space to small and creative business enterprises. There is no minimum lot size or frontage requirement.</p>
	<p>6. Civic and Community Building</p>

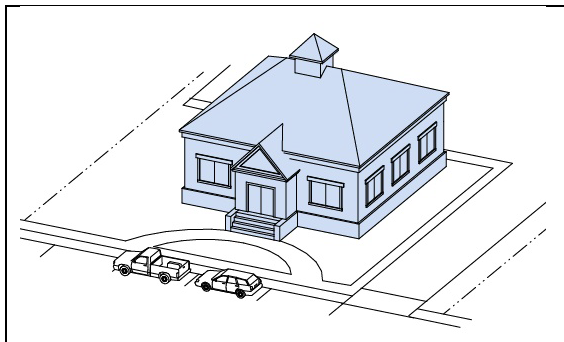
	<p>A building located and designed to accommodate public or civic uses such as a neighborhood center and similar public gathering facilities and spaces. Community Buildings may be privately owned and operated as an accessory building and amenity for a residential and mixed use developments. There is no minimum lot size or frontage requirement.</p>
<p>7. Other Principal Building Types</p>	<p>Planning Board Determination and Review</p>

H. Building Frontage Types and Design Standards.

1. Edge Building. A building frontage type where the building facade is aligned close to or at the street row line with individual at-grade entries for ground level uses provided directly onto a continuous paved surface that runs along the front façade and abuts a paved public frontage zone or pedestrian thoroughway. The area between the façade and streetline can also be utilized as a bioswale to capture and treat stormwater. This type is commonly associated with retail, service, mixed use or hospitality uses.

FIGURE 5.5.1 - EDGE BUILDING FRONTAGE DESIGN GUIDELINES

		
(1)	Depth (Max)	6 Feet
(2)	Length (Min)	Equal to length of the adjacent façade
(3)	Height, Clearance (Min)	10 feet
(4)	To the extent there is a front yard it should be paved to match the adjacent Pedestrian Thoroughway or Public Frontage Zone.	

2. **Forecourt.** A building frontage type where a portion of the building facade is aligned close to or at the street row line, and the central portion of the façade is set back to create a courtyard. The courtyard contains a principal entrance at-grade and space for gathering and circulation, or for outdoor shopping or restaurant seating. The front yard and courtyard may be planted or paved to join with the adjoining public sidewalk. Forecourts are also a permitted Outdoor Amenity Space under Section 7.

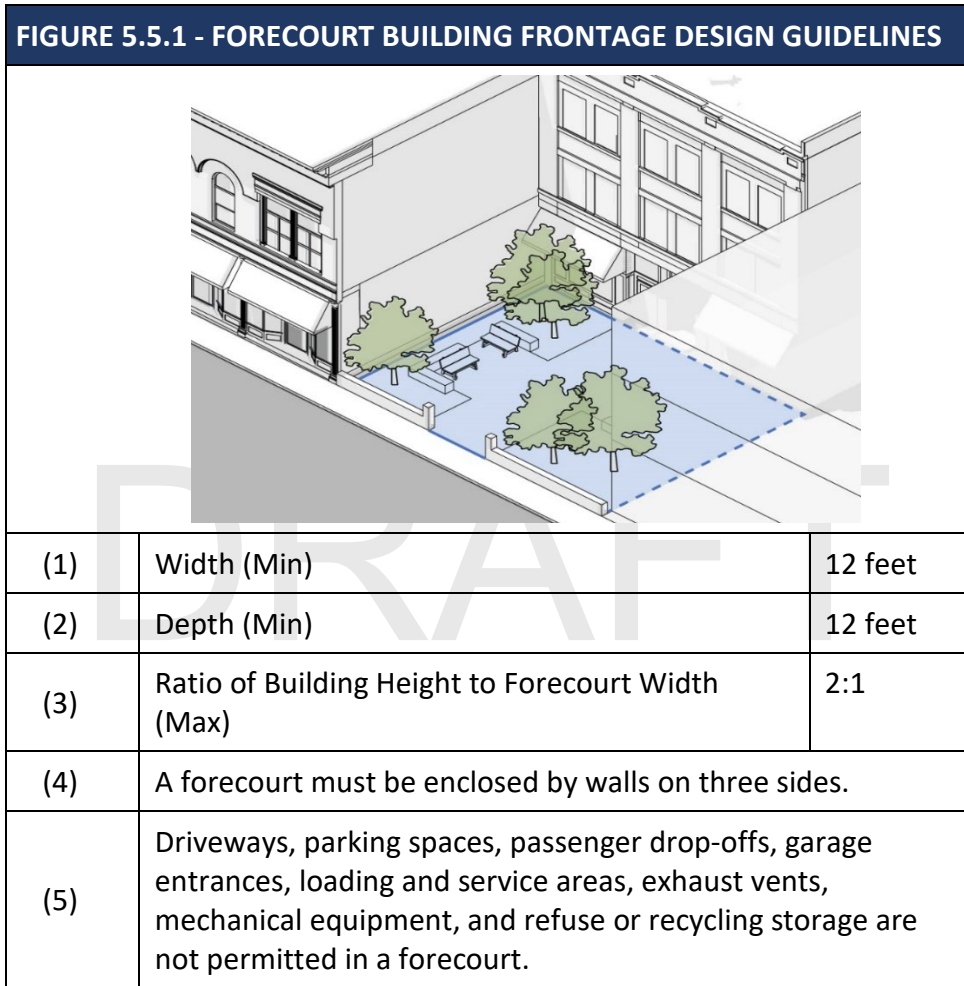

3. **Arcade.** A building frontage type where only the ground floor level of the building facade is set back from the Street Line. The building facade for the upper floors is at the Street Line and is supported by a colonnade with habitable space above. This frontage type is intended for buildings with ground floor commercial, hospitality or retail uses.

FIGURE 5.5.1. - ARCADE BUILDING FRONTAGE DESIGN GUIDELINES

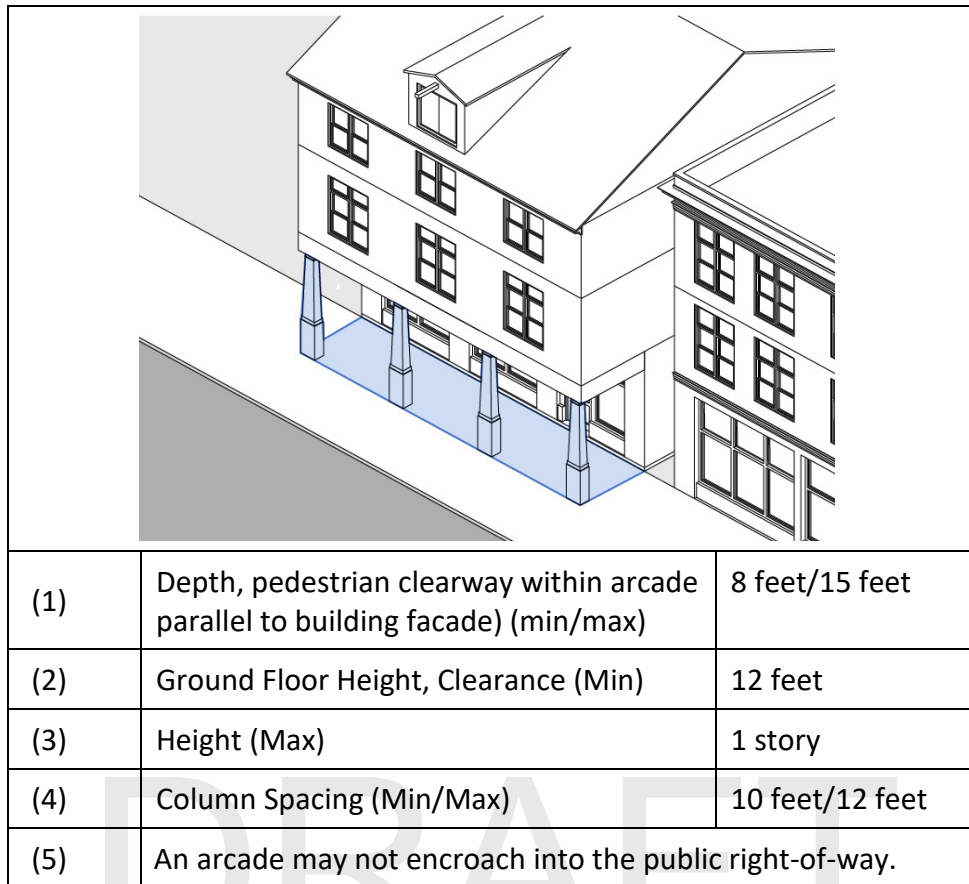

4. **Gallery.** A frontage type where the building façade is set back from the street line with an attached one or two story cantilevered shed or a lightweight colonnade that is built to the Street Line. This type is intended for buildings with ground floor commercial, hospitality or retail uses.

FIGURE 5.5.1 - GALLERY BUILDING FRONTAGE DESIGN GUIDELINES



(1)	Depth (Min)	8 feet
(2)	Width (Min)	Equal to the width of the façade bay to which it is attached.
(3)	Ground Floor Height, Clearance (Min)	8 feet or the first floor height
(4)	Upper deck railing height as applicable (max)	48 inches
(5)	No external stairway is allowed to reach the upper-story portion of a Gallery along a frontage.	
(6)	A Gallery must be open on three sides and may have a roof or awning covering the upper floor.	
(7)	An arcade may not encroach into the public right-of-way without approval by the Board of Selectmen.	

5. Front Plaza and Seating Terrace. A front plaza is a semi-public or public space that occupies some, or all, of the Building Frontage Zone. A front plaza must be at grade with the adjacent Public Frontage Zone, or Pedestrian Throughway. A front plaza is a flexible space intended for circulation, passive recreation, civic uses, or commercial activities. A front plaza is typically primarily surfaced with hardscape and may include public seating and outdoor café seating.

FIGURE 5.5.1 - FRONT PLAZA AND SEATING TERRACE DESIGN GUIDELINES



(1)	Depth (Min)	5 feet
(2)	Length (Min/Max)	8 feet/150 feet
(3)	Distance along frontage between access points (stairs or ramps)	Equal to maximum distance between principal entries
(4)	Height, Clearance (Min)	8 feet
(5)	Clear path of travel (Min)	4 feet for all uses
(6)	Height of walls or fences (Max)	18 inches
(7)	Area (Max)	10,000 sq. ft.
(8)	A front plaza must be generally rectilinear in shape (rectangular or square).	
(9)	A front plaza may be used for pedestrian circulation, public seating, outdoor café seating, outdoor display space, landmarks or public art, bicycle parking, or a garden.	
(10)	A front plaza must provide access to the principal entrance of a building.	
(11)	At least 20% of the front edge of a front plaza should be directly connected to, and at grade with, the adjacent pedestrian thoroughway or public frontage zone.	
(12)	A front plaza should provide a minimum of 1 linear feet of public seating for each 50 square feet of area. At least 50% of this seating must have seat backs.	

I. Ground Floor Facade Types and Design Guidelines.

1. **Storefront.** A façade type where the building facade is aligned close to or at the street row line with at-grade entries for each ground level use. This type is commonly associated with retail, service, mixed use, or hospitality uses, and has substantial glazing and may include an awning or canopy that may encroach into the Public Frontage Zone or Pedestrian Throughway Zone.

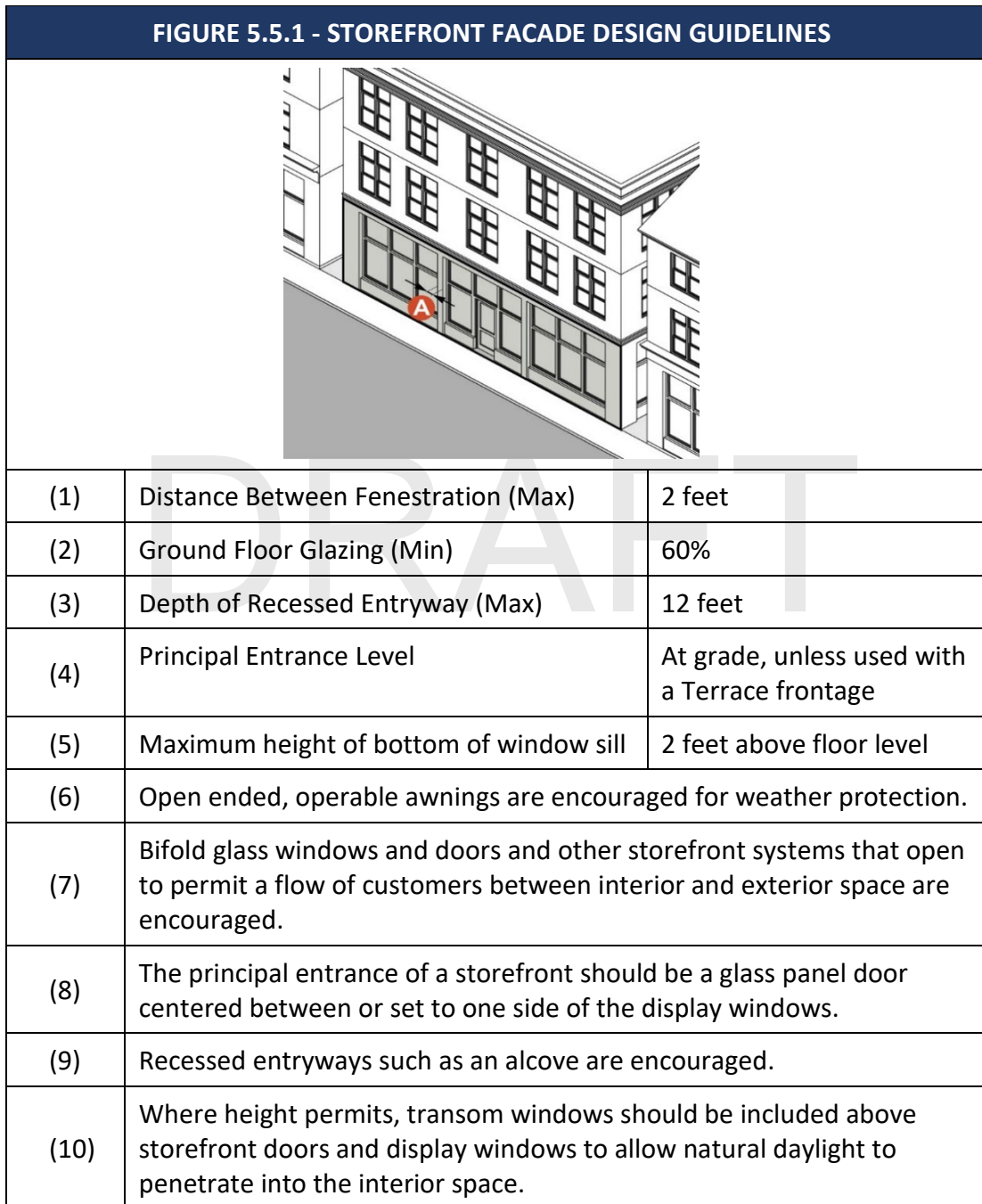

2. **Officefront.** A façade type where the building facade is set back from the street row line with an individual at-grade entry for each ground level use. This type is commonly associated with office, retail, service, mixed use, or hospitality uses. An officefront has substantial glazing on the sidewalk level, although not as much as is typical of a Storefront.

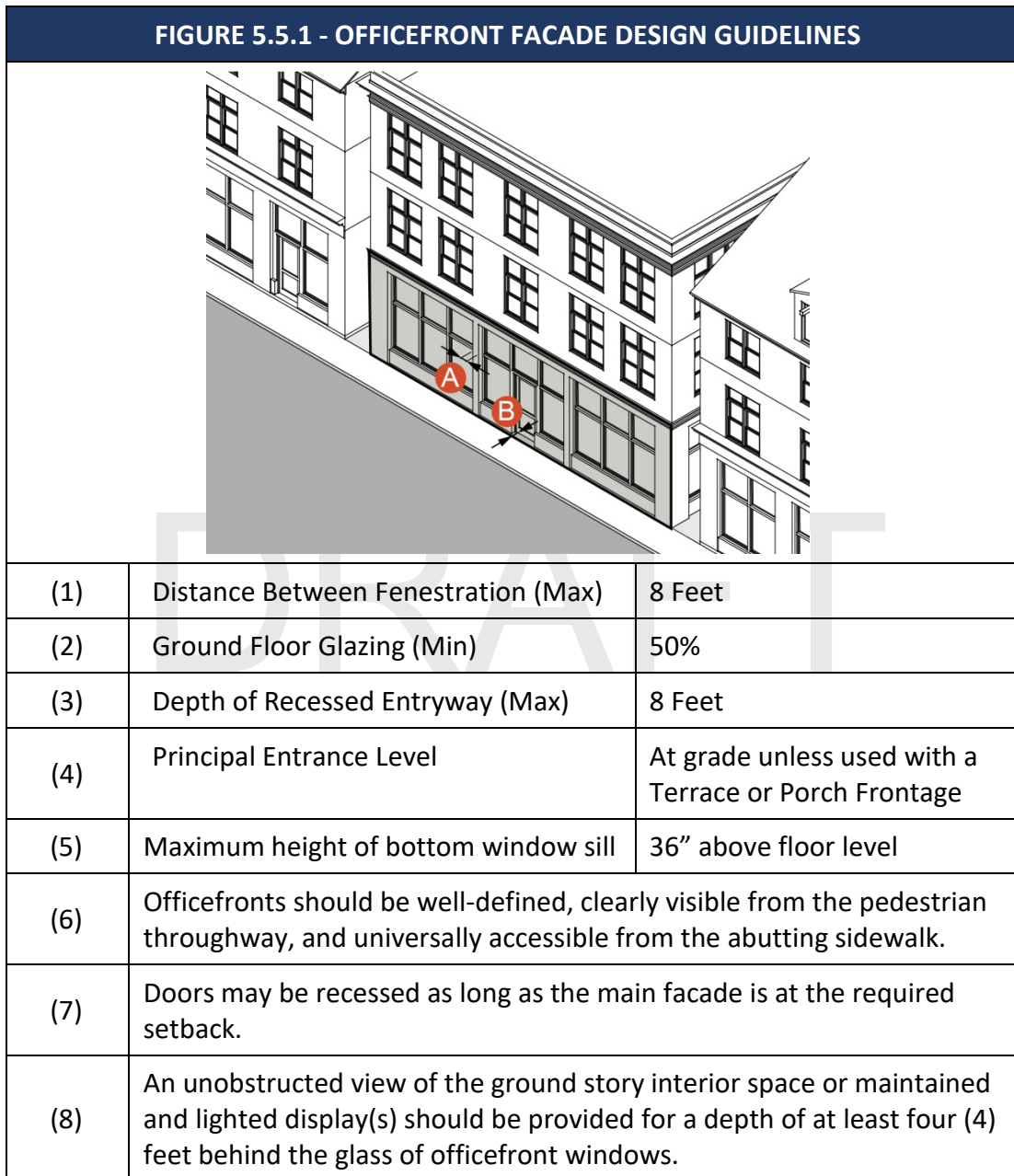

3. **Civic Frontage.** A ground floor façade type that is associated with civic uses. Entrances may be at grade or may be elevated but should be very prominently indicated. Percent of fenestration may be higher or lower than the other façade types.

FIGURE 5.5.1 - CIVIC FRONTAGE DESIGN GUIDELINES

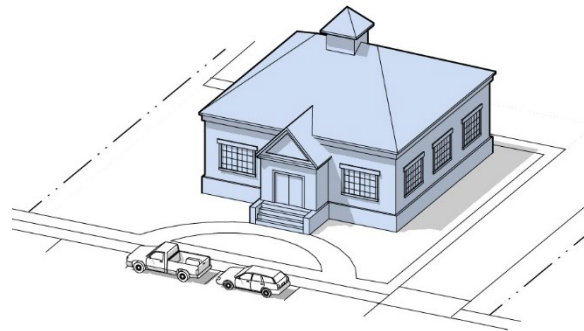

(1)

This frontage type does not have typical dimensions or design standards.

J. Ground Level Façade Activation. While the overall composition of a façade is important, the greatest amount of detail needs to be reserved for the ground floor. This is the area that garners the most attention and view for pedestrians. Design guidelines for street-level façade treatments and other small activation methods in the **Planned Development District** are identified below:

1. Storefront Windows and Moveable Facades. Where publicly-oriented ground floor commercial uses as present, retractable storefront windows and moveable facades contribute to the vitality of the Public Realm and allow internal uses to visually “spill out” onto the sidewalks, activating them and enhancing the pedestrian experience.
2. Awnings/Overhangs/Canopies. Overhangs protect pedestrians from the elements, reduce solar gain, and delineate the base of the building from the upper stories. These façade elements are encouraged in the Industrial District and should be visually consistent with one another and create a sense of a “ceiling” on the public realm. Awnings and other elements projecting over the Building Frontage Zone are encouraged in the Planned Development District and must maintain a clearance of 8 feet in height and comply with all applicable Town requirements.
3. Arcade. This building component provides a recessed ground floor level of the building facade with the upper floors extending over this space. The building facade for the upper floors are supported by a colonnade. The arcade is intended for buildings with ground floor commercial uses. The arcade must have a have a minimum height clearance of 14 feet and depth of 12 feet.
4. Gallery. This building component provides a facade set back from the street right-of-way line with an attached one or two story cantilevered balcony or colonnade that is built

within the Building Frontage Zone. A gallery is intended for buildings with ground floor commercial, hospitality or retail uses. A gallery must maintain a minimum height clearance of 14 feet and depth of 12 feet.

5. Projecting Signs. Where publicly-oriented ground floor commercial uses occur, signage that projects from the street facing building façade is encouraged such as blade signs, vertical banners, marque signs, and sandwich board signs subject to the required of Section **XXX** of the Zoning Bylaw.
6. Art Murals. Murals that are directly painted onto the exterior wall of a building or screen printed, sewn, or adhered onto a canvas-like material that is mounted flush with the facade of a building may be appropriate in the Industrial District when intended to be viewed by pedestrians and compliment outdoor amenity spaces. Art murals should be no larger than 1,000 square feet with a maximum width of 75 feet and a maximum height of 50 feet.

FIGURE 5.X.1 - FACADE ACTIVATION
Façade Activation

DRAFT

6.0 SIGNS

6.1. INTENT

The intent of these sign design standards is to provide property owners and business occupants an opportunity for effective identification subject to reasonable, yet appropriate conditions for identifying goods sold or produced or services rendered in the designated zoning districts, and maintain and enhance the quality of Winchendon's appearance by:

- A. Controlling the size, location and design of temporary and permanent signs so that the appearance of such signs will reduce sign clutter, be aesthetically harmonious with their surroundings, and will enhance the overall appearance of the built environment.
- B. Ensuring that signs are located and designed to maintain a safe and orderly pedestrian and vehicular environment; and reduce potentially hazardous conflicts between commercial or identification signs and traffic control devices and signs.
- C. Providing a pleasing overall appearance, historic setting, and community character which is vital to economic attractiveness of the Downtown Winchendon area;
- D. Allowing signs appropriate to the planned character of the zoning districts within the context of commercial corridors, industrial areas and business parks, and neighborhoods of different scale and intensity; and
- E. Promoting the public safety, welfare, convenience and enjoyment of the residents of Winchendon.

6.2. APPLICABILITY

- A. The provisions of this section will **compliment** the Winchendon Zoning Bylaw, Article 9.
- B. Nothing contained in this section shall be construed as the content-based regulation of sign messages prohibited by the federal or state constitution, statutes, or court decisions.
- C. Nothing contained in this section shall be construed to conflict with M.G.L. Chapter 85, Section 8 & 9 or M.G.L. Chapter 93, Sections 29 through 33, as amended.

6.3. SPECIAL PERMIT REVIEW

- A. Review Criteria.** Signs permitted by Special Permit require supplemental review and must meet certain performance standards for the issuance of a sign permit. The Planning Board shall serve as the Special Permit Granting Authority (SPGA) for the purpose of reviewing Special Permit applications for signs under this section. In its discretion to approve or deny a special permit to authorize a sign, the SPGA shall consider the following criteria:

1. Design of the sign as an effective means of communication.
2. Compatibility with the visual character of the surrounding area.
3. Appropriate sizing for the location.
4. The potential for adverse effects on nearby properties and pedestrian and traffic safety.

B. Concurrent Applications. Review of Special Permit applications that appear before the Planning Board for projects additionally requiring site plan review may appear concurrently before the board in accordance with the submission and procedure requirements for such applications.

6.4. SIGN MAINTENANCE, ABANDONMENT AND REMOVAL

- A. All signs, including nonconforming signs, together with any supports, braces, anchors, and other supporting hardware, must be maintained in good condition or state of equivalent quality to which was approved or required by the Town. If the Zoning Enforcement Officer is of the opinion that a sign is not secure, safe or in good state of repair, it shall give written notice of this fact to the person responsible for the maintenance of the sign. If the defect in the sign is not corrected within the time permitted, the Zoning Enforcement Officer may revoke the permit to maintain the sign and may remove the sign and keep possession of same until the owner pays the cost of removal.
- B. When an existing sign is removed, replaced, or repaired, all supports, braces, anchors, and other supporting hardware that is no longer required must be removed, and any surfaces baring evidence of attachment must be repaired.
- C. An on-premises sign advertising an activity, business, service or product must be removed or the sign face replaced with a blank face within 60 days of the activity, business, or service promoted by the sign being discontinued on the premises where the Sign is displayed.
- D. If the use is not reestablished or a new use is not established within two (2) years, then the entire sign structure and mounting hardware must be removed.

6.5. MAXIMUM BUILDING SIGNAGE AND SIGN COPY AREA

- A. The maximum square footage of all signage for a building in the specified zoning district shall be the combined length of all building primary street frontage multiplied by two. This includes any combination of Permanent Principal Signs in accordance with the standards established in Figure 6.9.2 for individual sign types.
- B. For A-frame, awning/canopy, building mounted, freestanding, and projecting signs, the sign copy area shall be considered to include all lettering, wording, and accompanying designs and symbols, together with the background, whether open or enclosed, on which they are

displayed, but not including any supporting framework and bracing that are incidental to the display itself. Only one side of a projecting sign shall be counted in computing the total square feet of signs on a sign frontage.

- C. For a sign painted upon or applied to a building, the area shall be considered to include all lettering, wording, and accompanying designs or symbols, together with any background of a different color than the natural color of the building.
- D. For a sign consisting of individual letters or symbols attached to or painted on a surface, building, canopy, awning, wall or window, the area shall be considered that of the smallest rectangle or other geometric shape that encompasses all of the letters or symbols.

6.6. SIGN ILLUMINATION

Conforming signs may be illuminated according to the following standards:

A. General. Illuminated signs indicating if a business is open must be turned off except during the hours of operation.

B. External Illumination.

1. An externally illuminated sign is characterized by the use of artificial light reflected off the surface of a sign.
2. External light sources must be shielded so that they illuminate only the face of the sign and do not shine directly onto a public right-of-way or onto adjacent properties.
3. Light fixtures that project from the facade of a building for externally illuminated signs are exempt from setback requirements but should be simple and unobtrusive in design and not obscure the sign content.

C. Internal Illumination.

1. An internally illuminated sign is characterized by the use of artificial light projecting through or from behind the surface of a sign.
2. Channel letters may be internally lit or back-lit.
3. Blade signs may be internally lit if the background is opaque or of a darker color than the message of the sign and the lettering is no more than 50% of the surface area of the sign
4. Exposed neon is only permitted for wall or windows signs.

D. Backlit (i.e., Halo) Signs. Backlit Signs shall light lettering and logo and other related sign elements only, and lighting design shall be such that no excess light spill or glare results from the back lighting fixtures and/or source. The back lit sign shall not increase the measurable vertical light level at a point 20 feet distant from the Sign in any direction.

E. Neon Signs. Neon signs are permitted by Special Permit as an alternative form of Band, Blade,

or Window sign subject to the same design standards in Figure 6.9.2.

6.7. STRUCTURES AND INSTALLATION

- A. Support Elements.** Supports and braces shall be designed as an integral part of the sign design and hidden from public view to the maximum extent practical.
- B. Electrical Service.**
1. All electrical fixtures, devices, circuits, conduits, raceways or apparatus used to illuminate, move or project any sign shall be installed and maintained in accordance with the building code and the electrical code. Electrical permits are required for signs with an electrical component.
 2. When electrical service is provided to freestanding signs, all such electrical service is required to be underground and concealed.
 3. Conduits and other components of a sign illumination system shall be designed as an integral part of the sign design and hidden from public view to the maximum extent practical.
- C. Limitation on Attachments and Secondary Uses.** All permitted sign structures and their associated landscape areas shall be kept free of supplemental attachments or secondary uses including, but not limited to, supplemental advertising signs not part of a permitted sign, light fixtures, newspaper racks, or trash containers. The use of sign structures and associated landscape areas as support structures for outdoor product display is prohibited.
- D. Durable Materials.** All permanent signs permitted by this section shall be constructed of durable materials capable of withstanding continuous exposure to the elements and the conditions of an urban environment.

6.8. SIGN PLACEMENT AT INTERSECTIONS

For parcels located at the corner of two intersecting public or private streets including, but not limited to, driveways and service lanes associated with commercial and/or business sites, a clear view triangle shall be maintained. The triangle shall be the area formed by measuring a distance of 20 feet from the corner of the parcel along the lot lines and connecting the end points so as to establish a triangle on the area of the lot adjacent to the street and/or drive intersections. No sign, nor any part of a sign, other than a supporting pole or brace measuring 18 inches or less in width or diameter, shall be located between 3 feet and 10 feet above the grade within this sight triangle.

6.9. PERMITTED ACCESSORY AND PRINCIPAL SIGNS

- A. Permanent Accessory Signs Standards.** Permanent Accessory Signs shall meet the standards

set forth in Tables 7.1 and 7.3.A through E below:

FIGURE 6.9.1 - PERMANENT ACCESSORY SIGNS				
Sign Types	R	C	I	PD
A. A-Frame/Sandwich Board Signs				P
B. Display Case				P
C. Directory Signs and Nameplates				P
D. Other Accessory Signs				SP
P - Permitted by Right with Specifications under this Article				
SP- Permitted by Special Permit from the Planning Board.				

B. Permanent Principal Signs Standards. Permanent Principal Signs shall meet the standards set forth in Tables 7.2 and 7.4.A through K below:

FIGURE 6.9.2 - PERMANENT PRINCIPAL SIGNS				
Sign Types ¹	R	C	I	PD
A. Awning and Canopy Signs				P
B. Bracket Signs				P
C. Blade and Projecting Signs				P
D. Freestanding and Yard Signs				P
E. Vertical Blade/Banner Signs				P
F. Marquee Signs				P
G. Suspended Signs				P
H. Wall Mural				P
I. Window Signs				P
J. Wall Signs				P
K. Other Principal Signs				SP
P - Permitted by Rights with Specifications under this Section				
SP - Permitted by Special Permit by the Planning Board				
1. All signs internally illuminated and/or including a static or dynamic message board shall require a special permit.				

FIGURE 6.9.3 - PERMANENT ACCESSORY SIGN STANDARDS

professional manner free from chipping paint, cracks, loss of letters, and other damages.

A. A-FRAME AND SANDWICH BOARD SIGNS



DEFINITION:

A freestanding portable sign, not secured or attached to the ground or any building or structure, composed of a sign panel and supporting structure or one or more panels which form both the structure and sign face, and which is intended to be placed in a sidewalk or pedestrian way.

ZONING DISTRICTS ALLOWED:

See Figure 6.9.1

SIGN SPECIFICATIONS:

Number of Signs:	1 per business unit max.
Placement:	8 feet from principal entrance max.
Sign Height:	4 feet max.
Sign Width:	2 feet max.
Sign Area:	8 sq. ft. max per side.
Illumination:	Prohibited

OTHER FUNCTIONAL STANDARDS:

One (1) Sidewalk sign is permitted per ground story tenant.

Sidewalk signs may be placed outdoors on site or on a public sidewalk during business hours and must be removed when the business is closed.

Sidewalk signs displayed on a public sidewalk are prohibited from interfering with pedestrian travel and shall leave clear an accessible walkway area of 4 feet minimum.

A sidewalk sign must be vertically oriented, with a height greater than its width and made of wood, metal, or slate (chalkboard).

A sidewalk sign is not permitted to be illuminated or contain any electronic components.

A sidewalk sign may not be placed outdoors when high winds, heavy rain, or heavy snow conditions are present. The Department Public Works may remove a sidewalk sign during snow removal operations, and is not liable for damage to a sidewalk sign caused by snow removal operations.

Design/Construction: Constructed of a min. ¾" high density exterior grade compressed wood or molded plastic of weight and durability to withstand wind gusts and maintained in a

B. DISPLAY CASE

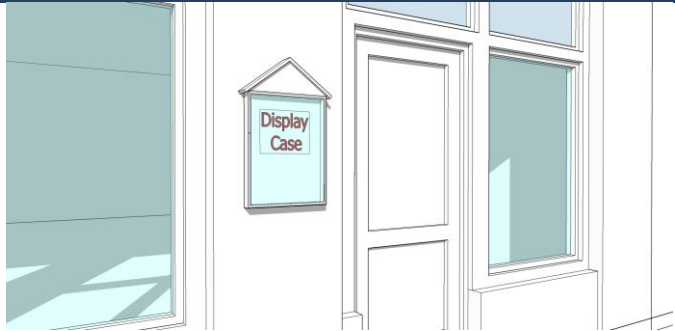

DEFINITION:

A wall mounted, lockable, framed cabinet with a transparent window to display a changeable menu or list of event show times. Display cases are intended to be viewed at close range by pedestrians.

ZONING DISTRICTS ALLOWED:

See Table Figure 6.9.1

SIGN SPECIFICATIONS:

Number of Signs:	1 per 4 business; 4 max. for theaters per frontage.
Placement:	Shall be attached to the building wall on the primary or secondary frontage.
Sign Height:	Top of sign case shall not exceed 7 feet from grade.
Sign Width:	4 feet max.
Sign Area:	6 feet max.
Illumination:	Non-illuminated, or illuminated from inside the display case.

OTHER FUNCTIONAL STANDARDS:

Outdoor display cases for theaters may be larger but shall not exceed 12 sq. ft.

C. DIRECTIONAL SIGNS



DEFINITION:

A traffic, direction or informational on-premises sign located on private property at the curb cuts of an establishment giving direction or information as to entrance, exit and/or the like. Such signs may contain a logo or other information identifying the use of the premises so long as such information is for direction and point of reference and not for advertising purposes. Directional Signs may include information and directions necessary or convenient for persons accessing the property including signs marking entrances and exits, parking areas, one-way drives, rest rooms, pickup and delivery areas, loading zones and the like.

ZONING DISTRICTS ALLOWED:

See Figure 6.9.1

SIGN SPECIFICATIONS:

Number of Signs:	Unlimited, except that directional signs placed near driveway openings shall be limited to a max of one (1) at each location or access point per direction of travel. (e.g., One way ingress driveways are allowed one (1) sign, two-way driveways are permitted two (2) signs.
Placement:	Building-mounted directional signs must be affixed flat against the building wall, no higher than the 1st floor.
Sign Height:	Building Mounted: Max 8' from grade Freestanding: Max 3' from grade
Sign Area:	3 sq. ft. per face
Illumination:	Internal illumination or non-illuminated, only

D. DIRECTORY AND NAMEPLATE SIGNS



DEFINITION:

A single sign comprised of uniform individual signs placed or displayed in sequence and which may provide information in a list, roster, or directory format; generally a sign listing the names and/or use, or location of more than one business, activity or professional office conducted within a building, group of buildings or commercial center.

ZONING DISTRICTS ALLOWED:

See Figure 6.9.1

SIGN SPECIFICATIONS:

Number of Signs:	1 per address unless the street frontage of said institution exceeds one hundred (100) feet, then one (1) sign for each hundred (100) feet is allowed but in no event more than three (3) such signs per address.
Placement:	May be building mounted or mounted on a low profile freestanding sign
Sign Height:	Max 6' above grade
Sign Area:	Max 16 sq. ft.
Illumination:	Non-illuminated, Internally-illuminated or indirectly illuminated

OTHER FUNCTIONAL STANDARDS:

Directory signs may be placed at points nearest pedestrian entry to businesses within a multi-tenant development and/or within (pedestrian) open spaces.

A nameplate shall only provide the name, address or logo of an owner, tenant, and/or the building to which it is affixed.

Nameplates shall consist of either a panel or individual characters applied to building walls within 4 feet of an entrance to the building.

E. DISPLAY CASE

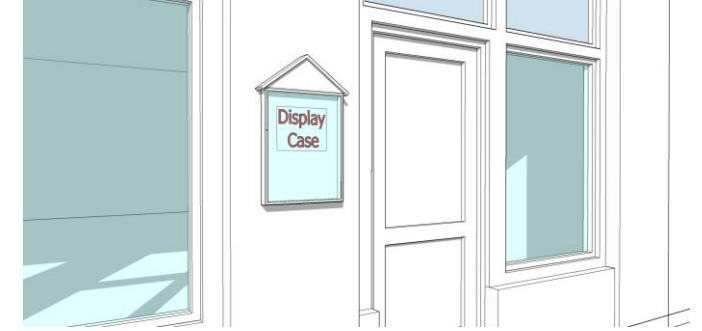

DEFINITION:

A wall mounted, lockable, framed cabinet with a transparent window to display a changeable menu or list of event show times. Display cases are intended to be viewed at close range by pedestrians.

ZONING DISTRICTS ALLOWED:

See Figure 6.9.1

SIGN SPECIFICATIONS:

Number of Signs:	1 per 4 business; 4 max. for theaters per frontage.
Placement:	Shall be attached to the building wall on the primary or secondary frontage.
Sign Height:	Top of sign case shall not exceed 7 feet from grade.
Sign Width:	4 feet max.
Sign Area:	6 feet max.
Illumination:	Non-illuminated, or illuminated from inside the display case.

OTHER FUNCTIONAL STANDARDS:

Outdoor display cases for theaters may be larger but shall not exceed 12 sq. ft.

DRAFT

FIGURE 6.9.4 - PERMANENT PRINCIPAL SIGN STANDARDS

A. AWNING AND CANOPY SIGNS



DEFINITION:

A sign suspended from, attached to, supported from or forms part of a roof-like cover made of canvas or similar material which projects from the wall of a building for the purpose of shielding a doorway or window from the elements, not including a marquee. (An awning or canopy may or may not have signage.)

ZONING DISTRICTS ALLOWED:

See Figure 6.9.2

SIGN SPECIFICATIONS:

Number of Signs:	1 per business unit
Placement:	Top of awning may not extend above the bottom of the second story window of building. Canopy sign must be 10' min. from another canopy sign
Sign Height:	Max. 10' from grade to sign bottom Min. clearance above sidewalk 8.'
Sign Area:	The lesser of 1 sq. ft. of sign area per linear foot of awning width; or 75% of valance or face and/or 25% of the sloping plane
Sign Lettering:	5" min.; 10" max. of awning valance 18" max. of sloping plane
Illumination:	Canopies may be non-illuminated, internally-illuminated or indirectly illuminated If sign letters or logos are placed on the awning, only the face area containing the letters or logos may be illuminated. All illumination must be internal behind the surface of the awning/canopy.

OTHER FUNCTIONAL STANDARDS:

Signage on canopy shall be limited to the face or may project above.

Awning signs shall not be internally illuminated or backlit.
Canopy signs may be backlit.

DRAFT

B. BRACKET SIGNS

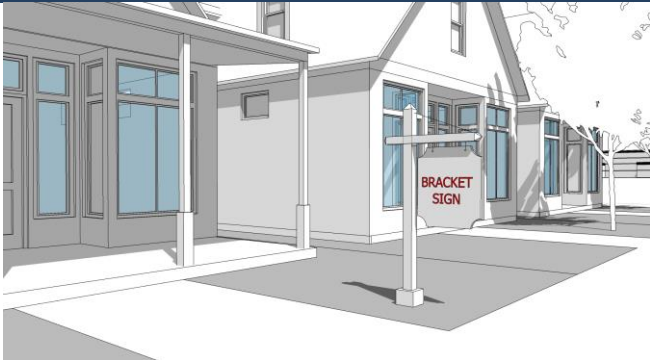

DEFINITION:

A freestanding sign attached to the ground by one or more support structures that is not higher than 5 feet and hangs from a bracket or support.

ZONING DISTRICTS ALLOWED:

See Figure 6.9.2

SIGN SPECIFICATIONS:

Number of Signs:	1 per shopfront
Placement:	Within the Sign Band
Sign Area:	9 Square Feet Maximum
Sign Structure Height:	5 Feet Maximum
Sign Area Height:	3 Feet Maximum
Sign Area Width:	3 Feet Maximum
Sign Structure Area Depth:	6 Inches Maximum

illumination:	Band signs may be externally illuminated or backlit. Neon is permitted
---------------	---

OTHER FUNCTIONAL STANDARDS:

A bracket sign must be located at least 25 feet from another bracket sign.

The hanging bracket must be an integral part of the sign design.

A bracket sign can only be externally illuminated in accordance with Section 6.XX.

C. BLADE AND PROJECTING SIGNS



DEFINITION:

A building mounted sign attached to, and extending from, a building or support beam in whole or in part which extends beyond said building.

ZONING DISTRICTS ALLOWED:

See Figure 6.9.2

SIGN SPECIFICATIONS:

Number of Signs:	1 per business unit
Placement:	Projecting signs may encroach into the public right-of-way but shall not be located within 3' to the closest curb line. Sign shall be mounted a min. of 6" away from the building.
Sign Height:	Min 10' from grade to the bottom of the sign.
Sign Area:	Max 20 sq. ft. for each business unit. Wall signs are counted toward total signage area limit for the building.
illumination:	Non-illuminated or externally illuminated. Down-directed, fully-shielded fixtures only. Accent lighting may consist of special lighting strips (non-scrolling or non-flashing LED or neon) in order to highlight logos or individual letters but does not dominate sign and shall not be considered internal illumination for the purposes of this section.

OTHER FUNCTIONAL STANDARDS:

Blade signs may be double-sided

Blade signs shall be permitted only for uses that have a principal entrance on the first floor.

6 sq. ft. max. sign area

4' max. sign width and height

8" max. letter height

Clear Height: 8' min.; 14' max. measured from the street grade to the top of the light standard or supporting standards, whichever is greater.

All signs overhanging a public way must be covered by an insurance policy naming the Town of Winchendon as coinsured for an amount to be established by the Town, evidence of which must be provided upon application for a sign permit from the Department of Inspectional Services.

D. FREESTANDING SIGNS

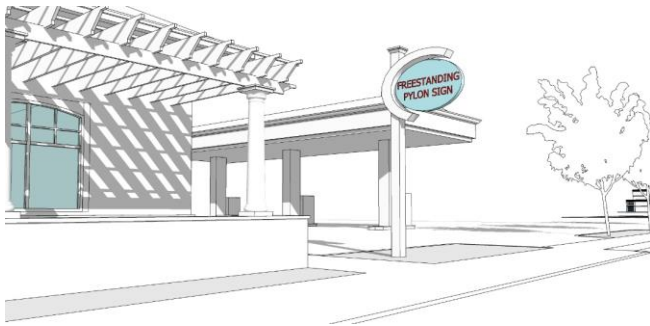

DEFINITION:

A sign (not including sandwich board signs) that is erected or mounted on its own self-supporting permanent structure or base detached from any supporting elements of a building.

ZONING DISTRICTS ALLOWED:

See Figure 6.9.2

SIGN SPECIFICATIONS:

Number of Signs:	1 for each street frontage maximum
	For home occupations: Max 1 sign
Placement:	When more than 1 freestanding sign is proposed on a site with multiple frontages, a minimum of 60 linear feet shall separate each sign. No portion may project into, over or otherwise encroach on a public right of way. Freestanding signs must have a 6' min setback from any interior side lot line and 30' from any residential zoning district
Sign Height:	Max. 10 ft above grade
Sign Area:	Max 40 sq. ft. When only 1 is proposed where 2 are permitted, the maximum sign area may be increased subject to approval and a release of rights to additional freestanding signs for the duration of use of the single larger sign, evidenced by a recordable form of acceptance signed by the property owner.
Illumination:	Permitted per requirements in Section 3263 C.
Landscaping:	Required landscaped area around base of the sign equal to 12 sq. ft. consisting of shrubs and/or perennial ground cover plants on permeable ground cover or raised bed with sod and plantings.

DRAFT

D. FREESTANDING SIGNS, Continued

OTHER FUNCTIONAL STANDARDS:

General:

Freestanding signs may be double-sided.

Freestanding signs may not be located in the public R.O.W.

Freestanding signs may be externally illuminated or backlit.

Banks:

Total sign area not to exceed 1 1/2 sq. ft. per 1 linear foot of building frontage.

Freestanding or ground sign max. 40 sq. ft.

Freestanding or ground sign max. 10 from grade to bottom of sign.

1 freestanding or ground sign per business.

Gas/Service Stations:

Freestanding sign max. of 30 sq. ft.; 1 max. per street frontage.

Ground signs and monument signs may be substituted for free standing signs.

Electronic display signs showing gas prices may be incorporated into freestanding signage and may be double-faced.

Gas Pump/Service Island - Canopy sign max. of 50 sq. ft. for each side of the service island canopy. Signs shall extend horizontally a max. of 80% of the width of the service island canopy on which it is displayed.

Freestanding and Gas Pump/Service Island signs may be non-illuminated, internally-illuminated, or indirectly illuminated.

E. VERTICAL BLADE/BANNER SIGNS



DEFINITION:

A tall, narrow, two-sided sign that is attached to and projecting perpendicularly from the facade of a building that identifies a commercial establishment. Vertical blade/ banner signs are intended to be viewed by pedestrians and motorists from a distance.

ZONING DISTRICTS ALLOWED:

See Figure 6.9.2

SIGN SPECIFICATIONS:

Number of Signs:	1 sign per 15 feet of façade width; 4 signs max.
Placement:	Signs shall be placed above the first story. Signs may encroach into the public right-of-way but shall not project more than 3' from the building facade. Sign shall be mounted a minimum of 6" away from the building facade.
Sign Height:	10 feet max.
Sign Width:	4 feet max.
Sign Area:	Max 20 sq. ft. for each business unit. Wall signs are counted toward total signage area limit for the building.
Sign Lettering:	75% of sign width maximum
Illumination:	Non-illuminated or externally illuminated. Down-directed, fully-shielded fixtures only.

OTHER FUNCTIONAL STANDARDS:

Vertical Blade/Banner signs may be double-sided

Blade signs shall be permitted only for uses on site.

No portion of the sign may project above the roof-line of the facade to which it is attached.

Information type is limited to business name and logo. Additional information is prohibited.

F. MARQUEE SIGNS



DEFINITION:

A sign painted on, attached to, or supported by a marquee—a permanent roof-like shelter, either open or covered, extending from part or all of a building face and constructed of some durable material which may or may not project over a public right-of-way.

ZONING DISTRICTS ALLOWED:

See Figure 6.9.2

SIGN SPECIFICATIONS:

Number of Signs:	Max. 1 per marquee per building.
Placement:	Primary facades only
Sign Height:	Min 10' from grade to bottom of the sign.
Sign Area:	Max 75% of marquee structure's width and height. Marquees signs counts toward total signage area limit for the building.
Projection:	6' min./10' max.

OTHER FUNCTIONAL STANDARDS:

Max. width shall be the width of the building frontage

Max. height of the sign is 50% of the first story height

Min. distance from the curb is 3'

New marquee signs shall be allowed only for theaters, performing arts venues, and sports arenas.

Marquee signs shall be located above the principal entrance of the building.

Marquee signs shall be cantilevered or supported from above; Columns or posts are prohibited.

Changeable message boards with removal physical lettering or electronic message displays may be permitted.

G. SUSPENDED SIGNS



DEFINITION:

A small, two-sided sign mounted to the underside of an awning, canopy, or roof of a porch that identifies a commercial establishment. Suspended signs are intended to be viewed by pedestrians at close range on the same side of the street.

ZONING DISTRICTS ALLOWED:

See Figure 6.9.2

SIGN SPECIFICATIONS:

Number of Signs:	1 per business unit
Placement:	A suspended sign may not extend beyond the edge of the awning or canopy it is mounted below. Clear height over the sidewalk is 8' min. Information type is limited to business name or logo. Additional information is prohibited.
Sign Height:	3 feet max
Sign Width:	3 feet max
Sign Area:	4 sq. ft. per side max.

Illumination: Non-illuminated or externally illuminated. Down-directed, fully-shielded fixtures only.
Accent lighting may consist of special lighting strips (non-scrolling or non-flashing LED or neon) in order to highlight logos or individual letters but does not dominate sign and shall not be considered internal illumination for the purposes of this section.

H. WALL MURALS

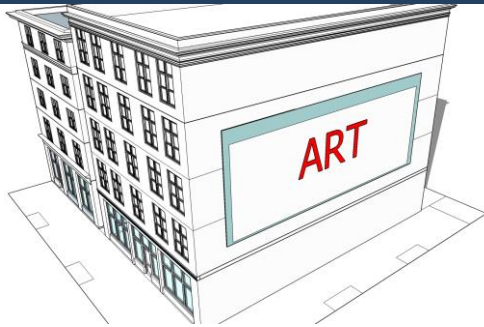

DEFINITION:

A sign that is directly painted on to the exterior wall of a building or screen printed, sewn, or adhered onto a canvas-like material that is mounted flush with the facade of a building that identifies a commercial establishment. Wall murals are intended to be viewed by pedestrians and motor vehicles from a distance.

ZONING DISTRICTS ALLOWED:

See Figure 6.9.2

SIGN SPECIFICATIONS:

Number of Signs:	1 per building
Placement:	On the building façade in a space generally visible to the public.
Sign Area:	1,000 sq. ft. max.
Sign Height:	50 feet max.
Sign Width:	50 feet max.
Height above the Ground:	1 story min.
Illumination:	Only external illumination is permitted.

OTHER FUNCTIONAL STANDARDS:

Lettering or logos must be limited to no more than 20% of the surface area of the wall mural.
Requires Special Permit from Planning Board

I. WINDOW SIGNS



DEFINITION:

Any non-illuminated or electronic/electrical static sign (with the exception of neon which shall be permitted as a window sign) which is (a) painted on, applied to, attached to or projected upon the glass area of a building, including doors, whose identification, message, symbol, insignia, visual representation, logo type, or any other form which communicates information is intended to be read from off-premises, contiguous property or a public right-of-way and/or (b) affixed to or within twelve (12) inches of windows of a building, whether temporary or permanent, which may be viewed from the exterior of the building.

ZONING DISTRICTS ALLOWED:

See Figure 6.9.2

SIGN SPECIFICATIONS:

Number of Signs:	1 per window and/or 1 per door max.
Placement:	3' min. height from sidewalk to bottom of the sign. See definition above.
Sign Area:	25% of the window area max. Window signs count toward total signage area limit for the building.
Sign Lettering:	18" max lettering height.

Illumination: Window signs shall not be illuminated however the use of neon is otherwise permitted

OTHER FUNCTIONAL STANDARDS:

Characters and logos shall be placed directly on the window or hang no more than 12" from the glass.
Items placed more than 12" from the glass shall not be considered a sign.

Information type is limited to business name, logo, hours of operations, and product types.

Window signs shall not interfere with the primary function of the window, which is to enable pedestrians and public safety personnel to see through windows into the premises and view product display.

J. WALL SIGNS



DEFINITION:

A sign attached to, painted on or erected against a wall, parapet, fascia, or a building or structure with the exposed face of the sign in a plane parallel to the vertical face of the building or structure.

ZONING DISTRICTS ALLOWED:

See Figure 6.9.2

SIGN SPECIFICATIONS:

Number of Signs:	One (1) wall is sign permitted per business frontage on a Primary or Secondary Street in the DESIGNATED ZONING DISTRICT.
Placement:	Wall sign shall project a maximum of 15 inches from building wall. Shall extend horizontally a maximum of 80% of the width of the building wall on which it is displayed.
Sign Area:	Max of 1 sq. ft. for each linear foot of primary business façade of each business unit. If business has frontage on two or more streets, the primary façade contains the primary entrance. Max ½ sq. ft. for each linear foot of façade on side with secondary entrances. Two or more businesses served by a single common building entrance are considered 1 business for sign computation purposes; Max 2 sq. ft. for each linear foot of building frontage for the entrance.

OTHER FUNCTIONAL STANDARDS:

Banks:

Wall sign max. 1 sq. ft. of sign area per linear foot of building frontage.

Wall signs max. 10' above grade to bottom of sign.

1 Wall sign per business frontage.

Wall signs may be non-illuminated, internally-illuminated, or indirectly illuminated.

The sign shall not obscure architectural features of the building (including but not limited to cornices, lintels, transoms) to which the sign is attached.

Gas/Service Stations:

Building wall sign max. 1 sq. ft. for each linear foot of building frontage.

No part of a wall sign shall extend above a roofline.

Wall signs may project a max. of 15" from a service island canopy.

Wall signs may be non-illuminated, internally-illuminated, or indirectly illuminated.

General:

Overall Dimensions: Each wall sign may not exceed 50 feet in length, 4 feet in width, and 80 square feet in area.

Sign length maximum of 50 feet and sign width maximum of 3 feet in the DESIGNATED ZONING DISTRICT.

Height above ground: The top of the sign shall be no more than the lesser of the floor level of the second floor or 25' in the DESIGNATED ZONING DISTRICT.

Wall signs may be externally illuminated or backlit in the DESIGNATED ZONING DISTRICT.

Neon wall signs are permitted in in the DESIGNATED ZONING DISTRICT by Special Permit from the Planning Board.



6.10. TEMPORARY SIGNS

COMMENTARY: The 2015 U.S. Supreme Court ruling in *Reed v. Town of Gilbert, Arizona* relates to content-neutrality and on-premises vs off-premises signs. The following is a brief synopsis of the ruling related to these issues:

Content-Neutrality: The U.S. Supreme Court, in its 2015 ruling in *Reed v. Town of Gilbert, Arizona*, made it clear that for a sign regulation to be considered “content-neutral”, you should not have to read the sign to determine what type of sign it is, or how to regulate the sign. Because of *Reed*, real-estate, election, construction signs, etc. are now considered content-based signs because you define them by their content. Content-neutrality also impacts the regulation of all signs, not just temporary signs, and often becomes a question of interpretation.

Content-neutral sign regulations define signs based on their size, height, structure, placement, material, shape, or other characteristics, not content. While some court cases before *Reed* allowed the regulation of a limited number of content-based signs, such as real estate or political signs, these decisions have been effectively overturned by the *Reed* decision and should no longer be considered good law. In light of the *Reed* decision, the best approach is to eliminate all content-based language from the sign regulations, with the only exceptions being signs that must be defined by content in order to achieve a compelling governmental interest.

On-Premises versus Off-Premise Signs: The *Reed* decision left uncertainty as to the legality of regulations that consider the content of signs to determine if the sign is an on-premise sign or an off-premise sign. This is important for permanent signage because of a general concern about allowing billboard signs, which are traditionally off-premise signs. With temporary signs, this distinction may be less important, as discussed earlier, and may only be applicable when addressing larger temporary signs, such as balloon signs.

A. Terminology.

1. Temporary Sign. Portable signs or any sign not permanently embedded in the ground, or not permanently affixed to a building or sign structure, which is permanently embedded in the ground, are considered temporary signs.

B. Permitted Temporary Signs by Zoning District.

FIGURE 6.10.1 – PERMITTED TEMPORARY SIGNS				
Zoning District	R	C	I	PD
Window Signs				
Real Estate and Construction Signs				
Transient Event Signs				
Banners				
Vehicle Signs				
Other Temporary Signs				
Permitted by Right with Specifications under this Article Permitted only for approved home occupations, churches, schools, and related institutions intended for public access Permitted by Special Permit. See Special Permit Criteria under Section XXX				

C. Permitted Temporary Sign Standards. Unless otherwise specified, temporary signs are permitted for a maximum of sixty (60) total days, shall not be illuminated, and do not require a sign permit, but are subject to the following standards:

1. **Temporary Window Signs:** Temporary signs not meeting the requirements for permanent signs may advertise sales, special events, or changes in the nature of an operation and are restricted to devices made of paper, posterboard, cardboard, cloth, canvas, fabric, cardboard, or other light material placed behind display windows, or markings of removable paint or marker inscribed directly on glass, if such devices and markings cover not more than 30% of window area, are not permanently mounted, and are illuminated by building illumination only, but shall not otherwise be used to advertise a continuing or recurrent activity, and shall be removed within seven (7) days after the information they display is out of date or no longer relevant.
2. **Real Estate and Construction Signs:** A temporary sign may be erected during sale, lease, rental, or construction of a building or subdivision. Such sign shall not exceed (40) forty square feet in area for premises in the designated zoning district, and in other cases shall not exceed six (6) square feet in area in residential districts and ten (10) square feet in area in other nonresidential districts. Construction signs shall not be erected prior to the issuance of a building permit, or prior to commencement of work if said work does not require a building permit.
3. **Transient Event Signs:** Temporary signs which indicate garage or yard sales, bazaars, dinners, or other nonprofit events and similar occasional uses shall comply with the Winchendon General Ordinances, and any conditions imposed in granting of licenses for such events by the Selectboard.
4. **Banners:** A temporary banner or similar sign, if permitted by the Selectboard under its authority to control use of Town ways under General Ordinances may be placed above or across a public or private street or way upon such terms and conditions as the Selectboard shall determine. When a business newly opens, the **Zoning Enforcement officer** may as a condition of site plan approval allow the placement of a banner on the premises for a

period not to exceed two weeks.

5. **Vehicles:** A truck, trailer, or other vehicle shall be construed as a temporary sign, subject to the requirements applicable to permanent signs, if placed at a location especially prepared for display through special lighting or elevation, or in the case of commercial vehicles having lettering, logos, or similar devices, if such vehicles are placed at a location more prominent than a feasible alternative on the site for a cumulative total of ten(10) or more days following written order not to do so by the Inspector of Buildings. Appeal of actions or inactions under this provision may be brought to the Board of Appeals under 13.6 of the Zoning Bylaw.
6. **Other Temporary Signs.** To be determined by the **Zoning Enforcement officer.**

FIGURE 6.11.1 – ILLUSTRATIVE EXAMPLES OF TEMPORARY SIGNS



Balloon Signs & Air-Activated Graphics

Advertising Murals

Banner Signs



Feather Signs (or Teardrop Flag)

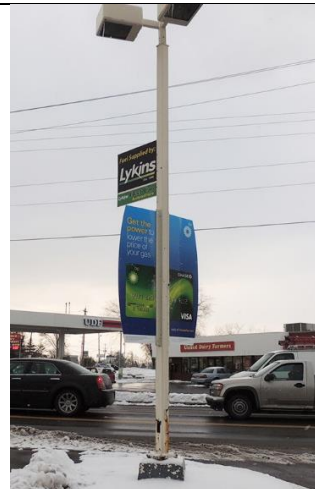

Light Pole or Support Pole Banners



People Signs



Portable Message Center Signs



Temporary Window Signs



Vehicle Signs & Wraps

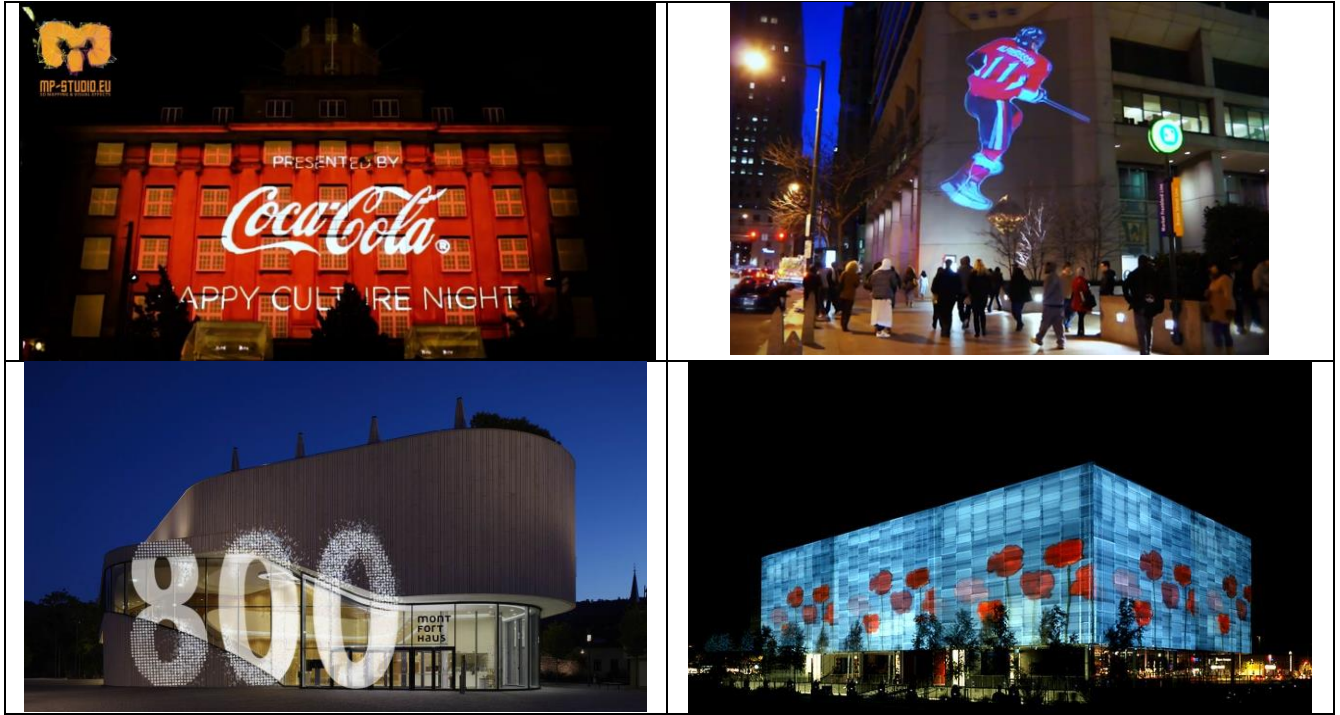

Projected-Image Signs

DRAFT



7.0 OUTDOOR AMENITY SPACE



7.1 GENERAL STANDARDS

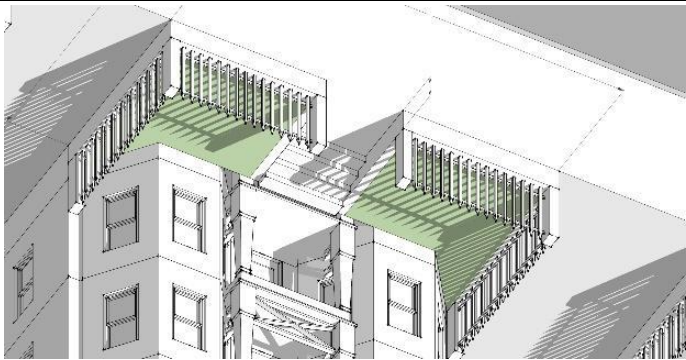

- A. **Outdoor Amenity Space Types.** Outdoor Amenity Spaces include the following types:
1. Civic Space (CS). This includes publicly-owned or controlled parks, active and passive recreation areas, civic buildings, and other gathering spaces that are fully accessible to the general public.
 2. Publicly Oriented Private Spaces (POPS). These are gathering spaces on private land primarily serving the residents, businesses, and patrons of a district or development, and accessible to the general public.
 3. Private Open Space (PS). This is open space associated with an individual building or development site and is not intended for public access.
- B. **Required Outdoor Amenity Space.** The required percentage of a development site dedicated to open space is identified for each zoning districts in **Section XXX of the Zoning Bylaw**.

7.2 OUTDOOR AMENITY SPACE DESIGN STANDARDS

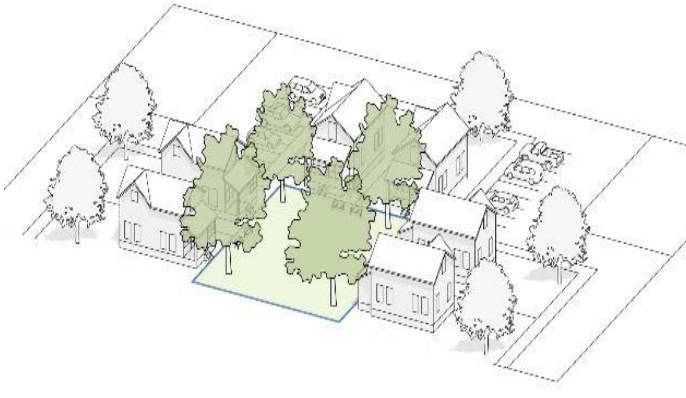
Outdoor Amenity Space types and associated design standards are identified in Table 7.2.1 below:

TABLE 7.2.1 - OUTDOOR AMENITY SPACE TYPES AND DESIGN STANDARDS	
Type	Description and General Design Standards
<p>A. Private Yard and Garden (PS)</p> 	<p><u>Description:</u> A private open space associated with multi-family or non-residential buildings not intended for public access.</p> <p><u>Design Standards:</u> Where applicable, a walkway should be provided between the public sidewalk and the primary building entrance.</p>
<p>B. Dooryard (PS)</p> 	<p><u>Description:</u> A private open space where the building façade is aligned close to the Street R.O.W. Line and defined by a low wall, decorative fence or hedge providing a strong spatial definition from the public sidewalk. The result is a small semi-private dooryard containing the principal entrance in the front yard. This type is commonly associated with ground-floor residential use</p> <p><u>Design Standards:</u> The dooryard may be slightly raised, sunken, or at-grade, and may be planted or landscaped. A paved walkway from the sidewalk to the front door is required.</p>
<p>C. Forecourt (POPS, PS)</p> 	<p><u>Description:</u> A private open space where a portion of the façade is aligned close to or at the Street R.O.W. Line, and the central portion of the façade is set back to create a courtyard with a principal entrance at-grade and space for gathering and circulation, or for outdoor shopping or restaurant seating. The forecourt may be planted or paved to join with the public sidewalk.</p> <p><u>Design Standards:</u> Forecourts should be a minimum width and depth of 12 feet; a maximum ratio of building height to forecourt width of 2:1; and enclosed by walls on 3 sides.</p>
<p>D. Community Garden (CS, POPS, PS)</p>	<p><u>Description:</u> An open space designed as individual garden plots available to residents for horticultural purposes, including storage</p>

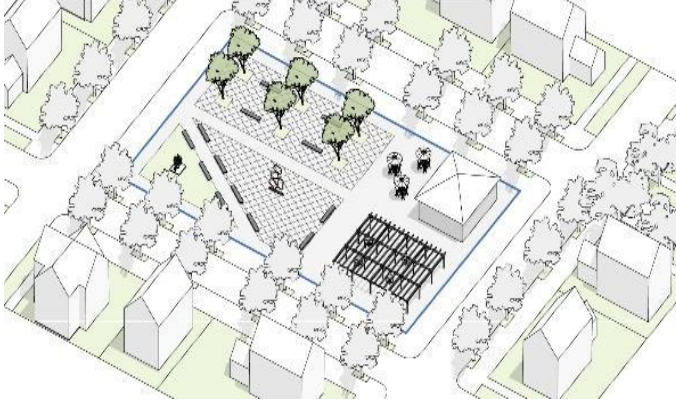
	<p>facilities for necessary equipment. Community gardens may be freestanding or incorporated as a subordinate feature of a community park, neighborhood or pocket park, or Development Site.</p> <p><u>Design Standards:</u> Community gardens should be a minimum of 5,000 S.F.</p>
<p>E. Courtyard (POPS, PS)</p>	<p><u>Description:</u> A courtyard (or court) is an enclosed open space that is open to the sky. They are often surrounded by a building or framed by buildings on at least 2 sides. Courtyards may include a variety of passive recreational activities, community gardens, and other amenities for community gatherings.</p> <p><u>Design Standards:</u> Courtyards should be a minimum of 3,000 S.F. in area and 40 feet in width.</p>
	<p><u>Description:</u> A common or green is a free-standing site with streets on all sides and landscape consisting of lawns, paths, and trees. This open space type is for active and passive recreation and gathering purposes.</p> <p><u>Design Standards:</u> Commons should be a minimum of 10,000 S.F.; 85% permeable surfaces; and 1 tree/2,000 SF on average.</p>
<p>F. Common or Green (CS, POPS)</p>	<p><u>Description:</u> A common or green is a free-standing site with streets on all sides and landscape consisting of lawns, paths, and trees. This open space type is for active and passive recreation and gathering purposes.</p> <p><u>Design Standards:</u> Commons should be a minimum of 10,000 S.F.; 85% permeable surfaces; and 1 tree/2,000 SF on average.</p>
	<p><u>Description:</u> An open space type designed for passive recreation, civic purposes, and commercial activities, with landscape consisting primarily of hardscape. Plazas are</p>
<p>G. Plaza or Square (CS, POPS)</p>	<p><u>Description:</u> An open space type designed for passive recreation, civic purposes, and commercial activities, with landscape consisting primarily of hardscape. Plazas are</p>

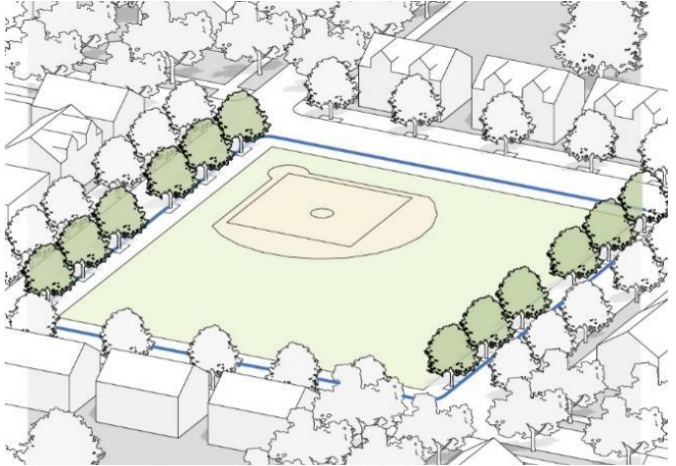
	<p>generally located in activity centers or the nexus of major circulation routes.</p> <p><u>Design Standards:</u> Squares should be a minimum of 5,000 S.F.; 50% permeable surfaces; 1 tree/2,000 SF on average; and include public seating.</p>
<p>H. Pocket Park or Playground (CS, POPS, PS)</p>	<p><u>Description:</u> An open space type designed for passive recreation consisting of vegetation, a place to sit outdoors, and playground equipment.</p> <p><u>Design Standards:</u> Pocket Parks should be a minimum of 800 S.F.; 80% permeable surfaces; and 1 tree/200 SF on average; and include seating and recreational equipment.</p>
	<p><u>Description:</u> A publicly accessible open space designed and equipped for active recreation and organized sports. Playing fields and courts may include grass, artificial turf, clay, dirt, stone dust, concrete, asphalt, ice or other pervious or impervious materials to support various sporting organizations and events.</p> <p><u>Design Standards:</u> <u>Size of Space:</u> 7,500 S.F. Min.; 5 Acres Max. <u>Furnishing:</u> Seating: 1 Seat/275 S.F. Min. <u>Landscape:</u> Landscaped Area: 20%</p>
<p>I. Athletic Field or Ball Court (CS, POPS)</p>	
	<p><u>Description:</u> An open space designed for active and passive recreation with features and facilities that support the community or</p>
<p>J. Neighborhood Park (CS, POPS)</p>	

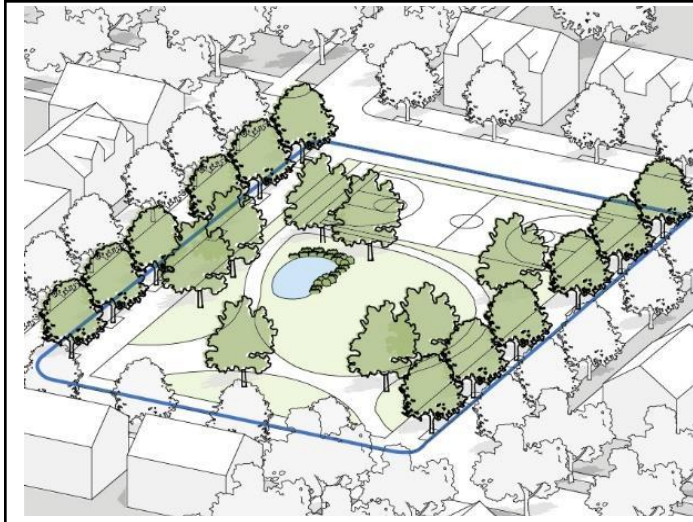

immediate neighborhood. Parks can include other Outdoor Amenity Spaces such as community gardens, recreation fields and courts, trails and pathway, swimming pools and water features, and other facilities intended for public events, gatherings, and organized activities.

Design Standards: Neighborhood Parks should be a minimum of 8,000 S.F.; 80% permeable surfaces; and 1 tree/350 SF on average.

K. Streetside Terrace (POPS)

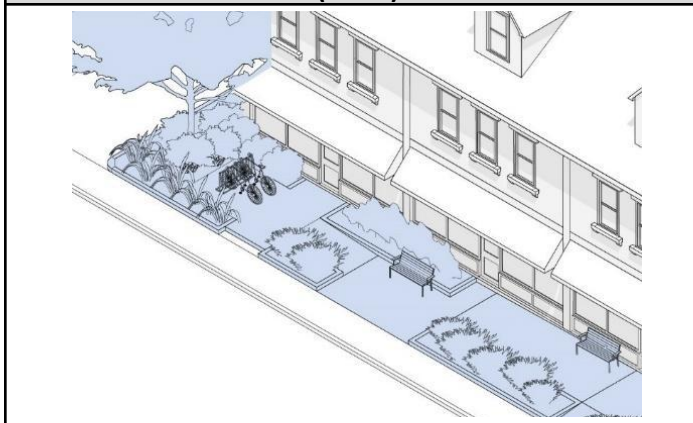

Description: An open space where the building façade is setback from the Street R.O. W. Line and the space between is occupied by a hardscape intended for use as an extension of the public sidewalk and outdoor amenity space such as for outdoor seating or displays. The space may also allow for public circulation along the façade and can be used to provide at-grade access or a grade change along a Street R.O.W. Line.

L. Rooftop Terrace (POPS, PS)

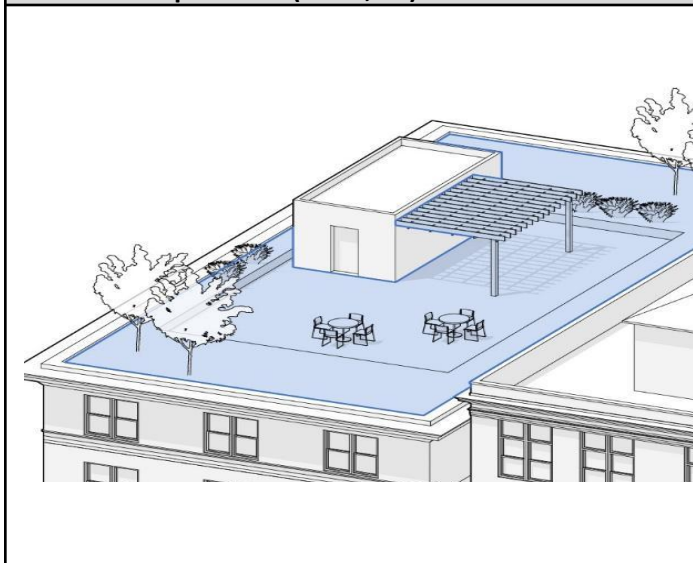

Description: A roofless, raised platform on the roof of a building that provides community gathering space such as a terrace, community garden, food and entertainment, or other outdoor amenities.

Design Standards: Terrace should be setback a minimum of 5 feet from any building wall and secured by a perimeter fence at least 4 feet tall.

M. Pedestrian Passage (CS, POPS)

Description: A paved or brick pedestrian connector between buildings. Pedestrian Passages provide direct connections between parking areas, buildings, streets, and

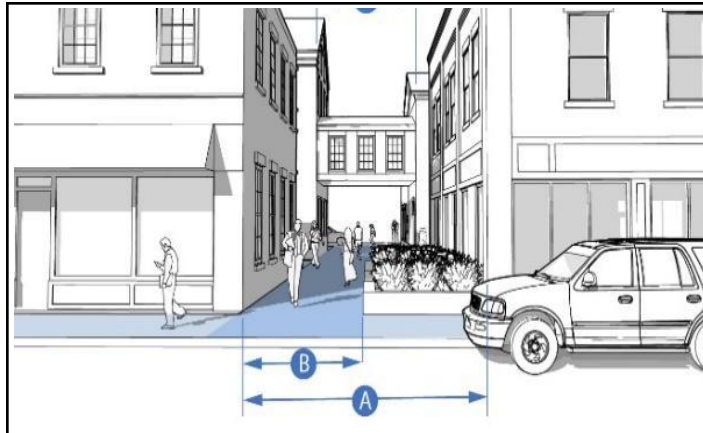

sidewalks. Pedestrian Passages may be covered by a roof, trellis, and may be lined by shopfronts.

Design Standards: The minimum width should be 10 feet (A) with 5 feet of throughway for pedestrians (B); hard surface such as asphalt, concrete, or paver stones is required; lighting is required; landscaping is recommended.

N. Pathway (CS)

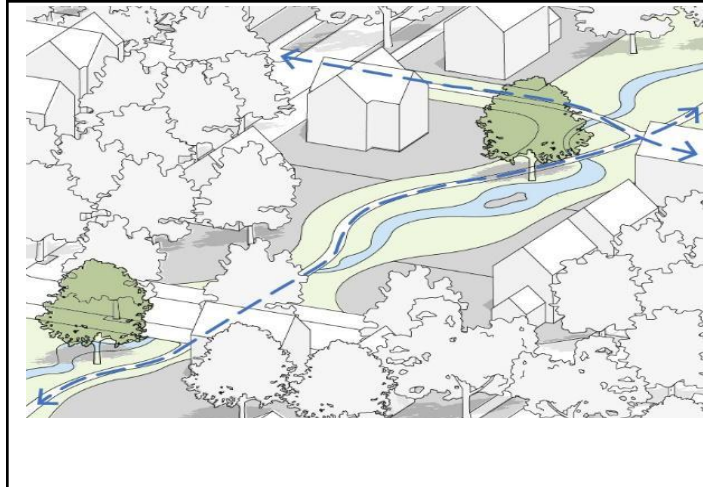

Description: A linear open space that may follow natural corridors providing unstructured and limited amounts of structured recreation. A pathway may be spatially defined by segment and include access to pedestrians, bicyclists, and other designated modes of transportation. Pathways may provide access and connections between natural areas, neighborhoods, villages, public facilities, and other points of interest.

Design Standards: The minimum width should be 8 feet; Pathways shall be surfaced with stone dust, or asphalt.

O. Other Outdoor Amenity Space Types

Permitted by Special Permit by the Planning Board

8.0 COMPLETE STREETS

8.1. INTENT

- A. To encourage “Complete Streets” that accommodate multiple modes of transportation, consistent with Winchendon’s character of traditional neighborhoods and town center, and safe and attractive to pedestrians and bicyclists.
- B. To ensure the development of a well-connected travel network, composed of direct and convenient routes that reinforce Winchendon as a walkable, bikeable, and human-scaled community.

8.2. APPLICATION

- A. **Public Infrastructure Projects.** These standards shall be considered in the design and utilization of new or redesigned public streets.
- B. **Private Participation.** Applicants for site plan approval for a development project, subdivision approval, building permit, or change of use may participate in partnership with the Town of Winchendon on the construction of streetscape improvements planned for public streets including the areas within the right-of-way between the vehicle lane and street line along the applicant’s property frontage. All improvements must be approved by the Board of Selectmen in consultation with the Planning Board and Department of Public Works.

8.3. STANDARDS FOR ALL THOROUGHFARES

- A. **Complete Street Zones and Components.** Figure 8.3.1 below identifies complete street components that are allowed in each segment of public realm zone which includes the public right-of-way and the building frontage area.
- B. **Complete Street Design and Construction Standards.** Public streets must be engineered and constructed in accordance with the Town of Winchendon Subdivision Regulations. In the absence of official standards, Thoroughfares must be designed and constructed according to the standards deemed to be appropriate by the Town Engineer and Planning Board. Figure 8.3.1 below provides design guidelines for new public streets in Winchendon.

FIGURE 8.3.1 - COMPLETE STREET ZONES AND COMPONENTS



STREET COMPONENT	Grey - Vehicle Throughway Zone	5. Street Enhancement Zone	4. Furnishing and Utility Zone	3. Pedestrian Throughway Zone	2. Public Frontage Zone	1. Building Frontage Zone
Motor Vehicle Travel Lanes	●					
Bicycle Facilities	●	●				
Crosswalks	●	●				
On-Street Parking Lanes		●				
Curb-Extensions		●				
Bus Facilities		●	●		●	●
Utilities/Green Infrastructure	●	●	●	●	●	●
Street Trees and Tree Pits		●	●		●	●
Public Seating		●	●		●	●
Bicycle Parking		●	●	●	●	●
Driveway and Alley Crossings		●	●	●	●	●
Sidewalks				●	●	●

8.4. STREET TYPES AND DESIGN ALTERNATIVES

A. Applicability. Figure 8.4.1 below identifies the types of streets and options for design consistent with the Town of Winchendon Subdivision Rules and Regulations. Design and construction standards shall apply as follows:

1. All new streets, whether publicly dedicated or privately held;
2. The reconstruction of elements of the public realm when the public realm has been disturbed by development; or
3. Substantial street reconstruction of a street.

B. Waiver. The Planning Board may waive requirements of a particular street type or apply another type when it finds that applying the requirements of Figure 8.4.1 in a particular instance is either practically infeasible or detrimental to the safety of people who walk or bike and these detrimental effects cannot be mitigated.

FIGURE 8.4.1 - COMPLETE STREET TYPES AND DESIGN OPTIONS			
Street Component	Town Center Street	Neighborhood Street	Access Street
<u>Right-Of-Way (B)</u>	50 Ft. Min.	40 Ft. Min.	24 Ft. Min.
Travel Lane (C-5)	11 Ft. Min.	10 Ft. Min.	10 Ft. Min.
Parking Lane (5)	8 Ft Minimum	1 Side or Informal	N/A
Bike Lanes	Optional/ 5 Ft. Min.	Sharrows/Informal	N/A
Multi-Purpose Path	N/A	N/A	N/A
<u>Sidewalks</u>			
Public Frontage Zone (2)	Optional/ 3 Ft. Min.	N/A	N/A
Throughway Zone (3)	5 Ft. Min.	4 Ft. Min.	1 Side/ 4 Ft. Min.
Furnishing/Utility Zone (4)	5 Ft. Min	4 Ft. Min.	N/A
Street Enhancement Zone (5)	Optional	N/A	N/A

8.5. VEHICLE THROUGHWAY ZONE

A. Design and Construction. A Vehicle Throughway must be designed and constructed in accordance with the Town of Winchendon’s Street and Sidewalk Design Standards and/or the Subdivision Regulations. In the absence of official standards, Thoroughfares must be designed and constructed according to standards deemed to be appropriate by the Town Engineer and Planning Board in accordance with the following standards

B. Travel Lanes.

1. Motor vehicle travel lanes may have a width between ten (10) feet and twelve (12) feet.
2. When two opposing motor vehicle lanes share space as part of a “yield street configuration,” the combined width of the travel lanes may be reduced to a minimum of 16 feet.
3. No more than two (2) motor vehicle travel lanes may be combined for any single direction of traffic flow.
4. Materials must be as following unless otherwise specified by the Department of Public Works.
 - (a) Pavement must be hot mix asphalt.
 - (b) The surface course must be 1.5” deep.
 - (c) The binder course of the pavement must be Geotextile plus 2.5” asphalt.
 - (d) The subbase must be 24” for poor to fair soils and 12” for good to excellent soils.
5. Pervious pavement may be acceptable if planned and implemented in consultation with the Department of Public Works and an engineer who has experience with pervious pavement, and established specifications such as those provided by the University of New Hampshire Stormwater Center Design Specifications for Porous Asphalt Pavements and Infiltration Beds.

C. Bicycle Travel Facilities.

1. Bicycle Travel Facilities may be located in the Vehicle Throughway Zone, or the Street Enhancement Zone. (For example, a separated bike lane may be located between on-street parking and the Furnishing and Utility Zone).
2. Separated Bicycle Lanes must be designed in accordance with the 2015 MassDOT Separated Bike Lane Planning and Design Guide or the latest version.
3. Bicycle throughways (bicycle lanes) may be constructed of hot mix asphalt or porous asphalt. Porous asphalt must be planned and implemented in consultation with the Department of Public Works and an engineer who has experience with pervious pavement, and established specifications such as those provided by the University of New Hampshire Stormwater Center Design Specifications for Porous Asphalt Pavements and Infiltration Beds.

D. Crosswalks.

1. The Continental Crosswalk pattern is preferred by the Town of Winchendon.

2. Crosswalks must be aligned with the pedestrian throughways to which they are connected, unless granted a waiver by the Planning Board by Site Plan Approval.
3. Where an adjacent pedestrian throughway is wider than the prescribed width of the crosswalk, the crosswalk markings should be widened to match the adjacent pedestrian throughway.

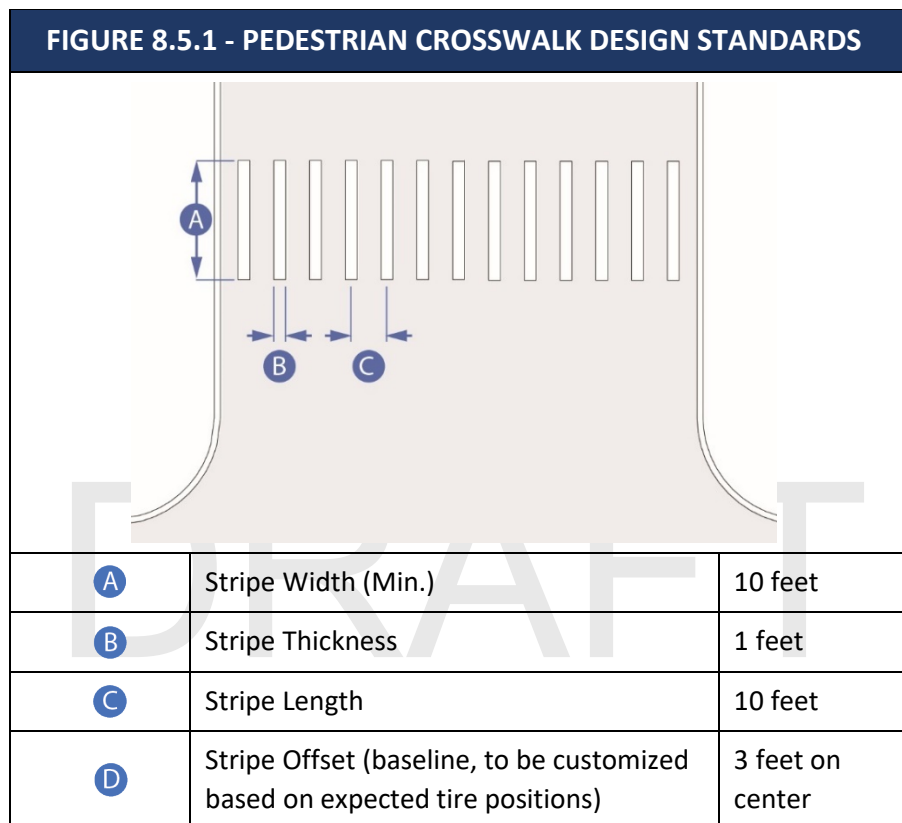

4. Crosswalks must be thermoplastic unless epoxy is approved by the Department of Public Works. The Planning Board may allow flush granite and a mix of materials such as stamped concrete with flush granite to create visual cues and reinforce a specific design character.

8.6. STREET ENHANCEMENT ZONE

A. Overview. The street enhancement zone includes the area between the Furnishing & Utility Zone and the edge of motor vehicle and bicycle travel lanes. Components in this area include temporary activation uses like parklets and food trucks (where allowed – See Section 9 – Public Realm Activation), and permanent components such as on-street parking spaces, stormwater infiltration areas, curb extensions, and crosswalks. The Street Enhancement Zone

can include some of the same elements as the Furnishing & Utility Zone, such as public seating, bike racks, and planting.

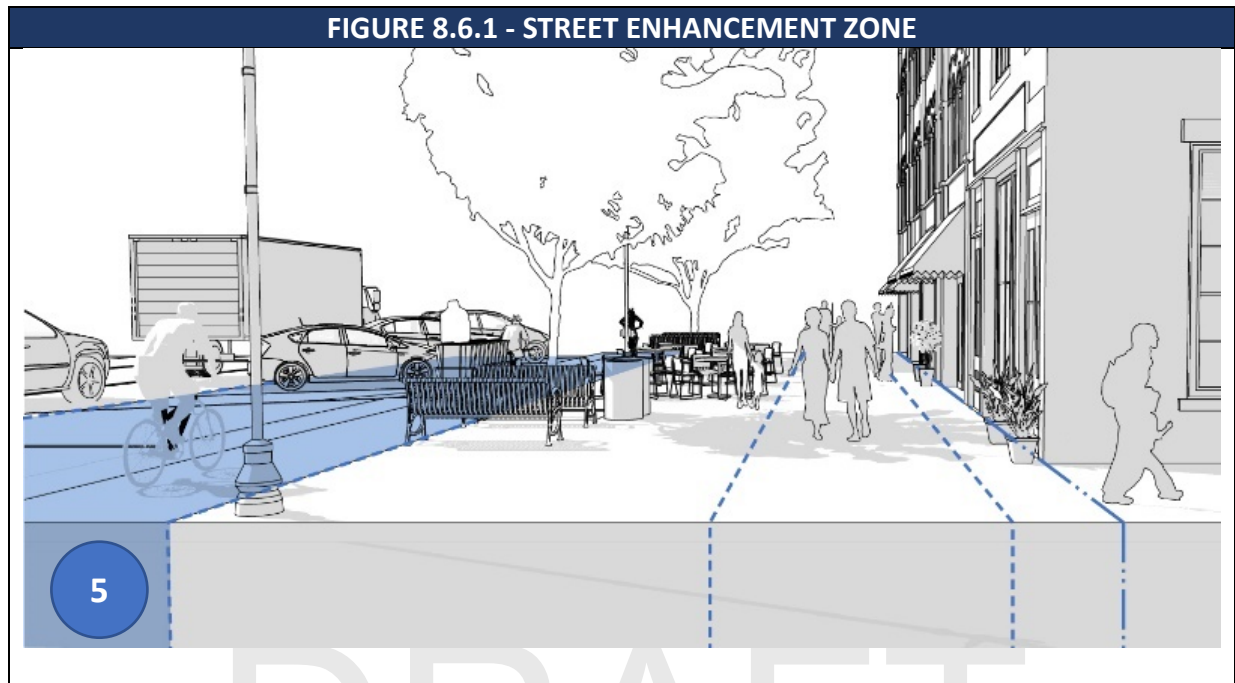

B. On-Street Parking Lanes.

1. Where motor vehicle parking lanes are desired, they must be eight (8) feet wide minimum and twenty-two (22) feet long maximum for parallel parking spaces; and nine (9) feet wide and eighteen (18) feet long for angled parking spaces.
2. Angled on-street parking may be 60° or 90° angle parking. Sixty degree (60°) angle parking may be head-in or reverse-angle parking per the recommendation of the DPW.
3. Gutter seams, drainage inlets, and utility covers must be flush with the pavement surface and oriented to prevent conflicts with bicycle tires.

C. Curb Extensions.

1. A curb extension is required at mid-block crossings and may be required at intersections as deemed necessary by the DPW based on traffic volumes, visibility, accident history, and required vehicle turning radii. A curb extension should only be installed where motor vehicle traffic deflection is provided through on-street parking, a parklet, another curbside use, or pavement markings.

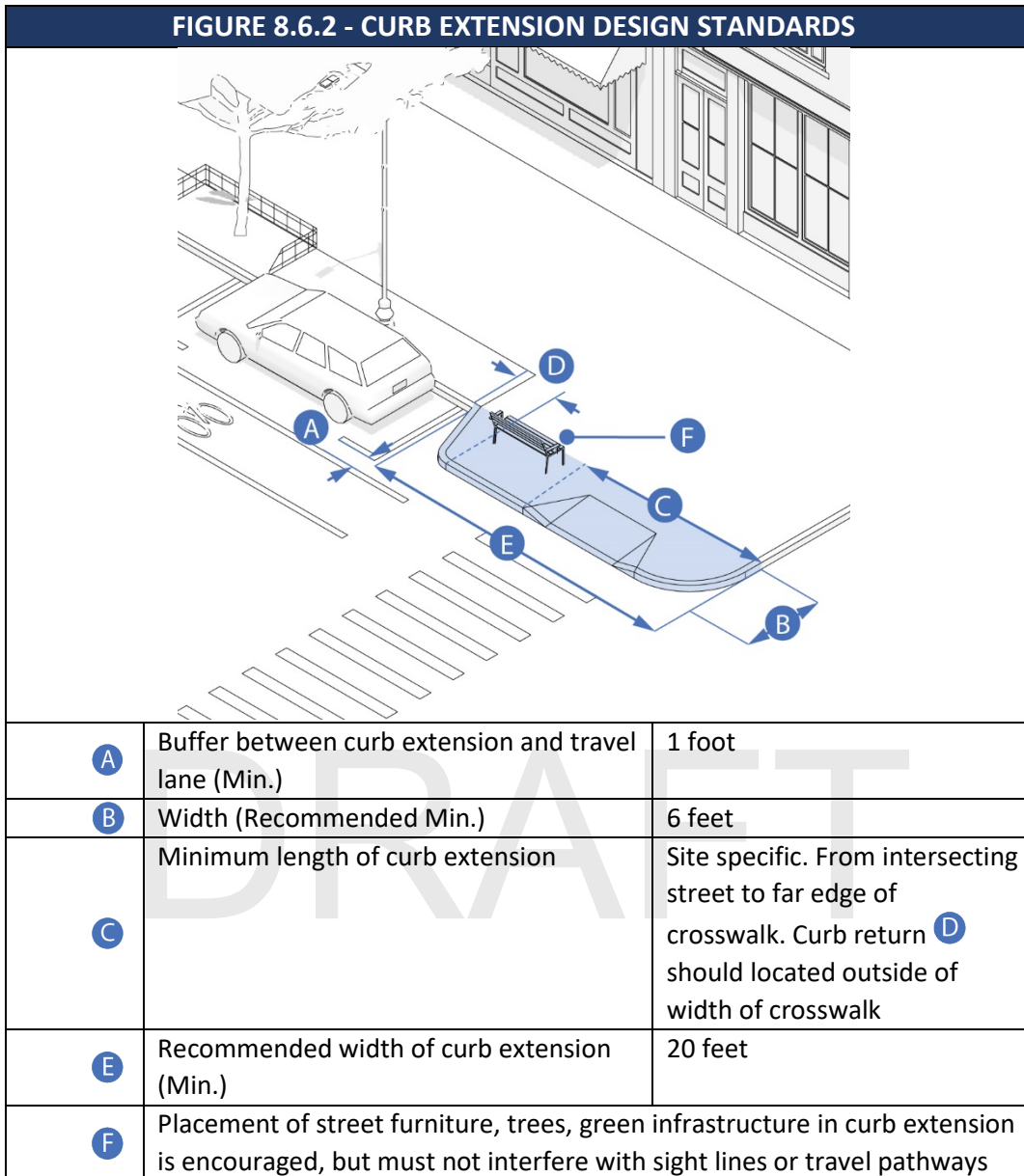

2. A curb extension should occupy as much of the width of the parking lane as is practicable, while providing a minimum of 1 foot between the edge of the curb extension and adjacent motor vehicle or bicycle lanes. The recommended minimum width of a curb extension is 6 feet. When a curb extension includes a streetside gutter adjacent to a bicycle lane, the curb extension must be set back so that the gutter does not extend into the bike lane.
3. A curb extension should be, at a minimum, as long as the width of the adjoining crosswalk with the curb returns from the curb extension located outside of the width of the crosswalk. Where possible, a curb extension should be 20 feet long to restrict parking within 20 feet of an intersection.

4. Where a sidewalk extension includes a bus stop, the design of the sidewalk extension must follow the guidelines for Boarding Bulb Stops found in the latest edition of the NATCO Transit Street Design Guide.
5. Incorporation of street furniture, trees, and/or green infrastructure into curb extensions is encouraged. However, these elements must not interfere with pedestrian flow, emergency access, or visibility between pedestrians and other roadway users.

D. Bus Facilities.

1. Where bus stops exist, site design and ancillary improvements to the public realm should ensure:
 - a) Adequate sight lines for bus stop signage,
 - b) Minimization of circulation conflicts between bus stops users and vehicles or pedestrians using the adjacent public realm or site,
 - c) Attractive surroundings and amenities for bus riders, including where appropriate covered bus shelters with illumination and adequate seating for anticipated riders, bicycle racks, and information kiosks.
2. Bus Pullout design should be consistent with the guidelines found in the latest edition of the NATCO Transit Street Design Guide. The “Curbside Pull-Out Stop” is the preferred bus stop type in the Town, except when the DPW and Planning Board find another bus stop type is preferable.

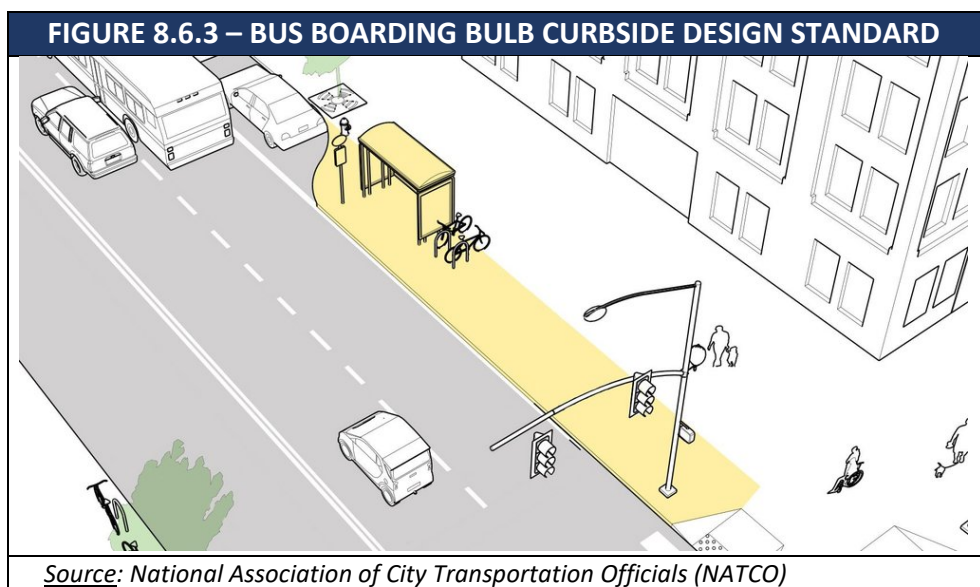

E. Utilities.

1. The design and construction of all water and sewer utilities, stormwater management infrastructure, public lighting, and public furniture is subject to review and approval by relevant Town departments and/or adopted standards by the Planning Board and/or Department of Public Works.
2. All new electrical, communications, and cable utilities must be located underground.

F. Green Infrastructure.

1. Green Infrastructure is encouraged wherever possible, subject to the standards found in **Section XX of the Zoning Bylaw/Subdivision Regulations.**

8.7. FURNISHING & UTILITY ZONE

A. Overview. The Furnishing & Utility Zone is the area of the sidewalk where pedestrians might pause or rest on benches or cafe seating and where many of the utilities, like lighting and hydrants, are located. This is the area typically planted with street trees. The Furnishing & Utility Zone varies in width.

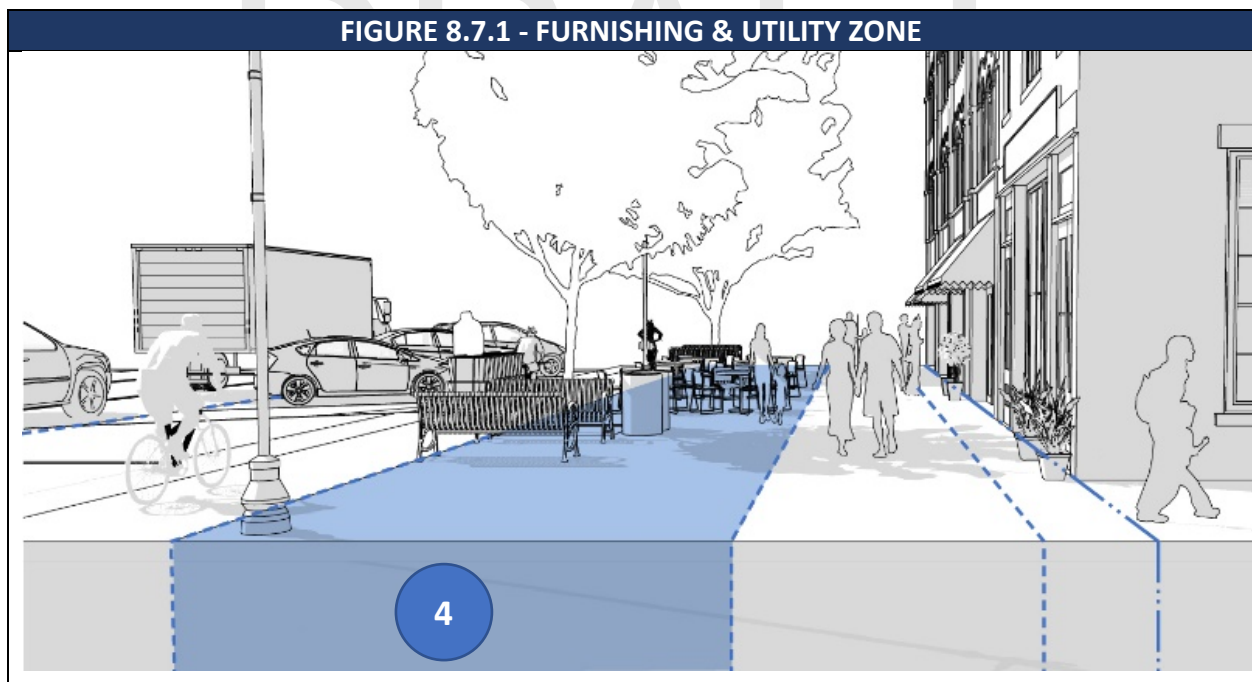

B. Width. The required width of the Furnishing & Utility Zone is determined by street type. See Section 8.4 above.

C. Surfacing. Unless otherwise specified in these regulations or in specifications adopted by

DPW, the Furnishing & Utility Zone must be surfaced with concrete and edged with a granite curb on the streetside. Pervious concrete unit paving, per the specifications of the DPW, may be used over areas contributing to street tree minimum recommended soil volumes (see Street Tree and Tree Pit Standards).

D. Street Trees and Tree Pits.

1. Installation Requirements.

- a) New street trees should be planted within the Furnishing & Utility Zone to fill any gaps greater than 50 feet long between existing street trees. The Planning Board may grant a waiver from this requirement based on numbers 4, 5, 6, or 7 below.
- b) Street trees should be planted in a regularly spaced pattern with trees aligned parallel to the curb. Trees should generally be spaced twenty to thirty (20 - 30) feet on center depending on species, and no greater than forty (40) feet on center.
- c) When trees are planted both in the Furnishing & Utility Zone and in Public Frontage Zone or the Building Frontage Zone, the trees on either side of the Pedestrian Throughway should be aligned in an allee pattern, when possible.
- d) Spacing of trees planted in the Furnishing & Utility Zone or Building Frontage Zone may be adjusted to avoid obscuring windows, doors, and signage.
- e) A tree must not be planted in a location where it will block passage to a doorway or stairs, or where it will narrow a Throughway to less than the minimum dimensions required by this ordinance.
- f) The Planning Board may, at its discretion, grant a waiver from street tree requirements when the tree would obstruct a terminated vista or when a tree would obstruct views to or into a civic space.
- g) Street Trees must be planted at least five (5) feet from fire hydrants, six (6) feet from street signs, seven (7) feet from curb cuts, and thirty (30) feet from stop signs. The edges of tree planting beds must be at least two (2) feet from gas, electric, water, and sewer lines, and at least four (4) feet from oil fill pipes.
- h) A tree pit must be a minimum of five (5) feet wide (dimension perpendicular to curb) and ten (10) feet long (dimension along curb). The Planning Board may grant a waiver from these specific dimensions, if this configuration is not possible due to site constraints, and an alternate configuration that amounts to a minimum of 50 square feet of surface is provided.
- i) A tree should be planted generally in the center of its surrounding soil area.

- j) The soil area around a street tree must be protected from compaction due to foot traffic. When the adjacent throughway is five (5) feet or wider, a tree guard (a metal fence at least 18 inches tall), must be installed around three sides of the tree (the curbside remains unfenced). When the adjacent throughway is less than five (5) feet wide, the soil area around a street tree must be protected by porous rubber tree pit surfacing. To prevent tripping hazards, the finished grade of the porous rubber tree pit surfacing must be level with the grade of the surrounding pavement.
- k) A gap of approximately eight (8) inches must be left between any mulch or porous rubber tree pit surfacing and the trunk of the tree to avoid mounding above the trunk flare.
- l) When planted, street trees must be a minimum height of ten (10) feet and/or two and one half (2.5) inches in caliper.

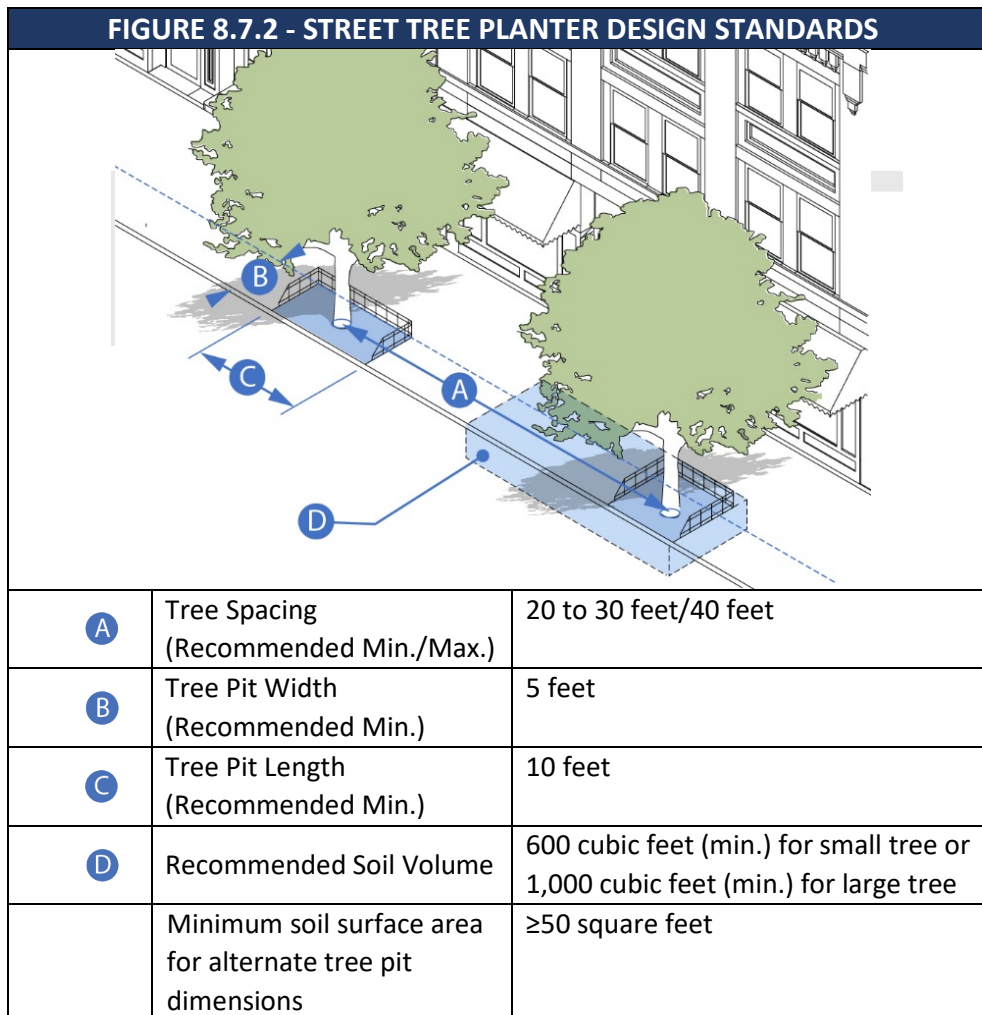

2. Recommended Techniques for Achieving Adequate Soil Volume. Urban soils beneath sidewalks are often compacted and deprived of water and nutrients, significantly compromising tree health, stability, and lifespan. When those conditions exist, the following techniques are strongly encouraged:
- The use of a modular suspended paving system, like Silva Cells, beneath the surrounding concrete sidewalk. The structural units in these systems are designed to bear the load of the concrete surface above, while providing void space which is filled with planting soil. Besides offering an environment for a tree's roots to grow, the more loosely compacted soil in these systems also offers bioretention of stormwater, which enters the system through permeable paving or through the tree pit.
 - Adjacent tree pits' soil volumes should be connected as a continuous trench, paved with permeable pavers or porous rubber surfacing.
 - Structural soil is not a substitute for modular suspended paving systems. The space for planting soil within structural soil is limited to the void spaces among the aggregate (only about 20% total). This is significantly less than the soil volume in a modular suspended paving system. Therefore, structural soil, while less expensive per cubic foot, ultimately restricts tree growth and health compared to a modular suspended paving system and so it should only be used as a supplement (around the backs and edges).

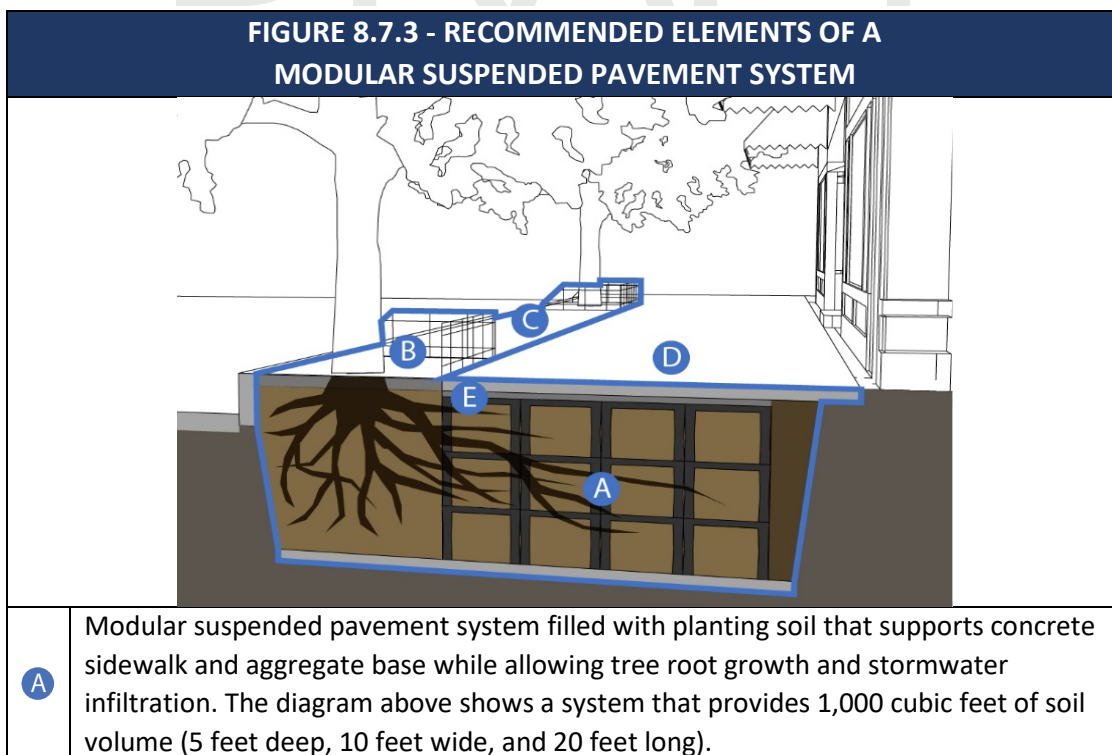

B	Soil pit protected by tree guard fencing or permeable rubber mulch walking surface.
C	Permeable paving strip, over modular suspended pavement system
D	Concrete sidewalk and aggregate base
E	Edge restraint between aggregate base and tree pit opening

E. Public Seating. (Also applies to Street Enhancement Zone, Furnishing & Utility Zone, Public Frontage Zone, and Building Frontage Zone).

1. Public seating is an essential component of Winchendon's public realm. It should be provided whenever possible. Public seating can take a variety of shapes including chairs, benches, seating walls, or low tables.



2. Any seating within the Street Enhancement Zone (e.g. in a curb extension), the Furnishing & Utility Zone, or the Public Frontage Zone will be considered public seating. Public seating must be available for public use and must comply with the standards in this section.
3. Providing public access to seating in the Building Frontage Zone is encouraged. Seating in the Building Frontage Zone must comply with the standards in this section.
4. Public seating must be sited according to the following design standards:
 - a) Public seating must not be placed where it would narrow the Pedestrian Throughway below the required minimum width;
 - b) Public seating must not be placed where it would obstruct access to a building entrance or exit;
 - c) Public seating must not be placed where it would obstruct access to bicycle parking, informational kiosks, fire hydrants, trash receptacles, or other street furniture;
 - d) Public seating must be permanently affixed to the ground. Moveable furniture may be acceptable within the public realm if a responsible party agrees to maintain the

moveable furniture in good working order, remove it at night and during snow emergencies, and replace it as necessary.

e) The following ADA clear widths must be maintained when installing public seating:

- 1) Three (3) feet minimum on either side of the seating;
- 2) Five (5) feet minimum from fire hydrants; and
- 3) One (1) foot minimum from any other amenity, utility, or fixture.

5. Public seating should be sited according to the following design guidelines:

- a) Site benches to provide views, preferably of people walking by;
- b) Provide seating in a variety of micro-climates. Locate some seating where there is summer shade, preferably from street trees. Locate other seating where it will be warmed by winter sun, especially adjacent to surfaces that will hold that heat, like stone or brick walls;
- c) Maintain adequately spaced pathways from parked cars and loading zones.
- d) Where possible, provide one (1) foot between the front of the bench and any Throughway so that the legs of people sitting on the bench do not obstruct the Throughway;
- e) Where the back of the seat abuts a building, wall, or other obstruction, a 1 foot minimum clear width should be provided for maintenance and trash removal.

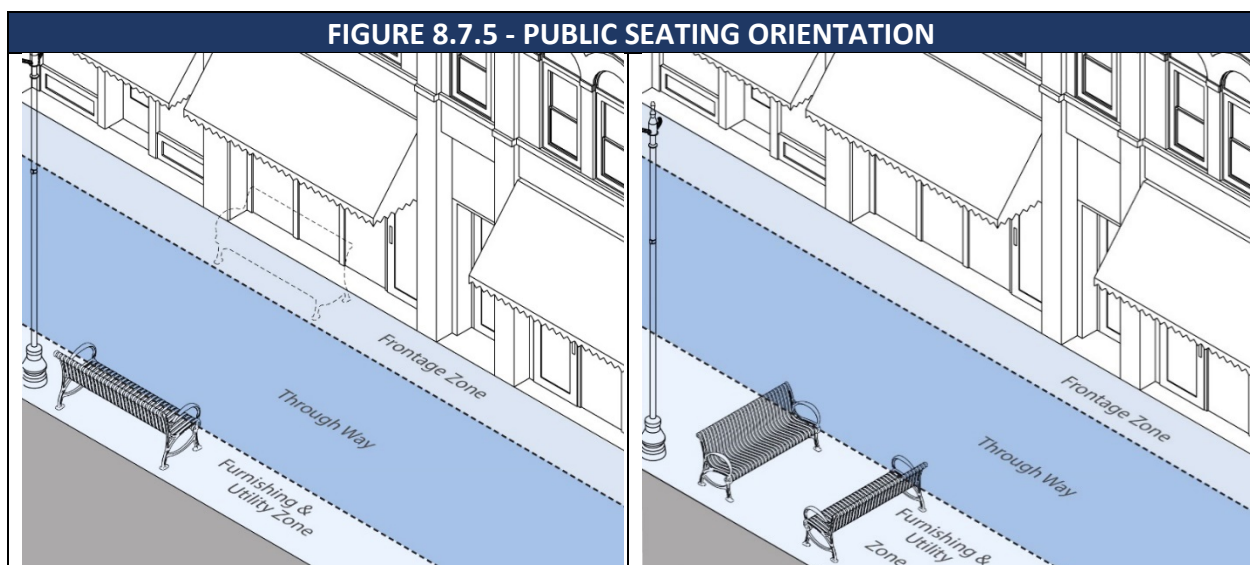

6. Public seating should generally be oriented so that it faces the nearest Throughway zone. When two or more seats will be arranged facing each other, the benches may be oriented

perpendicular to the Throughway Zone. When public seating is adjacent to a bus stop, it should face the bus stop, and be located to the right of the front door loading zone.

7. Seating should be provided both with and without armrests if possible. Armrests provide stability for those who require assistance sitting and standing. Seating without armrests allows a person in a wheelchair to maneuver adjacent to seating or to slide onto it easily. Seating areas longer than 4 feet should provide armrests or other dividers to discourage reclining.

F. Bicycle Parking. (Also applies to Street Enhancement Zone, Furnishing & Utility Zone, Public Frontage Zone, and Building Frontage Zone).

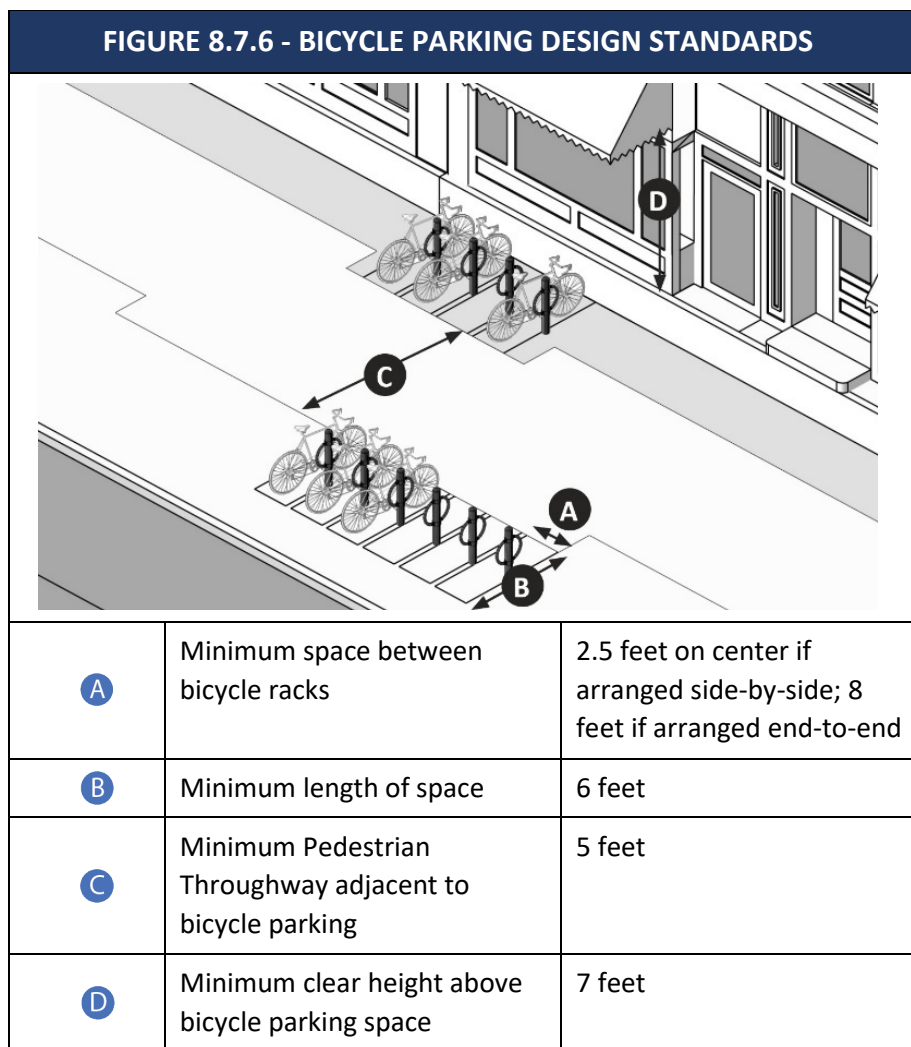

1. The following list sets out the Town’s preferred locations for bicycle parking from most preferred location to least preferred location: the Furnishing & Utility Zone, the Street

Enhancement Zone, the Public Frontage Zone, the Building Frontage Zone, beside a building, behind a building.

2. Installation of a bicycle rack within the public realm requires Town approval from the Board of Selectmen.

G. Driveway and Alley Crossings.

1. A driveway or alley that crosses a paved Furnishing & Utility Zone must be designed to maintain the grade and clear width of the adjacent Pedestrian Throughway and must include sloped flares on both sides of the driveway apron.
2. A driveway or alley that crosses a continuously planted Furnishing & Utility Zone must be designed to maintain the grade and clear width of the adjacent Pedestrian Throughway and must include returned curbs.

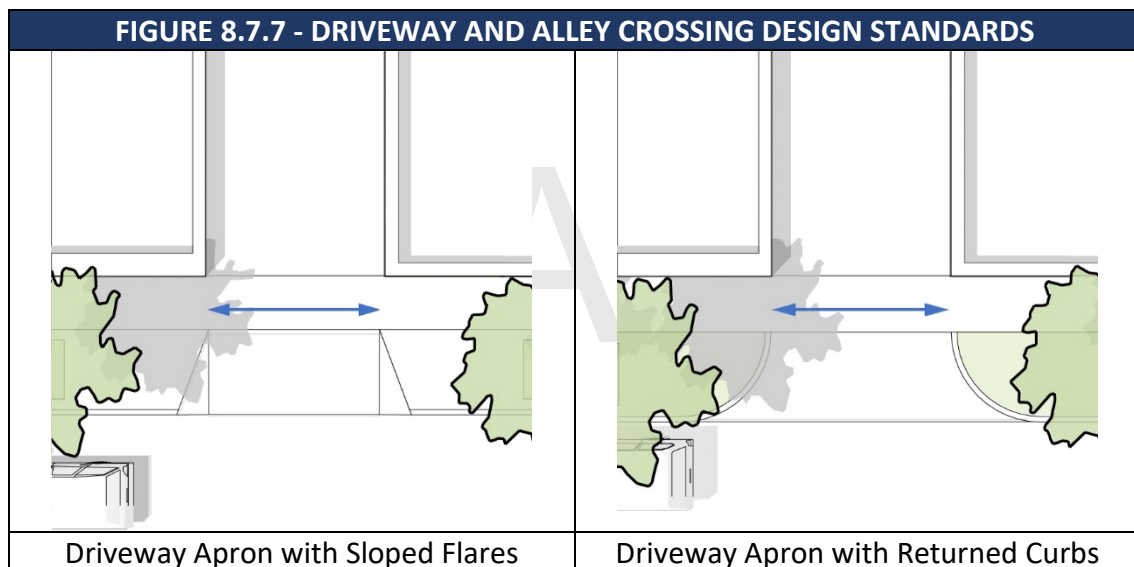

3. The appearance of any walkway (i.e. scoring pattern or special paving) must be maintained across any driveway or alley to indicate that, although a vehicle may cross, the area traversed by a vehicle remains part of the sidewalk.
4. A curb cut may be no wider than the driveway or vehicular entrance it serves, excluding flares or returned curbs. Additional curb cut standards may be established for individual zoning districts.
5. Shared driveways are permitted and encouraged.

8.8. PEDESTRIAN THROUGHWAY ZONE

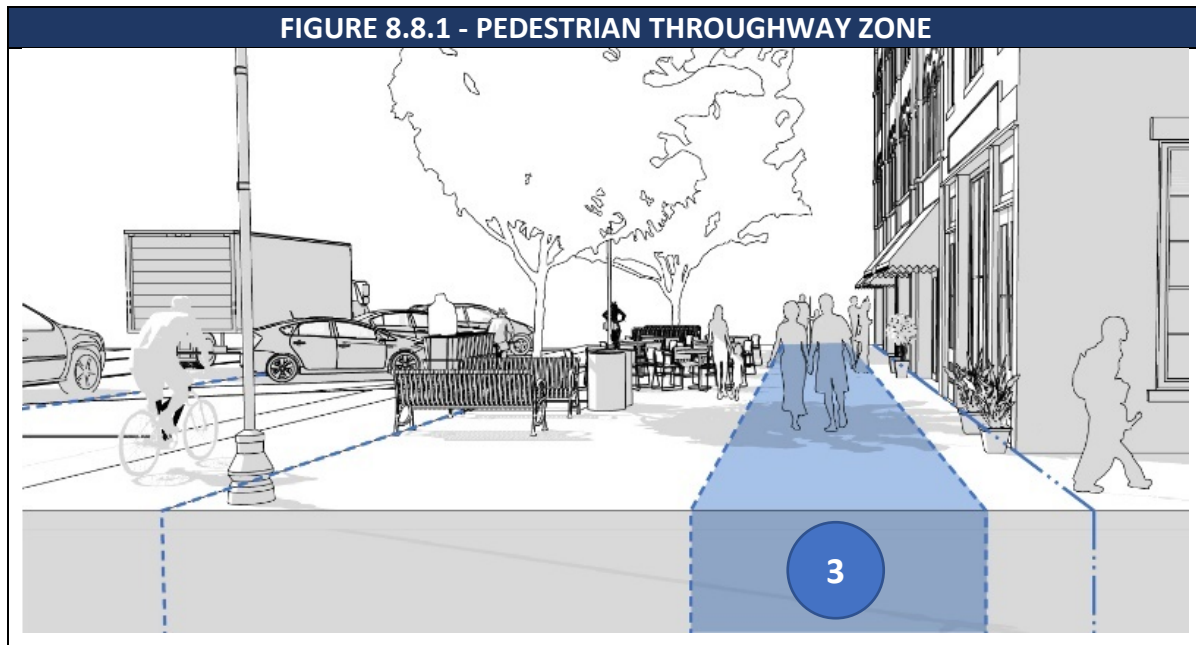

- A. Description.** The Pedestrian Throughway Zone is also known as the sidewalk. It is the primary portion of the sidewalk used for active movement and travel by pedestrians. The Pedestrian Throughway Zone must be an adequate width for comfortable two-way pedestrian movement, must remain clear of obstacles, and its paving surface must be relatively level.
- B. Width.** The required width of the Pedestrian Throughway Zone must be in accordance with the appropriate Street Type found in Section 8.4.
- C. Accessibility.** All new and reconstructed sidewalks must be accessible to and usable by persons with disabilities in accordance with the Americans with Disabilities Act and the Rules and Regulations of the Massachusetts Access Board (521 CMR), as amended.
- D. Construction.** Pedestrian Throughways (sidewalks) must be constructed of cement concrete that is 4 inches deep. Where a driveway crosses a sidewalk, the sidewalk's cement concrete must be 6 inches deep.
- E. Pavement.** The pavement design of Pedestrian Throughways must be continuous for the full length of each block face.

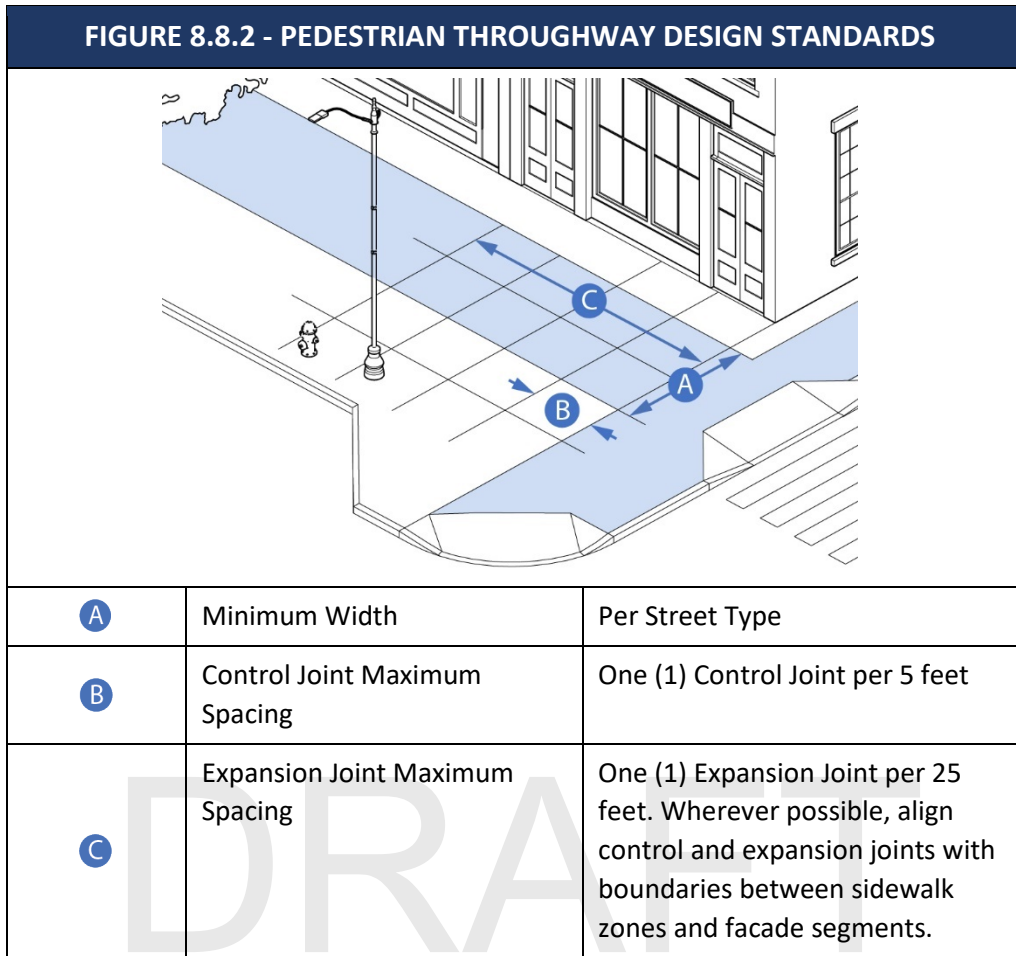

8.9. PUBLIC FRONTAGE ZONE

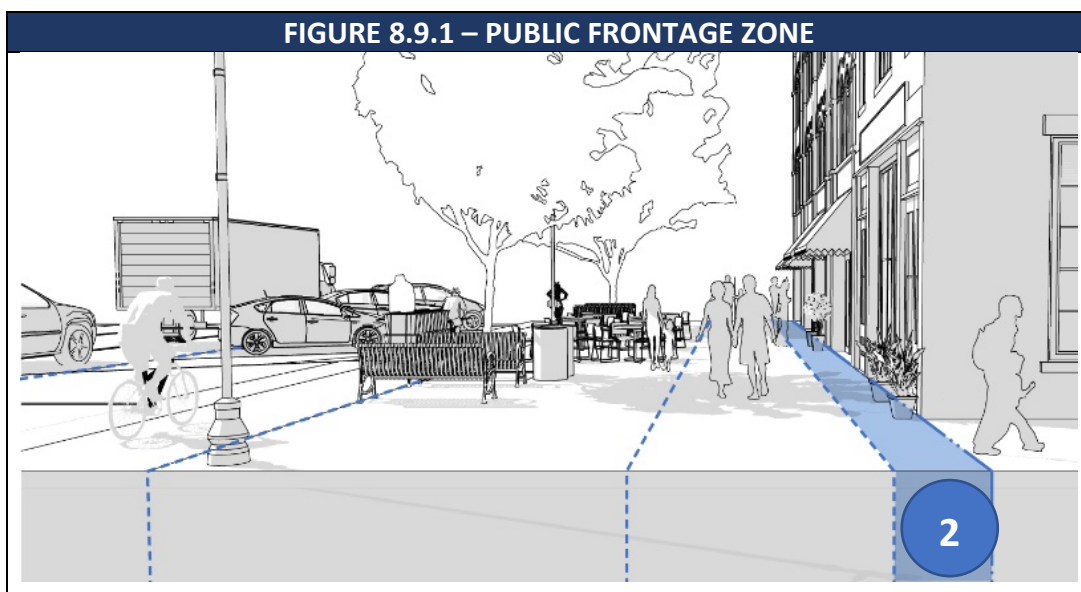

- A. Description.** The Public Frontage Zone is the area between the Pedestrian Throughway and the front lot line. The size and character of the Public Frontage Zone varies widely depending on context. On narrow streets, the Public Frontage Zone may be absent. On wide streets, the Public Frontage Zone provides a transitional space for people who are entering or exiting a building or pausing to read a menu or peer through a shop window. The materials and design of the Public Frontage Zone is often indistinguishable from the Pedestrian Throughway or the Lot Frontage Zone. The zones differ in their functions and the public realm components they can accommodate.
- B. Utilization of the Public Frontage Zone.** See Section 9.0 - Public Realm Activation

DRAFT

9.0 PUBLIC REALM ACTIVATION

9.1. INTENT

The intent of this section is to ensure pedestrian safety and comfort, promote economic vitality, preserve and enhance the character of the public realm along public streets, facilitate social activity and health benefits by providing walkable centers, neighborhoods and districts. The intent to facilitate a variety of activation forms to fulfill the potential of the “Outdoor Room” along Winchendon’s commercial and mixed use corridors.

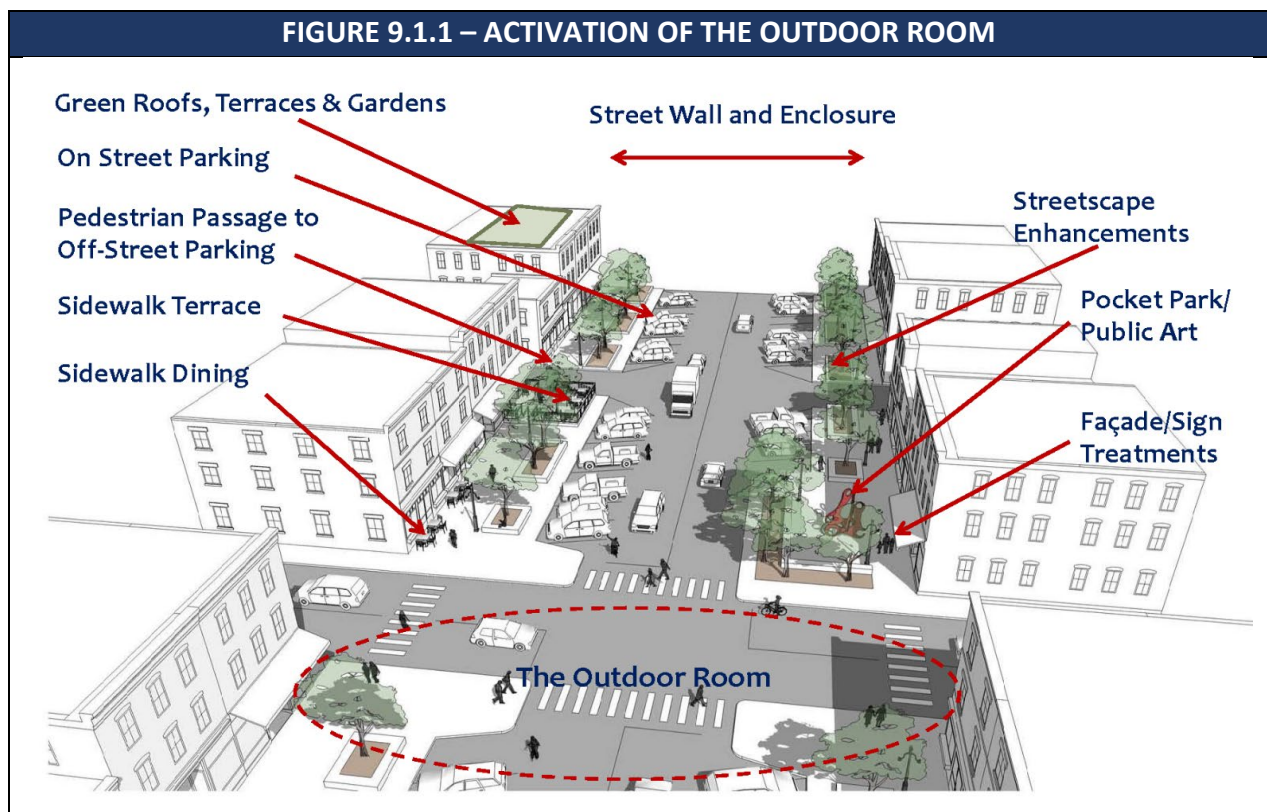

9.2. APPLICATION

- A. Public Realm Activation Components.** The allowed type and location of public realm activation components are listed in Figure 9.2.1 below.
- B. Activation Permits.** Activation permits may be approved by the Board of Selectmen for activation of a public street right of way under the allowed applications in this section. Applicants may include business owners with storefronts along the public right-of-way (with permission from the property owners), or operators of food trucks, pop-up stores, or similar types of activation.

FIGURE 9.2.1 - PUBLIC REALM ACTIVATION COMPONENTS



ACTIVATION COMPONENT	C. Vehicle Throughway Zone	5. Street Enhancement Zone	4. Furnishing and Utility Zone	3. Pedestrian Throughway Zone	2. Public Frontage Zone	1. Building Lot Frontage Zone (See Public Realm Stds)
Parklets		●				
Tactical Urbanism	●	●	●	●	●	●
Landmarks and Public Art		●	●		●	●
Café Seating			●		●	●
Storefront Displays and Chef Stations					●	●
Building Frontage Treatments						●
Building Facade Treatments						●
Building Encroachments						●

9.3. PUBLIC FRONTAGE ZONE

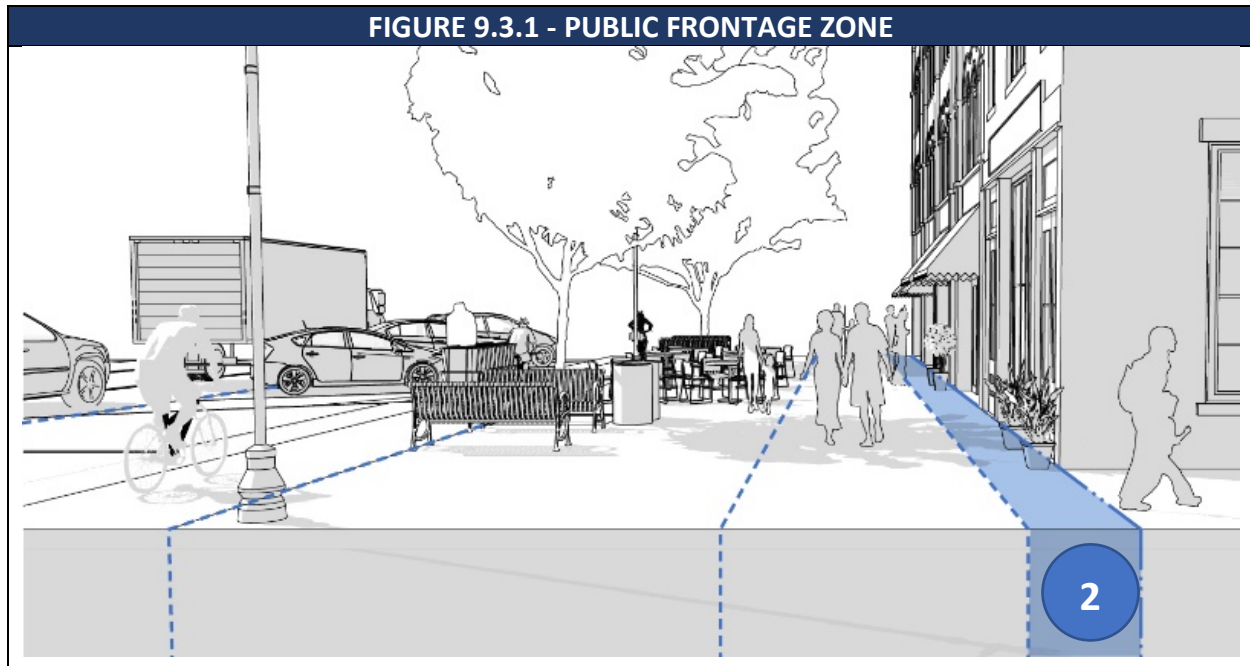

A. Description. The Public Frontage Zone is the area between the Pedestrian Throughway and the front building lot line. The size and character of the Public Frontage Zone varies widely depending on context. On narrow streets, the Public Frontage Zone may be absent. On wide streets, the Public Frontage Zone provides a transitional space for people who are entering or exiting a building or pausing to read a menu or peer through a shop window. The materials and design of the Public Frontage Zone is often indistinguishable from the Pedestrian Throughway or the Building Frontage Zone. The zones differ in their functions and the public realm components they can accommodate.

B. General Standards.

1. **Width.** The required width of the Public Frontage Zone must be in accordance with the appropriate Street Type found in Section 8.0 – Complete Streets.
2. **Materials and Construction.** Unless otherwise specified by the Department of Public Works, the materials and construction of the Public Frontage Zone should match, and be indistinguishable from, the Pedestrian Throughway.
3. **Other Standards.** Unless otherwise specified by standards provided by the Department of Public Works.

C. Outdoor Café Seating. (Also applies to Street Enhancement Zone, Furnishing & Utility Zone and Building Frontage Zone)

1. General Requirements.

- a) Outdoor cafe seating is permitted as an ancillary activity of any Eating & Drinking Establishment.
- b) The operator of the outdoor cafe seating is responsible for the proper maintenance of the cafe area at all times, including proper disposal of all trash generated.
- c) Outdoor Seating may be located in the Building Frontage Zone, Public Frontage Zone, Furnishing & Utility Zone, or Street Enhancement Zone
- d) Outdoor café seating within the Public Realm must receive an **Encroachment Permit** from the Board of Selectmen.
- e) Outdoor café seating must be located within the street frontage of the establishment it serves, and/or to the side or rear of the establishment it serves.

2. Design Standards for Outdoor Café Seating.

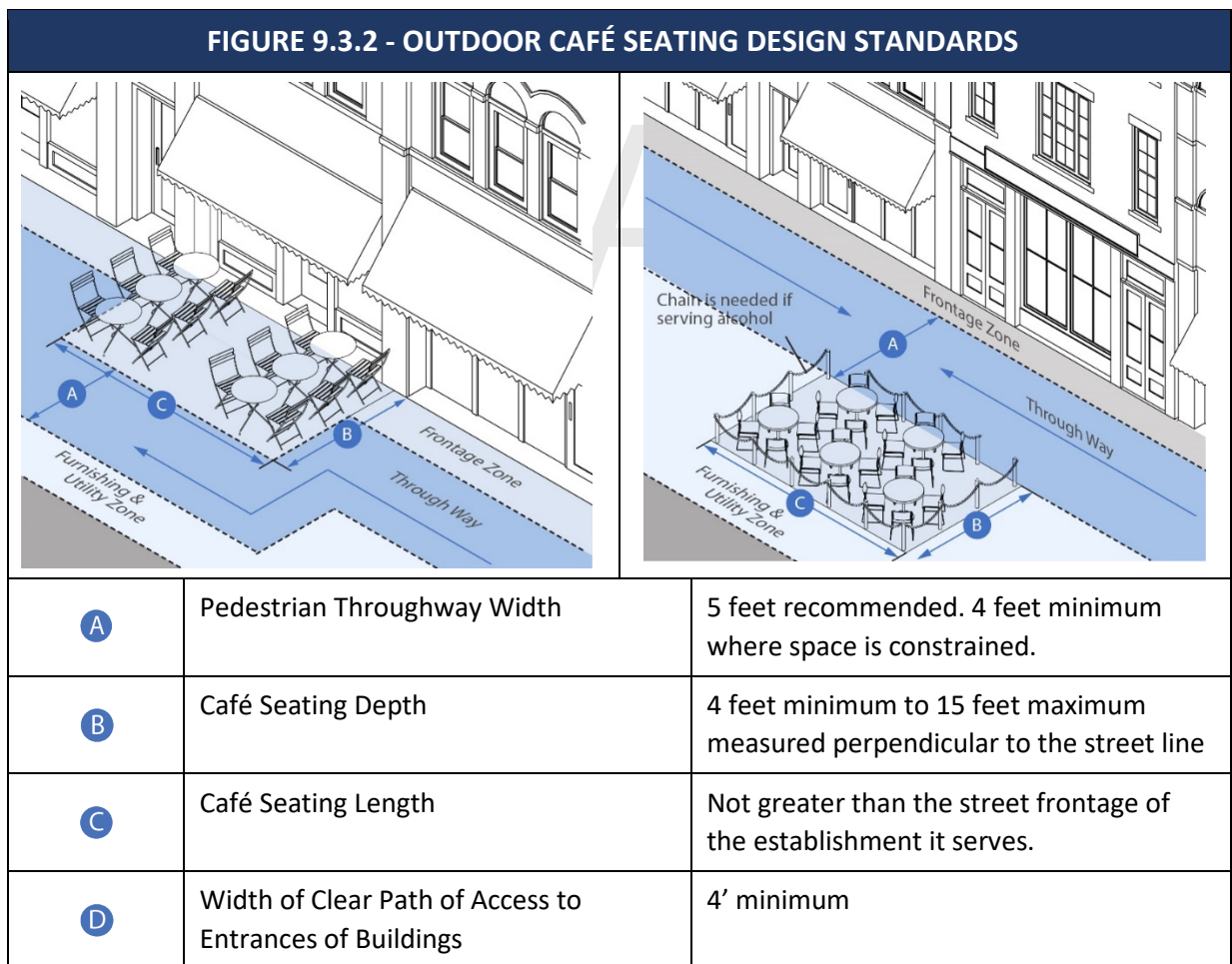

3. Furniture.

- a) Furnishings may only consist of moveable tables, moveable chairs, moveable umbrellas, required enclosures, and portable or mounted heaters.
- b) All furnishing must be commercial grade and manufactured for outdoor use of safe, sturdy, and durable materials, such as wood, steel, or wrought iron.
- c) When not intended for use during the winter months, outdoor cafe furnishings must be removed and stored indoors.
- d) Tables and chairs for each establishment must match in material and style.
- e) Tables larger than three (3) feet six (6) inches in width or diameter are not permitted.
- f) Standing or stooled table ledges, if provided, must be eighteen (18) inches in depth.
- g) Heaters are encouraged to extend the use of outdoor cafe seating during colder weather. The following standards apply:
 - 1) Heating fixtures require approval by the Fire Department.
 - 2) Heaters may be freestanding or mounted to the underside of an awning.
 - 3) Portable heaters must be stored indoors when the business is closed.
- h) Host stands should complement the chairs and tables in material and style.

4. Weather Protection.

- a) Awnings or individual table umbrellas are encouraged to provide protection from the weather.
- b) Awnings must be secured to a storefront or other exterior wall of a building.
- c) Awnings and umbrellas should be canvas or other non-vinyl material.
- d) Awnings and umbrellas should provide shade for at least fifty percent (50%) of the outdoor cafe seating when provided.

5. Waivers. When outdoor café seating is located to the side of or behind the establishment it serves, the Planning Board may waive requirements of this section.



D. Outdoor Retail Displays.

1. Purpose. Outdoor retail displays located within the public realm can increase the visibility and viability of businesses and can enhance the walkability of an area.
2. Standards. The placement for display and sale of merchandise within the Lot Frontage Area or the Public Frontage Area adjacent to a retail business may be allowed without an Encroachment Permit under the following standards:
 - a) An outdoor retail display is prohibited at any time the use of the associated establishment is not open for business and is prohibited between the hours of 11 p.m. and 7 a.m..
 - b) An outdoor retail display may not obstruct pedestrian or vehicular traffic or be in located in a required corner visibility triangle.
 - c) An outdoor retail display must be located at least two (2) feet outside of the required width of a Pedestrian Throughway Zone.

- d) Unobstructed passage must be provided to building entrances. The passage must be 4' wide minimum with an additional 2' buffer where an outdoor retail display abuts the passage.
- e) Outdoor retail displays must be located at least 2' from any fire hydrant, street furnishing, street tree, or other fixture, and must not infringe upon any area required for the operation of bicycle parking;
- f) Furniture and equipment must not be anchored to a ground surface within the right-of-way nor be attached or affixed to any tree, post, sign or other structure;
- g) A sidewalk retail display area must not exceed 100 square feet for all outdoor displays areas associated with a use; and
- h) Merchandise and display fixtures must not exceed five (5) feet in height and four (4) feet in depth (measured perpendicular to the street line).

FIGURE 9.3.4 – OUTDOOR RETAIL DISPLAYS



E. Storefront Window Displays and Signage. Storefront display windows that display products or services, signs with the name of the business, logos, hours, public service messages or displays, or views to an activity in which people are involved frequently during hours of operation are encouraged. General storefront window display guidelines are as follows:

1. Reflective or dark tinted glass, or reflective films should be avoided.
2. Incorporating a glazed transom above the door is encouraged when storefront heights are sufficient to allow for it.
3. Transparent storefronts are not necessary for some businesses, such as professional offices. Nevertheless, it is preferable to maintain substantial storefront glazing and provide attractive window treatments to avoid blank facades along the sidewalk.
4. Items should not be placed in storefront windows that block views to internal activity, such as the backs of display cases, unless they are part of a display to the outside sidewalk or street.
5. Storefront lighting should be confined to highlighting signage and the window display itself. Lighting that attracts attention to itself should be avoided.

9.4. STREET ENHANCEMENT ZONE

The Street Enhancement zone includes on-street parking and potential pedestrian activity areas between the Furnishing & Utility zone and the edge of street and bicycle travel lanes. Components in this area include temporary uses such as a food truck, which take over parking spaces, and permanent components like stormwater infiltration areas, bike racks and corrals, curb extensions, and crosswalks.

A. Parklets.

1. A parklet is a public space treatment where pedestrian-oriented amenities are placed within the street enhancement zone.
2. A parklet provides Outdoor Amenity Spaces to the general public or an adjacent building use. A parklet is typically installed where additional outdoor amenities are desirable to enhance the pedestrian environment, but sufficient space is not available within the Furnishing and Utility Zone, Public Frontage Zone or Lot Frontage Zone.
3. A parklet is typically installed where there is an on-street parking lane. A parklet may be installed where there is not an on-street parking lane at the discretion of the permit granting authority, provided the parklet will not cause a hazard to travel.

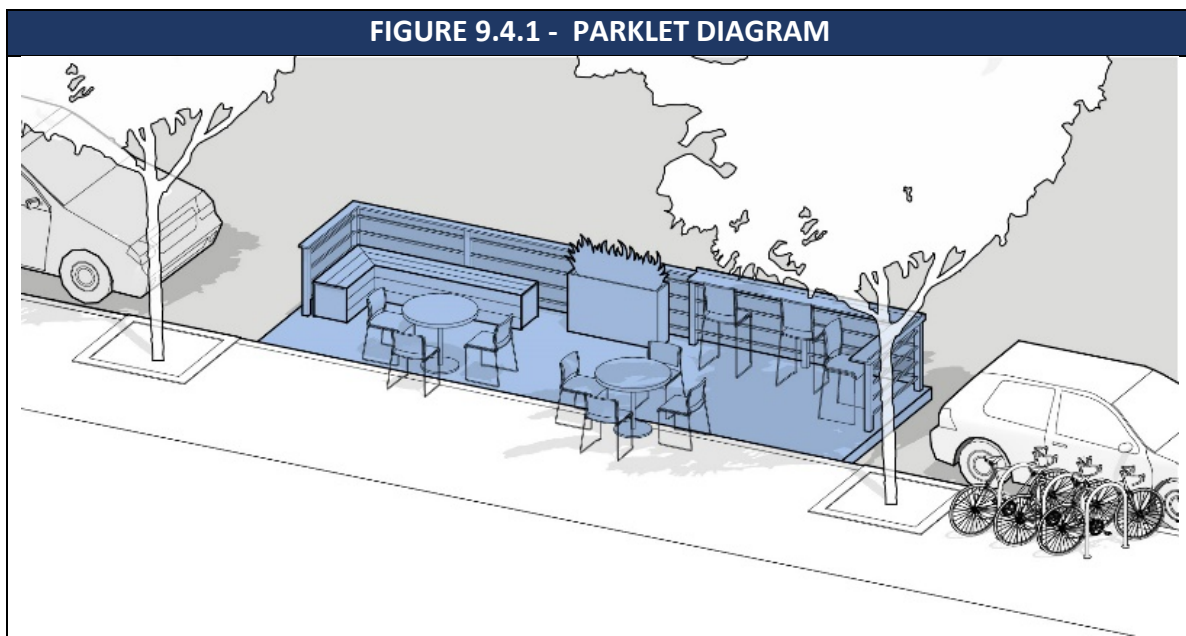

4. Design Standards.

- a) A parklet may be used for public pedestrian-oriented amenities including, but not limited to seating, bicycle parking, planters, or exercise stations.
- b) Use of a parklet for food service, a pop-up store or other temporary retail use may be allowed by site plan approval when it is located within the frontage of a similar adjacent permitted use.
- c) Use of a parklet for food service, a pop-up store or other retail use may be allowed by special permit when the use is not associated with an adjacent permitted use.
- d) A parklet must extend out from the sidewalk flush with the level of the curb.

- e) A parklet should be a minimum of 6 feet wide. It may occupy the full width of the parking lane it extends into or be set back from a motor vehicle lane or bicycle lane by a 1 foot buffer, at the discretion of the permit granting authority.
- f) A parklet must be setback at least fifty (50) feet from the corner of a street.
- g) A parklet must have a sufficient barrier at its street edge to ensure that pedestrians will not cross from the parklet into adjacent travel lanes.
- h) The Town may adopt specific design standards and guidelines for parklets.
- i) If a parklet is proposed as part of a project that otherwise requires a special permit or site plan approval, the parklet may be incorporated into that permit approval process.
- j) When a parklet does not require a special permit or site plan approval from the Planning Board, the parklet requires a blocking permit from the Department of Public Works, which requires approval from the Chief of Police and consultation with the Parking Enforcement Administrator. The standards contained within this section apply at the discretion of the Department of Public Works.

FIGURE 9.4.2 - ILLUSTRATIVE EXAMPLES OF PARKLETS

B. Tactical Urbanism.

1. Tactical Urbanism is the short-term (less than six months) installation of elements within the public realm that are intended to temporarily enliven the public realm, or to pilot test more permanent public realm improvements. Typical examples include temporary parklets, temporary installation of public seating, temporary curb extensions, temporary bicycle lanes, and chalk art.
2. Any allowed Public Realm Component may be tested via Tactical Urbanism with Planning Board approval. The Planning Board may waive any Public Realm Components standards that it deems are inappropriate or unnecessary for a short-term installation. Project proponents are responsible for obtaining any other permits that may apply to their project, for example, permits from the Department of Public Works, the Police Department, the Parking Enforcement Administrator, Board of Selectmen, or other boards as required.



C. Street Banners. Pole mounted street banners and an attractive method of adding color to the public realm and celebrating the districts. Sometimes street banners are coupled with hanging flower baskets. Street banners over the street also add interest for pedestrians and travels. They announce an arrival into the district and provide information about community events.



D. Landmarks and Public Art.

1. Landmarks are designed to commemorate an important event or important person in the history of the Town. Public Art is an artistic expression designed for the enjoyment or education of the general public. Landmarks and Public Art may be freestanding or incorporated as a subordinate feature of any other Public Realm Component or Civic Space. Landmarks and public art installation can take many forms including stone or metal memorials and monuments, sculptures, fountains, plaques, signage, murals, or landscape designs. They should be designed as special features that bring people together and enliven the experience visitors in exploring Winchendon.
2. Standalone Landmarks and Public Art are allowed by-right subject to any other necessary permits.
3. When a long-term Landmark or Public Art installation is included in a project requiring a Special Permit or Site Plan Approval, the Planning Board has jurisdiction over its location, its impacts on other aspects of site design, and its off-site impacts. The Arts Council has jurisdiction over the public art itself.
4. Design standards are as follows:
 - a) The design, size, and placement should be compatible with and integrated with the site or public realm context.
 - b) Landmarks and Public Art must not interfere with the safe movement of pedestrians, bicyclists or motor vehicles
 - c) A three-dimensional Landmark or Public Art installation must be located:
 - 1) At least 7 feet above any area intended for pedestrian movement.
 - 2) 5 feet minimum from fire hydrants;

- 3) 1 foot minimum from any other amenity, utility, or fixture;
 - 4) 2 foot from any Pedestrian Throughway if people are expected to stop and look at the Landmark or Public Art.
 - 5) Where the back of the installation abuts a building, wall, or other obstruction, a 1foot minimum clear width should be provided for maintenance and trash removal.
- d) Landmarks and Public Art must be permanent fixtures and made of materials that will withstand all weather conditions and the test of time.
- e) Installations must be properly maintained.



- E. Art Murals.** A sign that is directly painted on to the exterior wall of a building or screen printed, sewn, or adhered onto a canvas-like material that is mounted flush with the facade of a building that identifies a commercial establishment. Wall murals are intended to be viewed by pedestrians and motor vehicles from a distance. Art murals should be no larger than 1,000 square feet with a maximum width of 75 feet and maximum height of 50 feet.

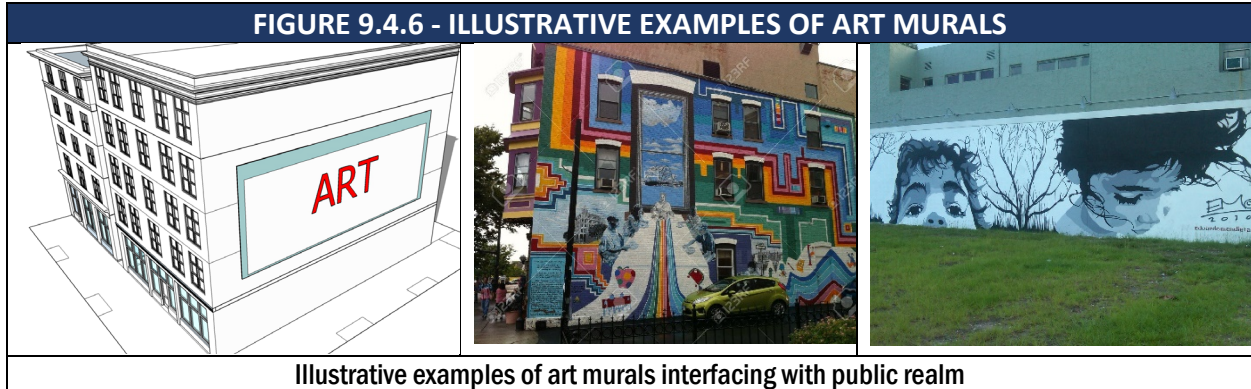

9.5. BUILDING FRONTAGE ZONE

A. Description. The Building Frontage Zone includes the front portion of a lot that abuts a public right-of-way. Though often private property, the Building Frontage Zone is a crucial part of the public realm. This area shapes the public realm (both horizontally and vertically), helps to define its character, and impacts how the public realm is perceived by people. Functionally, the Building Frontage area provides a transition between the public realm and the private realm. It accommodates semi-public or private outdoor spaces like plazas, seating terraces, and gardens or yards. It also accommodates transitional spaces between indoors and outdoors. The figure below illustrates two uses of the Building Frontage Zone. The top diagram shows a building built to the front lot line. The building occupies the Building Frontage Zone. The bottom diagram shows a building set back from the street line. An outdoor seating area and garden occupies the Building Frontage Zone which abuts the Pedestrian Thoroughway without an intervening Public Frontage Zone.

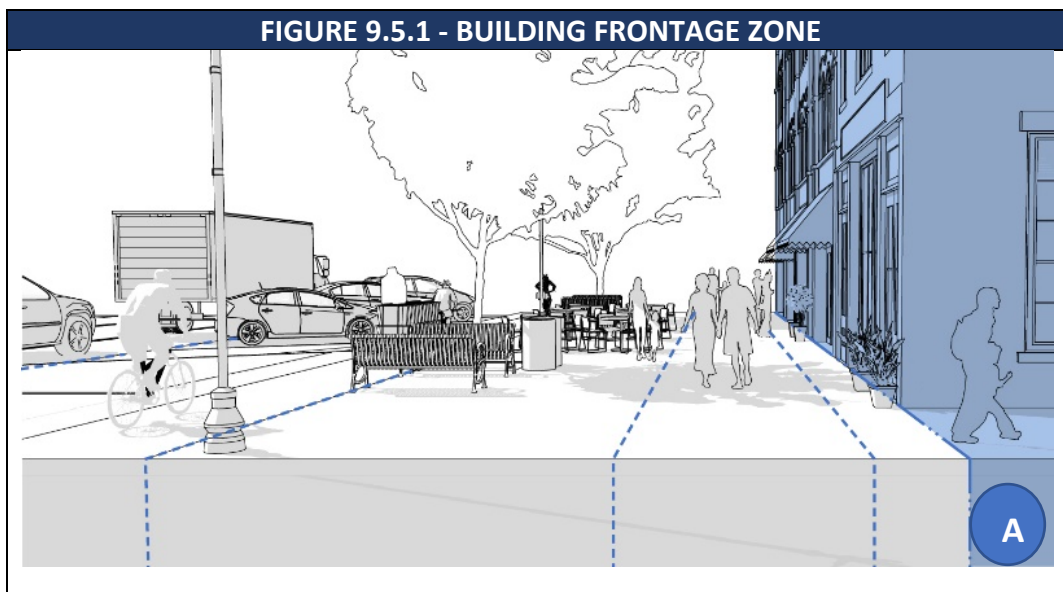

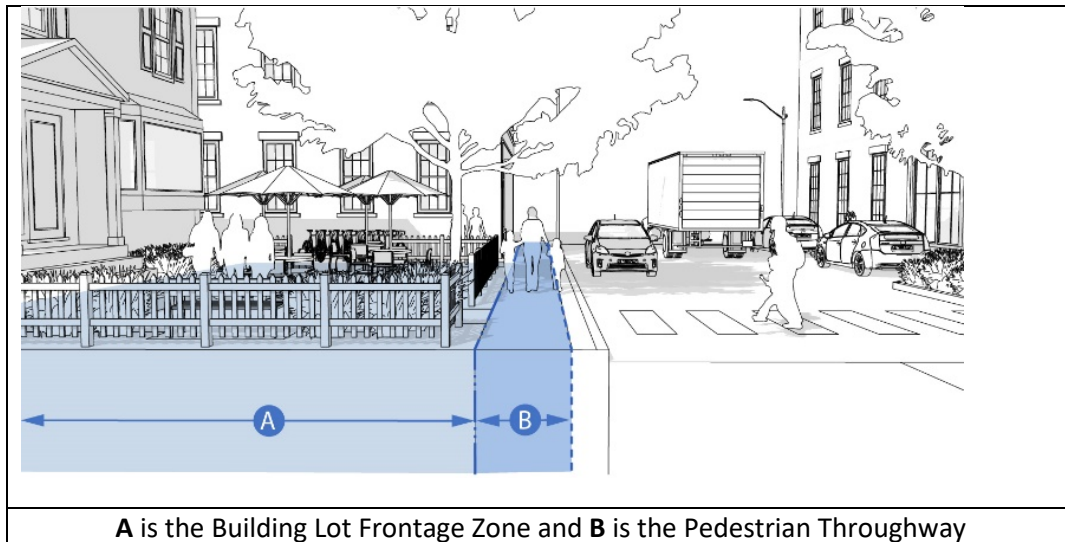

B. Building Frontage Zone Encroachments. Business and property owners are encouraged to collectively create a vibrant and engaging pedestrian environment in the **Planned Development Zoning District** through a series of permanent and temporary activation applications. These activities can take place in the private (building) frontage zone and public frontage zone. The Town may also play an active role in implementing these enhancements in collaboration with businesses and property owners. Frontage encroachments into the public right-of-way is only permitted where there is adequate width for the Pedestrian Throughway and require a permit from the Selectboard.

1. Café Seating/Dining Terrace. See Section 9.3.
2. Merchandise Display. See Section 9.3.
3. Ground Sign. See Section 6.0
4. Sandwich Board Signs. A freestanding portable sign, not secured or attached to the ground or any building or structure, composed of a sign panel and supporting structure or one or more panels which form both the structure and sign face, and which is intended to be placed in a sidewalk or pedestrian way. Sidewalk signs displayed on a public sidewalk should be within 3 feet of the building; are prohibited from interfering with pedestrian travel and must leave clear an accessible walkway area of 5 feet minimum; must be removed when the business is not open; and comply with all applicable town bylaws.

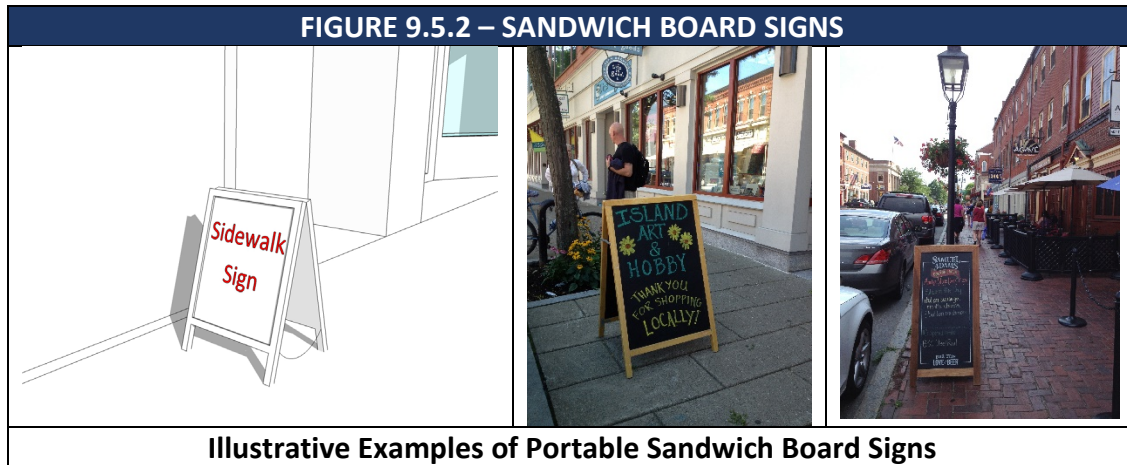

- C. Projecting Banners and Blade Signs.** A building mounted sign attached to, and extending from, a building or support beam in whole or in part which extends beyond said building. Projecting signs may encroach into the public right-of-way but must be located back 5 feet to the closest curb line. Projecting sign should be mounted a minimum of 6 inches away from the building and 8 feet from the bottom of the sign to the sidewalk grade; and comply with all town bylaws.

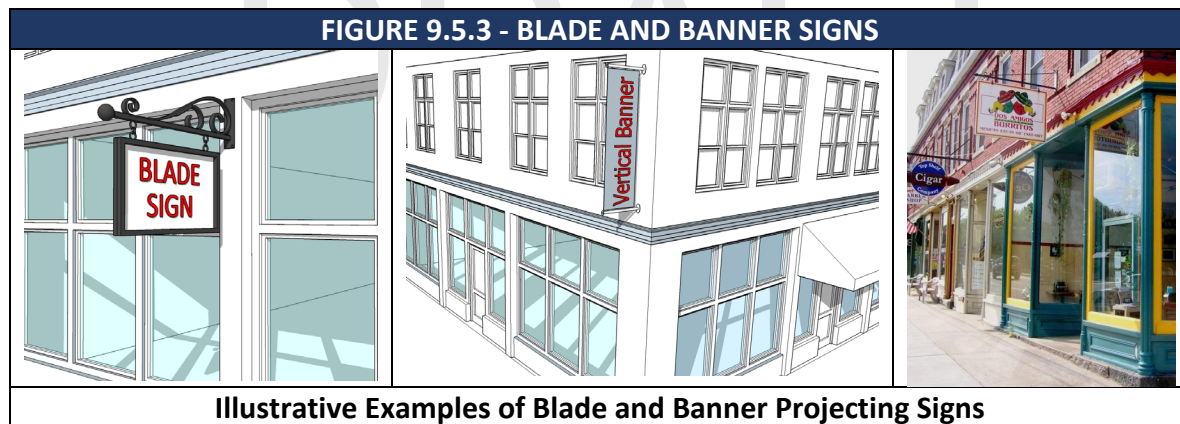

- D. Marquee Signs.** A sign painted on, attached to, or supported by a marquee—a permanent roof-like shelter, either open or covered, extending from part or all of a building face and constructed of some durable material which may or may not project over a public right-of-way. Marquee signs should provide a minimum of 10 feet of clearance above grade and project no more than 10 feet from the building but not closer than 3 feet from the curb line.

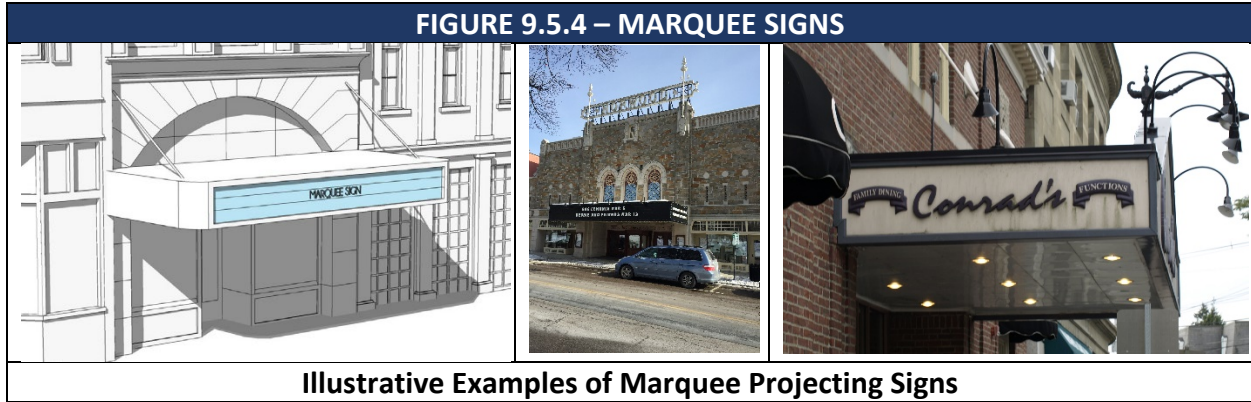

E. Storefront Awning. An awning projecting over a private frontage zone or the sidewalk should have 8 feet of clearance in height, 8 feet in clearance from the curblines, and comply with all applicable town bylaws.



F. Balcony. A balcony projecting over a private frontage zone or public sidewalk should have 12 feet of height clearance, 8 feet in clearance from the curblines, and comply with all applicable town bylaws.

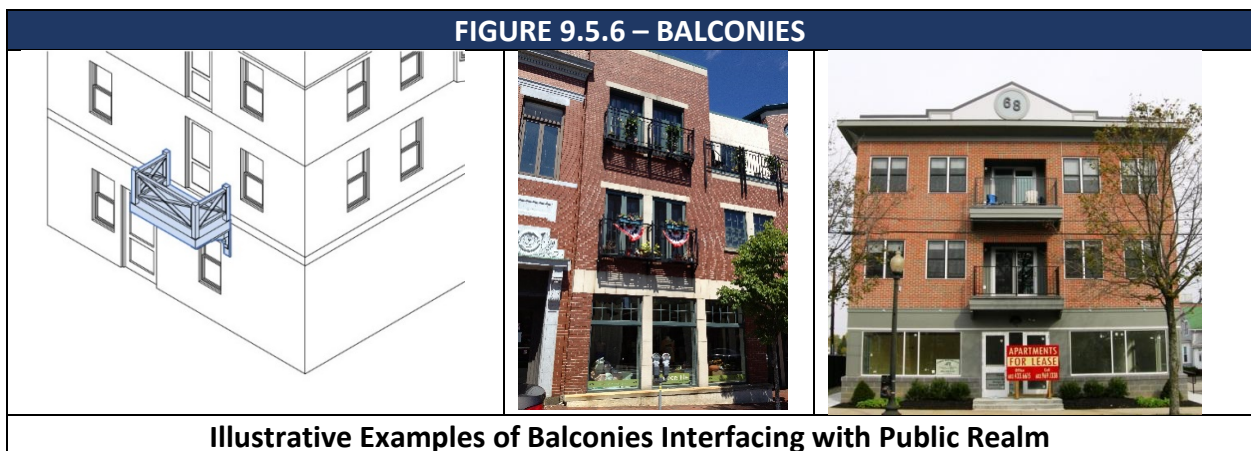

G. Bay Windows. Bay windows projecting over a private frontage zone or public sidewalk should have 12 feet of height clearance, 8 feet in clearance from the curblineline, and comply with all applicable town bylaws.

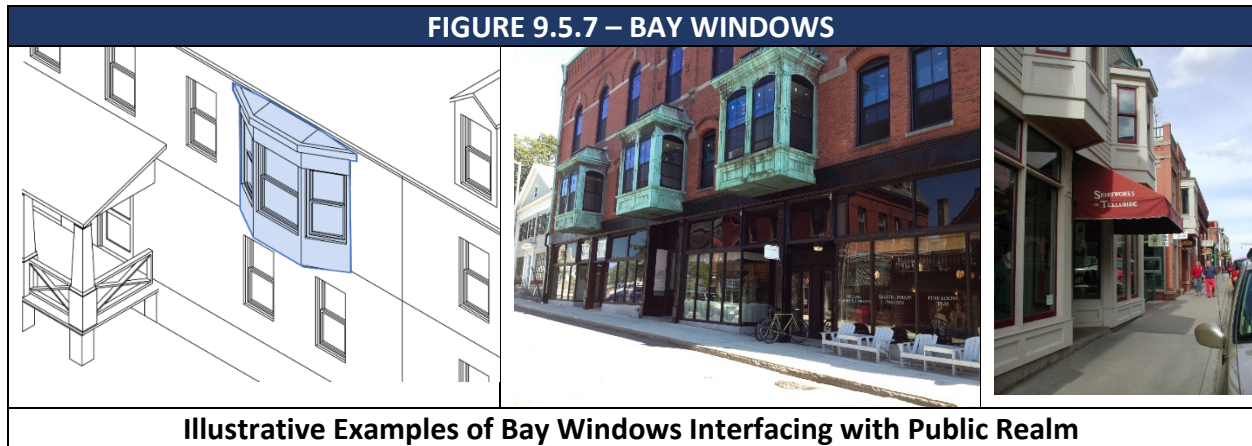

H. Arcade. A building frontage where only the ground floor level of the building facade is set back from the street row line. The building facade for the upper floors is at the street row line and is supported by a colonnade with habitable space above. The arcade is intended for buildings with ground floor commercial, hospitality or retail uses. See arcade design standards in Section **XX**.

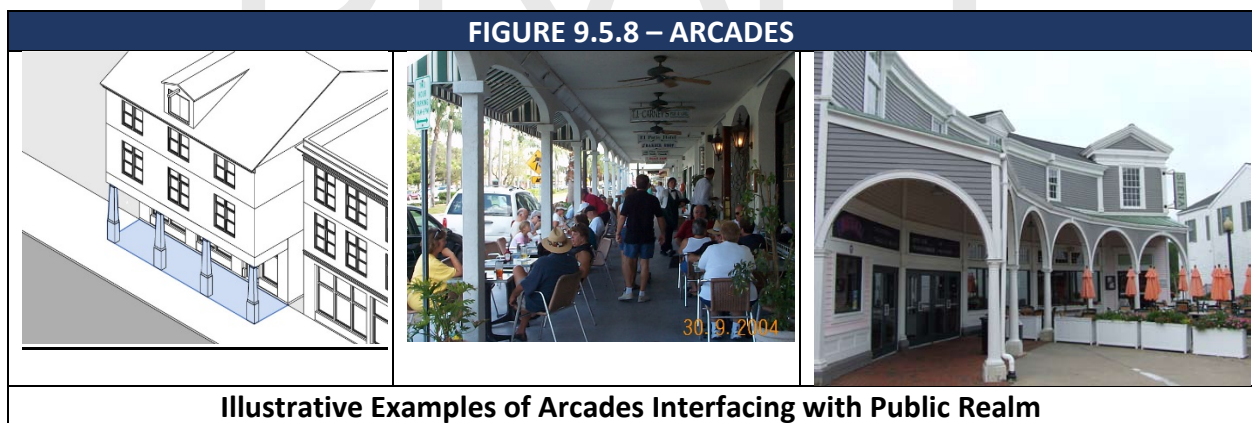

I. Gallery. A building frontage where the facade is set back from the street row line with an attached one or two story cantilevered balcony or colonnade that is built to the street row line. A gallery is intended for buildings with ground floor commercial, hospitality or retail uses. A gallery may project over a public sidewalk with Town approval. See design standards for a gallery in Section **XX**.

FIGURE 9.5.9 – GALLERIES



Illustrative Examples of Galleries Interfacing with Public Realm

DRAFT

10.0 GLOSSARY OF TERMS

This Glossary has been prepared to explain terms used in the *Sustainable Development Standards* that may be technical in nature or specific to Winchendon. Other terms and definitions are part of the *Zoning Bylaw*.

Applicant – The person or entity having the legal authority and who is seeking a permit or approval from the Town of Winchendon to construct or use property subject to the provisions of this *Zoning Bylaw*, or the authorized agent of any such person or entity.

Awning – A sheltering or covered frame, often of fabric, either stationary or on a retractable system attached to a structure. The awning does not receive stanchion support as in a canopy.

Awning or Canopy Sign – A sign painted, stamped, perforated, stitched, or otherwise applied on an awning, canopy or marquee, including backlit signs.

Buffer – Landscape or fencing that is used to screen and/or mitigate the impacts of utilitarian elements of a building or site, such as dumpsters, loading areas, or mechanical equipment.

Buffer Zone – Land which is maintained in either a natural or landscaped state, and is used to screen and/or mitigate the impacts of development on surrounding areas, properties or rights-of-way.

Building – An independent structure having a roof supported by columns or walls resting on its own foundations and designed for the shelter, housing, or enclosure of persons, animals, chattels, or property of any kind.

Building Height – The vertical distance from grade to the top of the highest point of the roof or structure.

Business – Any lawful commercial endeavor to engage in the purchase, sale, lease, exchange or provision of goods and for the provision of services or instruction.

Canopy – A sheltering or covered frame, often of fabric, which is attached to a structure at the inner end and receiving stanchion support at the outer end.

Common Driveway – A privately owned driveway, paved or not, providing vehicular access between two or more buildings and a street. A common driveway does not serve as legal frontage for a lot.

Compatible – A visual and aesthetic consideration that allows two parts to exist or occur together without conflict or diminishment of the other part.

Dark-Sky – An international initiative, embraced by the Winchendon Zoning Bylaw, to reduce light pollution intending to increase the number of stars visible at night, reduce the effects of

unnatural lighting on the environment and cut down on energy usage. The dark-sky movement encourages the use of full-cutoff light fixtures that cast little or no light upward in public areas.

Development Review Committee (DRC) – A committee representing staff from the Building Department, Conservation, Economic Development, Engineering, Environmental Fire Department, Services, Land Use, Health, and Development, Planning, Police, Department of Public Works, Town Manager, and Zoning to assist and advise the Planning Board and its applicants with regard to the site plan review and sustainable development.

Dormer – A roof-covered projection from a sloped roof. A window set in a small gable projecting from a roof.

Eave – The projecting lower edges of a roof overhanging the walls of a building.

Entablature - The upper panel of moldings and bands which lie horizontally above columns. Entablatures are important elements of classical architecture. They are a common area to provide the most prominent signage for a building.

Establishment – A separate and distinct use, business, enterprise, institution, or organization occupying space within a building.

Façade – The substantially vertical exterior surface of a building or structure exposed to public view.

Fence – Any artificially constructed barrier of any material or combination of materials used as a boundary, or erected to prevent intrusion, or to enclose, buffer or screen areas of land.

Frontage – That portion of a lot which fronts on a street or streets from which physical access to the principal building on the lot can be provided. Frontage is measured as the distance between the points of intersection of the side lot lines with the front lot line. In the case of a corner lot bounding more than one street, the measurement on both streets may be used to determine if the lot meets the minimum frontage requirements of the particular zoning district. With a corner lot, the frontage is measured from the side lot line to the midpoint of the arc that constitutes the corner rounding at the intersection of the two streets.

Full-Cutoff Light Fixture – A light fixture that casts little or no light upward.

Gable – The vertical surface that connects two or more sloped roofs. The triangular shaped wall section formed by the two slopes of a roof.

Ground Floor - That building floor which is substantially level with the exterior grade of the lot at the main entrance to a structure.

Human-scaled – The proportional relationship of a particular building, structure or streetscape element to the human form and function.

Impervious Surface – Material or structure on, above, or below the ground that does not allow precipitation or surface water to penetrate directly into the soil.

Landscaped Area – The part or parts of a lot developed and permanently maintained in grass and other plant materials, in which the space is open to the sky and is free of all vehicular traffic, parking, loading and outdoor storage.

Landscape Maintenance Plan – A document that describes the intentions and specifications for maintaining landscape to be installed as part of a development including pest management, irrigation, fertilization, mulching, pruning, staking and seeding requirements to establish and enhance the health of installed landscape.

Lot – A single area of land in one ownership defined by bounds or boundary lines in a recorded deed or shown on a recorded plan.

Lot Frontage – The length of a lot line(s) measured at the street right-of-way line.

Lot Line – A line of record bounding a lot that divides one lot from another lot or from a way or any public space.

Lot Line, Front – A lot line separating a lot from a street right-of-way.

Lot Line, Rear – A line separating a lot from other lots or from land in a different ownership, being the boundary of a lot which is opposite or approximately opposite the front lot line.

Lot Line, Side – Any lot line other than a front or rear lot line.

Low Impact Development (LID) – A term used to describe land planning and engineering design approaches that manage stormwater runoff with an emphasis on conservation, use of on-site natural features, and the protection of water quality.

Massing – The overall form of a building, its physical bulk and volume as it relates to the site.

Monument Sign – A sign, other than a pole sign, with a lower overall height in which the entire bottom is in contact with or close to the ground, independent of any other structure.

Multi-Tenant Development – A group of two or more establishments located in one or more buildings on one or more lots of land under single or multiple ownership, that is designed, planned, constructed or managed as a single entity, with customer and employee parking provided on-site. This includes but is not limited to what is commonly understood and recognized to be a shopping center, office park, or industrial park.

Neck-Down – Also, referred to as a curb extension. A traffic calming measure that extends the curb into the street at an intersection to reduce the pedestrian crossing distance.

Parapet – A low wall or railing that extends above the roof of a building.

Pedestrian-oriented – Describes an approach to circulation or accommodation in which the pedestrian is the primary consideration.

Pedestrian-scale – The relationship between an individual and his or her environment whether natural or built which contributes to an individual’s comfort and sense of accessibility.

Pier - An upright support for a superstructure, such as an arch or bridge. Specific to facades, it often refers to a raised column-like element used to frame windows or bays.

Planning Board (PB) – The Planning Board is the approving authority that that reviews subdivision plans, applications for certain special permits and other site plans for future development for consistency with the *2020 Winchendon Comprehensive Master Plan and Site Plan Rules and Regulations*.

Projecting Sign – A sign, other than a wall sign, affixed to a building or wall in such a manner that its leading edge extends more than eight inches beyond the surface of such building or wall. Projecting signs include but are not limited to awning/canopy sign, banner, marquee sign and suspended sign. Projecting signs are also referred to as blade signs.

Roof – The primary outside protective covering of the top of a building. This includes but is not limited to hip, gable, flat, gambrel, mansard, and shed roof types. Roof shall also mean the exterior protective covering affixed to the top of all other elements projecting from a building façade or its roof including but not limited to porches, dormers, or other similar appurtenances.

Setback – The distance between a structure and any lot line.

Sign or Signage – Any object, design, device, display or structure intended for public view from outside a building, used by a private or public entity to identify, announce, advertise or direct attention to any place or location, object, business, institution, organization, profession, merchandise, product, activity, service, event, person, idea or statement, or to communicate information of any kind to the public by any means including words, letters, figures, designs, pictures, symbols, fixtures, colors, and illumination. Sign shall mean and include any permanent or temporary structure, models, objects, banners, pennants, insignias, trade flags, or other representations that are on a public way or on private property within public view from a public or private street, way or parking area. Any exterior structural surface that is internally or indirectly illuminated or decorated with gaseous tubes or other lights shall be considered a sign.

Site Plan – A scaled illustration depicting the planned layout of buildings, parking, driveways, sidewalks, landscape, stormwater facilities and other features of the lot. The site plan is one element of the required information of a site plan submittal or application.

Street – See definitions below:

- A public way or way which the Town Clerk certifies is maintained and used as a public way.

- A way shown on a definitive subdivision plan approved and endorsed under the Subdivision Control Law and recorded with the Norfolk County Registry of Deeds that is constructed or secured through a covenant or suitable performance guarantee.
- A way already physically in existence on the ground when the Subdivision Control Law become effective in Winchendon and having, in the opinion of the Planning and Economic Development Board, adequate width, construction, and grades for the needs of vehicular traffic for the existing and future buildings and uses abutting thereon or to be served thereby.

Street ROW Line – A lot line separating a lot from a street right-of-way.

Streetscape – The collection of elements that constitute the physical makeup of a street and that, as a group, define its character including building frontage, street paving, street furniture, landscaping, open space areas and lighting.

Structure – Anything constructed or erected at a fixed location on the ground to give support or to provide shelter.

Vista – A unique view to or from a particular point through a passage or opening in a feature of a building or site.

Wall Sign – A sign which is permanently affixed to the façade of a building or structure, or to its porch, canopy, awning, such that its exposed face and all sign surface areas are parallel or approximately parallel to the plane of the building or wall to which it is attached or mounted.

Wayfinding – Wayfinding signage refers to a family of signage products created for the purpose of directing people to & from a defined area, all while guiding them through paths, marking destinations reached, and providing both essential and commercial instructions and data along the way.

Yard – Any open space on the same lot with a principal building, unoccupied, and unobstructed from the ground to the sky, except for accessory buildings or structures, or such projections as are expressly permitted in zoning regulations. A yard lies between the principal building and the lot lines.

Zoning District – The basic unit in zoning. A portion of land in a community to which a uniform set of regulations applies, or a uniform set of regulations for a specific use.

SUSTAINABLE DEVELOPMENT STANDARDS

TABLE OF CONTENTS

1.0 PURPOSE AND APPLICABILITY

- 1.1. Purpose and Intent
- 1.2. Summary of Sustainable Development Elements
- 1.3. Administration
 - A. Pre-Application Review
 - B. Application for Development
- 1.4. Compliance Alternatives

2.0 GUIDING PRINCIPLES

3.0 SUSTAINABLE SITE DEVELOPMENT

- 3.1. Purpose and Intent
- 3.2. Efficient Buildings
 - A. Latent Energy Utilization
 - B. Windows
 - C. Natural Light
 - D. Roof Albedo
 - E. Materials
 - F. Other Sustainable Building Applications
- 3.3. Stormwater Management
 - A. Intent
 - B. Applicability
 - C. Stormwater Best Practices
- 3.4. Natural Landscaping
 - A. Intent
 - B. General Requirements
 - C. Natural Landscaping
 - D. Canopy and Shade Trees
 - E. Treatments
 - F. Infiltration on Recreation Spaces
 - G. Tree Preservation
 - H. Local Food Production
 - I. Installation of Landscape Materials

- 3.5. Efficient Parking and Access
 - A. Intent
 - B. Off-Street Parking Requirements
 - C. Parking Reduction Methods
 - D. Special Parking Types and Standards
 - E. Surface Parking Design Standards
 - F. Structured Parking Standards
 - G. Access
 - H. Parking Waiver Criteria

4.0 RESIDENTIAL DEVELOPMENT FORMS AND BUILDING TYPES

- 4.1. Applicability
- 4.2. Principles in Practice
- 4.3. General Site Improvement Standards
 - A. Site Composition
 - B. Building Orientation
 - C. Site Access
 - D. Internal Site Circulation
 - E. Parking
 - F. Open Space
 - G. Site Furnishings
 - H. Landscape and Streetscape
 - I. Transitional Buffers
 - J. Site Lighting
- 4.4. Residential Development Forms and Patterns
 - A. Purpose and Intent
 - B. Conventional Residential Development (CRD)
 - C. Diversified Residential Development (DRD)
 - 1. Open Space Residential Development (OSRD)
 - 2. Compact Neighborhood Development (CND)
 - 3. Workforce House Infill Lot (WFH)
 - 4. Residential Compound Development (RCD)
 - 5. Residential Frontage Development (RFD)
 - 6. Adaptive Reuse Residential Development (ARRD)
- 4.5. Architectural Guidelines
 - A. Building Massing
 - B. Façade Composition and Components
 - C. Historic Structures
 - D. Building Roof Forms
 - E. Building Light
- 4.6. Residential and Mixed Use Building Types

- A. Standard Single Family House
 - B. Cottage Court and Workforce Cottage
 - C. Duplex
 - D. Triplex
 - E. Multiplex (Multi-Family)
 - F. Townhouse/Rowhouse
 - G. Mixed Use Building
- 4.7. Accessory Residential Buildings
- A. Accessory Dwelling Units
 - 1. Backyard Cottage
 - 2. Carriage House Unit
 - 3. Integrated Unit
 - 4. Penthouse
 - B. Residential Development Community Buildings
 - C. Home Based Accessory Business Units
- 4.8. Signage Standards
- A. General Guidelines
 - B. Sign Harmony
 - C. Site Signage
 - D. Sign Illumination
 - E. Building Massing

IN DEVELOPMENT

5.0 COMMERCIAL/INDUSTRIAL DEVELOPMENT FORMS AND BUILDING TYPES

- 5.1. Purpose and Intent
- 5.2. Principles in Practice
- 5.3. General Site Improvement Standards
- 5.4. Industrial Development and Building Types
- 5.5. Commercial Development and Building Types

6.0 SIGNS

- 6.1. General Standards

7.0 OUTDOOR AMENITY SPACE

- 7.1. General Standards
 - A. Outdoor Amenity Space Types
 - 1. Civic Space (CS)
 - 2. Publicly Oriented Private Spaces (POPS)
 - 3. Private Open Space (PS)

7.2. Outdoor Amenity Space Design Standards

- A. Private Yard and Garden
- B. Dooryard
- C. Forecourt
- D. Community Garden
- E. Courtyard
- F. Common or Green
- G. Plaza or Square
- H. Pocket Park or Playground
- I. Athletic Field or Ball Court
- J. Neighborhood Park
- K. Streetside Terrace
- L. Rooftop Terrace
- M. Pedestrian Passage
- N. Pathway
- O. Other OAS Types

8.0 COMPLETE STREETS

- 8.1. Purpose and Intent
- 8.2. Application
 - A. Public Infrastructure Projects
 - B. Private Participation
- 8.3. Standards for All Thoroughfares
 - A. Complete Street Zones and Components
 - B. Complete Street Design and Construction Standards
- 8.4. Street Types and Design Alternatives
 - A. Applicability
 - B. Waiver
- 8.5. Vehicle Throughway Zone
 - A. Design and Construction
 - B. Travel Lanes
 - C. Bicycle Travel Facilities
 - D. Crosswalks
- 8.6. Street Enhancement Zone
 - A. Overview
 - B. On-Street Parking Lanes
 - C. Curb Extensions
 - D. Bus Facilities
 - E. Utilities

- F. Green Infrastructure
- 8.7. Furnishing & Utility Zone
 - A. Overview
 - B. Width
 - C. Surfacing
 - D. Street Trees and Tree Pits
 - E. Public Seating
 - F. Bicycle Parking
 - G. Driveway and Alley Crossings
- 8.8. Pedestrian Throughway Zone
 - A. Description
 - B. Width
 - C. Accessibility
 - D. Construction
 - E. Pavement

9.0 PUBLIC REALM ACTIVATION

- 9.1. Purpose and Intent
- 9.2. Application
 - A. Public Realm Activation Components
 - B. Activation Permits
- 9.3. Public Frontage Zones
 - A. Description
 - B. General Standards
 - C. Outdoor Café Seating
 - D. Outdoor Retail Displays
 - E. Storefront Window Displays and Signage
- 9.4. Street Enhancement Zone
 - A. Parklets
 - B. Street Banners
 - C. Tactical Urbanism
 - D. Landmarks and Public Art
 - E. Art Murals
- 9.5. Building Frontage Zone
 - A. Frontage Zone Building Placement and Orientation
 - B. Building Frontage Types and Design Standards
 - C. Ground Floor Facade Types and Design Standards
- 9.6. Frontage Encroachments

- A. Ground Signs
- B. Sandwich Board Signs
- C. Projecting Banners and Blade Signs
- D. Marquee Signs
- E. Storefront Awning
- F. Balcony
- G. Bay Windows
- H. Arcade
- I. Gallery

10.0 GLOSSARY OF TERMS

DRAFT

FIGURES

FIGURE 1.1 - CONTEXT-BASED DESIGN AND DEVELOPMENT

FIGURE 1.2 – DEVELOPMENT REVIEW PROCESS

FIGURE 3.3.1 – BIORETENTION

FIGURE 3.3.2 – BIOSWALE

FIGURE 3.3.3 - PERVIOUS PAVEMENT

FIGURE 3.3.4 - GREEN STREET DESIGN AND STORMWATER PLANTERS

FIGURE 3.3.5 - GREEN ROOFS AND WALLS

FIGURE 3.4.1 - INFILTRATION PARKS AND PLAZAS

FIGURE 3.5.1 - TANDEM AND STACKED PARKING

FIGURE 3.5.2 - STREET SIDE PARKING (ON FRONT PROPERTY LINE)

FIGURE 3.5.3 - EXAMPLES OF WELL LANDSCAPES PARKING LOTS AND SHADE TREES

FIGURE 3.5.4 - EXAMPLES OF STRUCTURED PARKING AND FRONTAGE UTILIZATION

FIGURE 4.3.1 – ILLUSTRATIVE EXAMPLES OF SITE COMPOSITION

FIGURE 4.3.2 – ILLUSTRATIVE EXAMPLES OF BUILDING ORIENTATION

FIGURE 4.3.3 – ILLUSTRATIVE EXAMPLES OF SITE CIRCULATION

FIGURE 4.3.4 – ILLUSTRATIVE EXAMPLES OF PARKING PLACEMENT AND DESIGN

FIGURE 4.3.5 – ILLUSTRATIVE EXAMPLES OF LANDSCAPE AND STREETScape DESIGN

FIGURE 4.3.6 – TRANSITIONAL LANDSCAPE AND BUILDING BUFFER

FIGURE 4.4.1 - EXAMPLE OF CONVENTIONAL AND DIVERSIFIED RESIDENTIAL DEVELOPMENT

FIGURE 4.4.2 – EXAMPLE OF OPEN SPACE RESIDENTIAL DEVELOPMENT (OSRD)

FIGURE 4.4.3 – ILLUSTRATIVE EXAMPLE OF COTTAGE COURTS (CND-CC)

FIGURE 4.4.4 – EXAMPLE OF TRADITIONAL NEIGHBORHOOD DEVELOPMENT (CND-TND)

FIGURE 4.4.5 – EXAMPLE OF COHOUSING DEVELOPMENT (CND-CD)

FIGURE 4.4.6 – ILLUSTRATIVE EXAMPLE OF A RESIDENTIAL COMPOUND (RCD)

FIGURE 4.4.7 – ILLUSTRATIVE EXAMPLE OF A RESIDENTIAL FRONTAGE DEVELOPMENT (RFD)

FIGURE 4.4.8 – EXAMPLE OF A RESIDENTIAL ADAPTIVE REUSE DEVELOPMENT (AARD)

FIGURE 4.4.9 - OPEN SPACE RES. DEVELOPMENT & COMPACT NEIGHBORHOOD DEVELOPMENT STANDARDS

FIGURE 4.4.10 - ALLOWED BUILDING TYPES IN DIVERSIFIED RESIDENTIAL DEVELOPMENTS

FIGURE 4.5.1 – ILLUSTRATIVE EXAMPLES OF ARCHITECTURAL APPLICATION

FIGURE 4.6.1 - STANDARD SINGLE FAMILY HOUSE DESIGN GUIDELINES

FIGURE 4.6.2 - COTTAGE COURT AND WORKFORCE COTTAGE DESIGN GUIDELINES

FIGURE 4.6.3 - DUPLEX DESIGN GUIDELINES

FIGURE 4.6.4 - TRIPLEX BUILDING DESIGN GUIDELINES

FIGURE 4.6.5 - MULTIPLEX BUILDING DESIGN GUIDELINES

FIGURE 4.6.6 – TOWNHOUSE/ROWHOUSE DESIGN GUIDELINES

FIGURE 4.6.7 - MIXED USE BUILDING DESIGN GUIDELINES

FIGURE 4.7.1 - DESIGN GUIDELINES FOR ACCESSORY DWELLING UNITS

FIGURE 4.7.2 - DESIGN GUIDELINES FOR COMMUNITY BUILDINGS IN RESIDENTIAL DEVELOPMENTS AND HOME BASED BUSINESSES

TABLE 4.8.1 – ILLUSTRATIVE EXAMPLES OF SIGN DESIGN

SIGNS

TABLE 4.1 - OUTDOOR AMENITY SPACE TYPES AND DESIGN STANDARDS

FIGURE 5.1 - COMPLETE STREET ZONES AND COMPONENTS

FIGURE 5.2 - COMPLETE STREET TYPES AND DESIGN OPTIONS

FIGURE 5.3 - PEDESTRIAN CROSSWALK DESIGN STANDARDS

FIGURE 5.4 - STREET ENHANCEMENT ZONE

FIGURE 5.5 - CURB EXTENSION DESIGN STANDARDS

FIGURE 5.6 - FURNISHING & UTILITY ZONE

FIGURE 5.7 - STREET TREE PLANTER DESIGN STANDARDS

FIGURE 5.8 - RECOMMENDED ELEMENTS OF A MODULAR SUSPENDED PAVEMENT SYSTEM

FIGURE 5.9 - ILLUSTRATIVE EXAMPLES OF PUBLIC SEATING

FIGURE 5.10 - PUBLIC SEATING ORIENTATION

FIGURE 5.11 - BICYCLE PARKING DESIGN STANDARDS

FIGURE 5.12 - DRIVEWAY AND ALLEY CROSSING DESIGN STANDARDS

FIGURE 5.13 - PEDESTRIAN THROUGHWAY ZONE

FIGURE 5.14 - PEDESTRIAN THROUGHWAY DESIGN STANDARDS

FIGURE 6.1 – ACTIVATION OF THE OUTDOOR ROOM

TABLE 4 - PUBLIC REALM ACTIVATION COMPONENTS

FIGURE 24 - PUBLIC FRONTAGE ZONE

FIGURE 25 - OUTDOOR SEATING CAFÉ DESIGN STANDARDS

FIGURE 26 - ILLUSTRATIVE EXAMPLES OF CAFÉ SEATING

FIGURE 27 – OUTDOOR RETAIL DISPLAYS

FIGURE 28 - PARKLET DIAGRAM

FIGURE 29 - ILLUSTRATIVE EXAMPLES OF PARKLETS

FIGURE 30 - ILLUSTRATIVE EXAMPLES OF TACTICAL URBANISM

FIGURE 31 - ILLUSTRATIVE DIAGRAM OF PUBLIC ART INSTALLATION

FIGURE 32 - BUILDING LOT FRONTAGE ZONE

FIGURE 34 – BUILDING FAÇADE ORIENTATION AND CORNER SETBACK

FIGURE 35 - VERTICAL & HORIZONTAL FACADE MODULATION AND ARTICULATION

FIGURE 36 – BUILDING FAÇADE ELEMENTS

FIGURE 37 - GROUND AND UPPER FLOOR TRANSPARENCY

FIGURE 38 - EDGE BUILDING FRONTAGE DESIGN STANDARDS

FIGURE 39 - FORECOURT BUILDING FRONTAGE DESIGN STANDARDS

FIGURE 40 - ARCADE BUILDING FRONTAGE DESIGN STANDARDS

FIGURE 41 - GALLERY BUILDING FRONTAGE DESIGN STANDARDS

FIGURE 42 - FRONT PLAZA AND SEATING TERRACE DESIGN STANDARDS

FIGURE 43 - STOREFRONT FACADE DESIGN STANDARDS

FIGURE 44 - OFFICEFRONT FACADE DESIGN STANDARDS

FIGURE 45 - CIVIC FACADE DESIGN STANDARDS

FIGURE 46 – SANDWICH BOARD SIGNS

FIGURE 47 – BLADE AND BANNER SIGNS

FIGURE 48 – MARQUEE SIGNS

FIGURE 49 – STOREFRONT AWNINGS

FIGURE 50 – BALCONIES

FIGURE 51 – BAY WINDOWS

FIGURE 52 – ARCADES

FIGURE 53 – GALLERIES

DRAFT

1.0 PURPOSE AND APPLICABILITY

1.1 PURPOSE AND INTENT

The Winchendon Planning Board adopted the Winchendon Sustainable Development Standards in (DATE) in accordance with MGL Chapter 40A to supplement the development review process as part of the Planning Board Rules and Regulations. These development and design guidelines are intended to be used by the Planning Board for all eligible development projects under the Winchendon Zoning Bylaw, Article 12 - Site Plan Review.

The purpose of the Sustainable Development Standards is to establish the minimum requirements and expectations for the quality of design for development and investment in the Town of Winchendon. Applicants are encouraged, but not required, to achieve beyond the scope of these standards and guidelines in each sustainability category.

Any development that requires Site Plan or Special Permit approval administered by the Planning Board is required to follow the Sustainable Development Standards. Adherence to the Sustainable Development Standards helps applicants to achieve approval and may accelerate the review process. The standards also establish a framework for site plan review by the Planning Board.

The Planning Board's broad intention in adopting the Sustainable Development Standards is to maintain and/or improve the quality of life of Winchendon residents, the value of property and the viability of commerce districts through the use of context-based design and sustainable development practices. The Sustainable Development Standards and review process encompass a range of topics and aspects of site planning and design. This requires the collaboration of multiple disciplines and perspectives such as architecture, landscape architecture, civil engineering, urban design, and community planning to achieve a meaningful, economically viable, environmentally sustainable, and aesthetically pleasing site plan.

1.2 SUMMARY OF SUSTAINABLE DEVELOPMENT ELEMENTS

The Sustainable Development Standards contains Private Realm and Public Realm components. For example, Private Realm design standards address site access, parking placement, landscaping and screening, stormwater management, building placement, frontages and façade treatments, outdoor amenity spaces, and other site design elements. Public Realm design standards address street design, streetscape treatments, on-street parking, pathways, utilities, and related elements.

In any vibrant neighborhood, village center, or commercial/industrial district, there is a strong, supportive relationship between private development and public spaces such as streets and open spaces. In particular, the transitional areas in pedestrian-oriented districts are critical such as the placement, orientation, and access to buildings in relationship to streets and sidewalks. The Sustainable Development Standards are intended to reinforce the strong relationship between the Private Realm and Public Realm with the understanding that there’s an investment to be made and benefit to be realized by the developer as well as the Town.

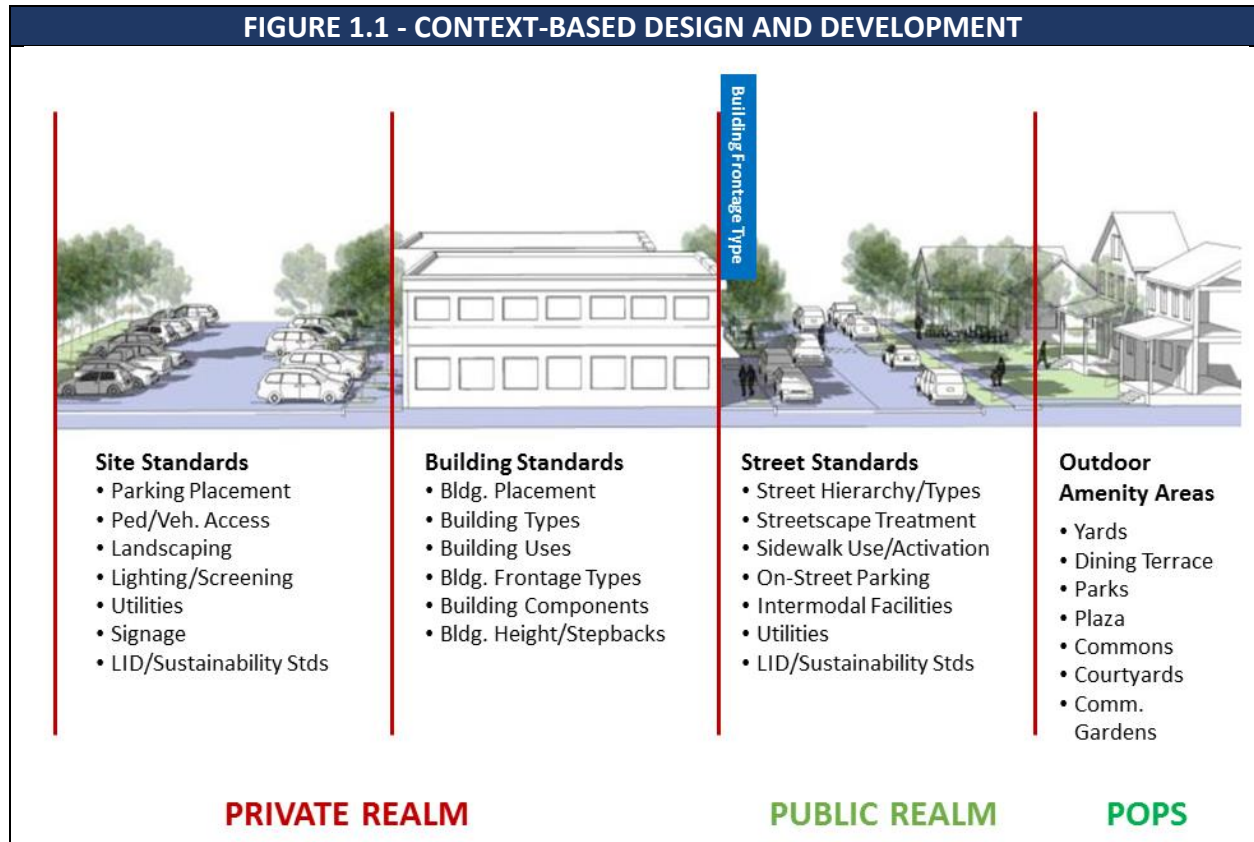

1.3 ADMINISTRATION

Winchendon property owners are strongly encouraged to use the Sustainable Development Standards when planning and designing potential renovations, redevelopment, or new buildings of their properties. Any significant change to an existing building or property will likely require site plan review with the Planning Board. Town staff will review preliminary plans and applications for compliance with the Winchendon Zoning Bylaws and consistency with these Sustainable Development Standards prior to submitting a formal application. Once a formal application is submitted, Town staff will review the plans and prepare a report with recommendations for the Planning Board consideration.

A. Pre-Application Review.

Applicants are encouraged to meet with town staff prior to submitting a formal development application to the Planning Board and its formal review. During the pre-application phase, both site and building designs can be discussed as they relate to the Sustainable Development Standards. The objective is to provide an open discussion and a mutual understanding of both the development opportunities and challenges posed by a particular site and development program. This type of dialogue can enhance the efficiency of the approval process and outline design directions that are mutually beneficial to the Town and applicant. At any point in the process, the Winchendon Planning Development is available for permitting guidance and assistance.

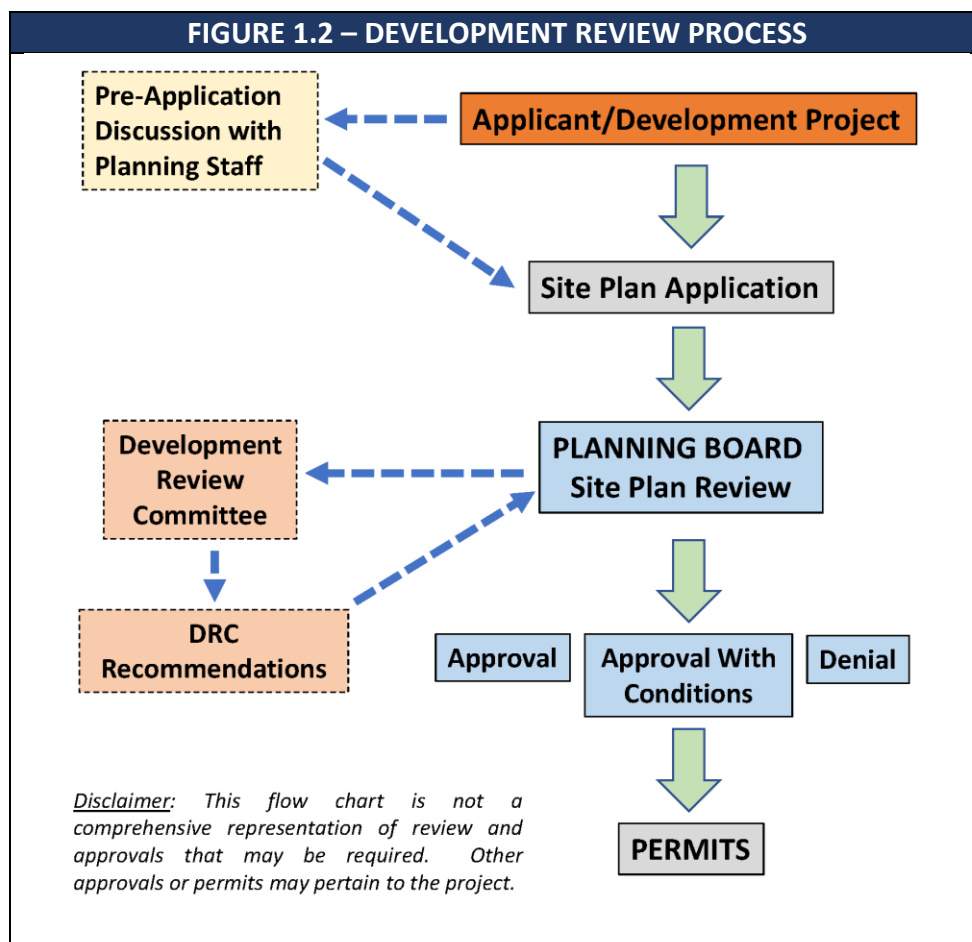

Commentary: Is there/should there be a Development Review Committee (DRC) for the purpose of reviewing conceptual or preliminary site plan applications? Maybe representatives of Planning, ED, DPW, Building, Land Use, and selected committees?

B. Application for Development.

Development review is initiated by the Planning Board upon receipt of a Site Plan or Special Permit Application. The Planning Department will provide an initial review, according to a Sustainable Development Standards Checklist. This review determines the areas of focus for discussion between the applicant and the Planning Board. The Planning Board and applicant then meet to discuss the development and its compliance with the Sustainable Design Standards. The planning staff presents final written recommendations to the Planning Board.

1.4 COMPLIANCE ALTERNATIVES

It can be difficult for Sustainable Development Standards to predict all possible site planning and design scenarios, or anticipate new trends, technologies or best practices. If specific sustainability standards will not be followed by an applicant because they feel a better approach to reinforcing the Town's sustainable community principles exists for their individual development and design circumstances, a compliance alternative may be reached as an agreed upon method to comply with the intention of the Standards. This option provides a process to arrive at innovative design solutions that all parties agree will follow the intent of the Standards. The applicant must specifically identify the areas in which they seek a compliance alternative with a Compliance Alternative Request Form, and the Planning staff provides an opinion and recommendation regarding the alternative approach in writing to the Planning Board. Please contact the Winchendon Planning and Development Department for further information.

2.0 GUIDING PRINCIPLES IN PRACTICE

These guiding principles reflect Winchendon's goals and aspirations for a sustainable community today and for future generations. These sustainability principles are consistent with the 2020 Winchendon Community Master Plan, 2021 Municipal Vulnerability and Hazard Mitigation Plan, 2015 Open Space and Recreation Plan, and [Housing Needs Assessment/Production Plan \(Year\)](#).

SUSTAINABLE GROWTH AND DEVELOPMENT

Development projects should strive to address the highest ecological principles by protecting and enhancing the overall health, natural environment, and quality of life of Winchendon. Air, water, light, and land pollution should be minimized. Both site design and construction of buildings should result in efficient use, reuse, and recycling of resources, including energy, water use, and construction materials. The Planning Board highly favor projects that intend to seek certification under the Leadership in Energy and Environmental Design (LEED) Green Building Rating System and the LEED-Neighborhood Development Rating System™.

Low Impact Development (LID) techniques should be used to reduce the concentration of stormwater runoff and maintain existing stormwater flows. Where feasible, bioswales, rain gardens and other bioretention techniques should be employed. Green roofs and rain storage systems are encouraged in order to reduce and reuse roof drainage. Pervious paving materials should be used where feasible to reduce runoff from hardscaped areas and integrated into the design of the project.

COMPACT DEVELOPMENT AND HUMAN SCALE DESIGN

Encourage compact development in order to promote a more efficient use of land, reduce dependency on personal vehicles for travel, and reduce the costs of providing public infrastructure and services. Development should be designed for the human scale, considering the relationship between the dimensions of the human body and the proportion of traveled ways, public spaces, and buildings. Site design should consider how various site features enhance pedestrian mobility, safety, comfort, enjoyment, and walking distance to other off site amenities. The design of buildings, streetscapes, signs, open spaces, and other features should be determined based on what will create a pleasant environment for the pedestrian.

MIXED USES AND FLEXIBLE BUILDING SPACE

Designated areas of Winchendon should include a mixture of residential, commercial, and civic uses at a scale appropriate for the community. Mixed use development can be an important sustainability tool in certain residential and commercial districts by including a mix of housing types and sizes to accommodate households of a broad range of ages, sizes, incomes and physical

abilities. Mixed use can also reduce personal vehicle use, promote health, and expand economic opportunities. To encourage vibrant commercial districts and dynamic neighborhoods, housing may be appropriate adjacent to or above commercial uses such as shops or offices forming a “Live, Work, Play” district.

ARCHITECTURAL CONTEXT AND ADAPTIVE REUSE OF HISTORIC STRUCTURES

In Winchendon Town Center and older neighborhoods, new buildings should be designed to reflect traditional New England “village” architecture such as Greek Revival, Georgian, Colonial Revival, Shingle, and Stick. Architecture should also be varied but compatible in scale. Existing historic buildings should be renovated and rehabilitated for adaptive reuse as a first resort is structurally and economically viable. Contemporary design in selected non-historic residential, commercial, and industrial districts may be appropriate and encourage to reflect modern technology and innovation as a component of the community.

NEIGHBORHOOD PRESERVATION AND EXPAND HOUSING CHOICES

A broad range of housing choices at moderate density in Winchendon should be provided. Housing may also be appropriate in selected commercial and industrial districts to support local business in terms of customers and employment base. Increased housing choices can be incorporated in a variety of development forms such as cottage courts, open space residential developments, housing cooperatives, townhouses, rowhouses, multi-family buildings, mixed-use development, and accessory dwelling units. These building types and development forms should also provide a positive transitional between commercial districts and surrounding neighborhoods. Convenient pedestrian and vehicular connections should be provided between districts by a network of streets, sidewalks, bikeways, crosswalks, and trails. At the same time residential areas should be protected from unwanted traffic, visual intrusion, and negative impacts to the pace and scale of their environments.

ACTIVE OPEN AND CIVIC SPACE

New development should contribute to the successive increase of private and publicly-oriented open spaces within Winchendon. Active and shared outdoor spaces should be a major element of any development plan, providing a clear purpose of social and community interaction, and fostering participation in civic activities. The type and distribution of Outdoor Amenity Spaces should be coordinated with municipal facilities such as the Winchendon Rail Trail, GAR Park, and other existing and future open and civic spaces across Winchendon.

QUALITY LANDSCAPE AND STREETScape CHARACTER

Landscaping and streetscaping should be arranged in such a way as to act as a unifying element between buildings, sidewalks, streets, pathways and public spaces. Special attention should be given to street trees which in general should be located between curb and sidewalk and should

be continuous along all primary and secondary streets. Landscaping should complement the scale of a development project and its surroundings. In general, larger, well-placed contiguous planting areas are preferred to smaller, disconnected areas. Open spaces should be integrated throughout a development project with an emphasis on functionality – such as providing a comfortable, shaded place to sit – and not simply aesthetic appeal.

MULTI-MOBILITY IN TRANSPORTATION NETWORK

An interconnected network of circulation systems that facilitate walking, bicycling, and driving is a sustainability goal in Winchendon. Streets should be designed to establish a satisfactory level of service for vehicular travel and promote the safe and efficient use of different transportation modes. A connected street pattern should limit the need for dead-end streets in order to create multiple routes for pedestrians, bicyclists, and motorists. Streets should incorporate “traffic calming” techniques, such as differentiated paving, smaller turning radii, and/or street trees, to slow traffic speed and promote pedestrian safety. New development projects should implement traffic mitigation best practices to enhance walking, bicycling, ride-sharing, car sharing and public transit as a viable alternative to personal vehicles.

ECONOMIC OPPORTUNITY

New commercial and industrial development should expand and diversify the Winchendon economy through new business development and job creation. Sustainable economic development requires flexibility in order to fulfill market opportunity and business diversity while requiring high quality design and development.

3.0 SUSTAINABLE SITE DEVELOPMENT

3.1 PURPOSE AND INTENT

- A. To facilitate best practices in site design including sustainable stormwater management techniques, landscaping, and low impact development.
- B. To ensure energy saving building features are properly designed and appropriately installed which encourage the passive cooling of interior spaces and reduce the need for electrical air conditioning; protect circadian rhythms and enhance the happiness and productivity of building occupants by visually connecting them with the outdoors and introducing natural daylight into interior spaces; and minimize heat island impacts on the urban environment.

3.2 EFFICIENT BUILDINGS

All buildings in Winchendon should strive to achieve a zero net energy goal of 100% through best practices in design and construction practices such as governed by the Energy Star Program and the U.S. Green Building Council LEED Rating System.

- A. **Latent Energy Utilization (Solar/Geothermal).** The energy naturally existing within a site is its latent energy. In the northeast, this is most often in the form of solar energy coming from the sun, and geothermal energy in the form the stable temperature of the ground despite seasonal temperature swings. The use of solar thermal and solar photovoltaic techniques is highly encouraged. Massing of buildings should be considerate of solar access to neighboring properties, particularly allowing sun during winter to properties immediately to the north.
 - 1. Whenever possible buildings should be of a size and orientation to minimize the blocking of sunlight on public spaces such as sidewalks.
 - 2. Windows should be oriented to make the best use of passive solar heating.
 - 3. The primary roof plane should face as close to solar south as possible, to allow for installation or retrofit with solar panels.
 - 4. Gable roofs and shorter buildings may be more appropriate on the south sides of a street while gable end roofs and taller buildings may be more suited for the north side.
- B. **Windows.**
 - 1. At least fifty percent (50%) of the windows of each floor of a building and serving each dwelling unit should be operable.

2. Operable windows should be oriented toward prevailing winds to every extent possible and support the creation of cross breezes that can assist in the passive cooling of interior spaces.
3. All south facing windows should be recessed or shaded by deciduous trees, awnings, canopies, or interior or exterior light shelves.
4. If installed, shutters should be functional, sized to provide complete coverage of the window when closed, and include appropriate hardware to keep them secured when open or closed.

C. Natural Light. The following apply to multi-family and commercial buildings:

1. A minimum of fifty percent (50%) of the floor area of all regularly occupied interior spaces should receive sufficient daylight equal to a spatial daylight autonomy of three hundred (300) lux or more for at least fifty percent (50%) of the time.
2. A direct line of sight to the outdoors should be provided for at least seventy-five percent (75%) of the floor area of all regularly occupied interior spaces.

D. Roof Albedo.

1. Flat roofs and roofs pitched at or below nine and one-half degrees (9.5°; 2:12) should have a minimum solar reflectance index rating of seventy-eight (78) for a minimum of seventy-five percent (75%) of the roof surface.
2. Roofs pitched above nine and one-half degrees (9.5°; 2:12) should have a minimum solar reflectance index rating of twenty-nine (29) for a minimum of seventy-five percent (75%) of the roof surface.

E. Materials.

1. High-quality, Locally Sourced Materials. The durability and aesthetic value of a material is intrinsically related to its quality. Choosing high-quality materials ensures that the buildings last. Locally sourced materials offer an additional layer of benefits in the form of stimulating the local economy, reducing the energy involved in transportation, and being a product of the area.
2. Recyclable, Low Embodied Energy Materials. The carbon footprint of a material is a product of the cumulative amount of energy invested in it over its lifespan, including the harvesting of raw materials, refinement, production, transportation, and disposal. Choosing materials that require lower levels of energy at each stage of this process can substantially lessen its environmental impact. If the product is designed to be recycled, this reduces the energy needed to harvest raw materials in its next iteration.

3. Environmentally and Historically Appropriate Materials. Exterior cladding and detailing should be chosen for its ability to work with the local climate and resist degradation. Materials should be honest about the time in which they are employed.
4. Texture, Variation and Tactility. Natural materials such as wood and stone are good materials, as they read as monolithic from a distance but revealing variations in tone and texture as one moves closer towards them. Finding the correct number of materials for the façade of a building is a balancing act: too few and a building can look uninteresting and stark; too many and it can appear overstimulating and busy.

F. Other Sustainable Building Applications. Applicants are encouraged to use other sustainable practices to improve building envelope energy efficiency and to use materials and equipment that reduce energy consumption in Winchendon such as the following:

1. Natural cooling through appropriate glazing, shading of glazed surfaces, and operable windows.
2. Wind and roof-mounted solar energy generation.
3. Ground source heat exchange (closed system geothermal energy).
4. On-site biomass use for energy production.
5. Renewable heat and cooling (i.e. sunlight, rain, wind).
6. Combined heat and power systems.
7. Green walls and green blocks.
8. Increased insulation (i.e. R-26 and triple-glazed windows)
9. Energy Star rated appliances.
10. EcoStar Program (shared recycling streams between park tenants).
11. Dual-flush and waterless toilets.
12. Ultra-efficient heat and hot water systems.
13. Open and simple floor plans (i.e. square and cubes).
14. Improved building air seal (i.e. taped sheathing).
15. Greywater systems.

3.3 STORMWATER MANAGEMENT

A. Intent.

The stormwater management measures proposed for site development shall conform with the **Winchendon General Codes, Section XXX** – Stormwater Management, and to the best management practices described in the Commonwealth of Massachusetts Stormwater Management Handbook, as may be amended from time to time. The intent of this sections is the following:

1. To promote stormwater management practices that maintain pre-development hydrology through site design, site development, building design and landscape design techniques that infiltrate, filter, store, evaporate and detain stormwater close to its source;
2. To protect water resources and other natural aquatic systems on the development site and elsewhere from degradation that could be caused by construction activities and post-construction conditions;
3. To protect other properties from damage that could be caused by stormwater and sediment from improperly managed construction activities and post-construction conditions on the development site;
4. To reduce the impacts on surface waters from impervious surfaces such as streets, parking lots, rooftops and other paved surfaces; and
5. To promote public safety from flooding and streambank erosion, reduce public expenditures in removing sediment from stormwater drainage systems and natural resource areas, and to prevent damage to municipal infrastructure from inadequate stormwater controls.

B. Applicability.

1. Consistent with stormwater management best practices, new development projects should maintain or achieve pre-development hydrology through sustainable site design techniques that infiltrate, filter, store, evaporate and detain storm water close to its source.
2. The post-construction peak runoff rate for the one-year, twenty-four (24) hour rain event shall not exceed the existing peak runoff rate for the same storm event from the site under existing conditions prior to submittal of an application. Low Impact Development (LID) practices as identified below should be incorporated into the design as necessary to achieve the required runoff rate. If constraints prevent the use of these LID practices,

other stormwater treatment best practices detailed in the Commonwealth of Massachusetts Stormwater Management Handbook may be used to achieve the required post construction runoff rate.

C. Stormwater Best Practices

1. Minimization of Impervious Surface: Impervious surface shall be minimized by: providing only as much parking as required by **Article 8** of the Zoning Bylaw; using short and narrow driveways, permeable paving, green rooftop systems, and low impact development techniques as described in references such as the Massachusetts Executive Office of Environmental Affairs LID homepage in current versions wherever possible (<http://www.mass.gov/envir/lid/default.htm>).
2. District Stormwater System: When an entire district or large scale development is planned at once, one storm water management system may be developed to manage the whole development. Increased runoff in one area can be balanced by greater infiltration in another, through incorporation into a collective District Stormwater System which results in the reduction in release rates and runoff volumes.
3. Light Imprint Site Layout: Light imprint applications shall integrate hydrology and storm water management into site design using existing conditions to influence the location and layout of roadways, buildings, and parking areas. Buildings and roadways should be placed in areas less sensitive to disturbance, and the storm water management system design should create a symbiotic relationship between the development and natural hydrology. The attention to natural hydrology and nonstructural storm water management creates a more attractive, multifunctional landscape.
4. Filter Strips and Bioretention: Filter strips are bands of densely vegetated slopes, designed to reduce water runoff volume and improve water quality prior to entering storm water drainage basins. Filter strips are typically designed to break up impervious surfaces (such as parking lots) and provide initial storm water treatment by filtration. They also provide infiltration of water, reducing the overall amount of runoff. Filter strips shall be incorporated into roadway and parking lot designs.

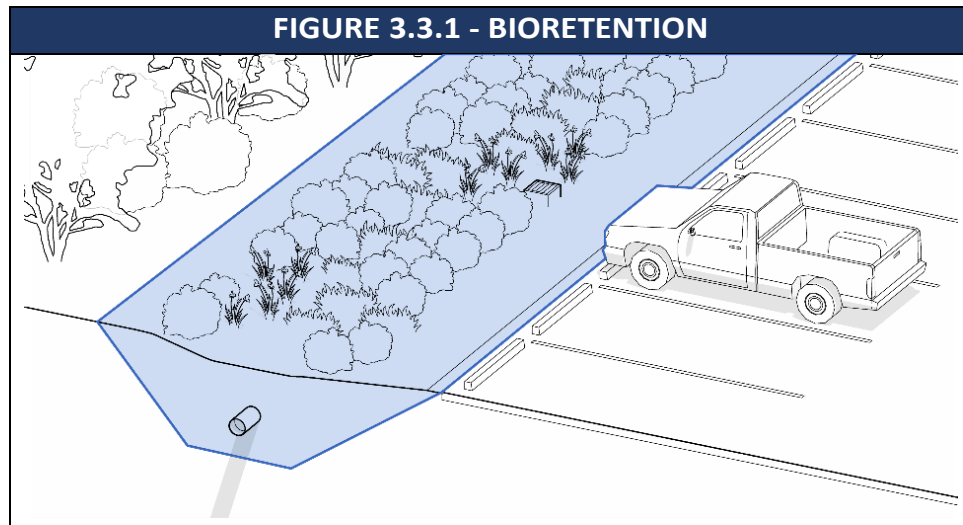

5. **Vegetated Swales (Bioswales)**. Vegetated swales are broad, shallow channels designed to convey and infiltrate storm water runoff. Swales are to be used as a preferred alternative to closed, non-infiltrating drainage systems. The design of swales should seek to reduce storm water volume through infiltration, improve water quality through infiltration and vegetative filtering, and reduce runoff velocity by increasing flow path lengths and channel roughness.

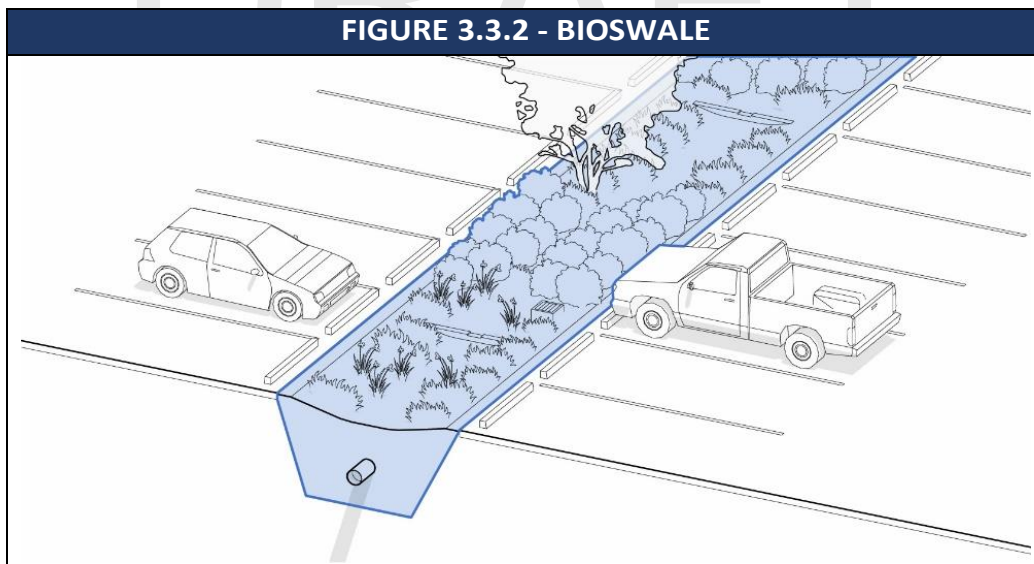

6. **Bioretention Cells (Rain Gardens)**. Rain gardens (also known as bioretention cells) are vegetated depressions that store and infiltrate runoff. Rain gardens are designed to encourage vegetative uptake of storm water to reduce runoff volume and pollutant concentrations. A well designed rain garden has an engineered soil, which maximizes

infiltration and pollutant removal while avoiding storm water ponding for longer than 24 hours. Combined with filter strips, bioretention cells are important components of the LID treatment process and are incorporated into roadway and parking lot designs.

7. Pervious Pavement. Permeable paving reduces stormwater runoff volume, velocity and pollutants by allowing water to infiltrate into the sub-surfaces below parking areas. They are generally appropriate for low-traffic parking lots. They can be incorporated as a hybrid parking lot, which uses conventional paving for driveways and aisles, and permeable paving for parking stalls. Permeable paving may also be appropriate for overflow parking areas, which are generally used only a few weeks out of the year. Maintenance of pervious pavements is critical to maintain the permeability.

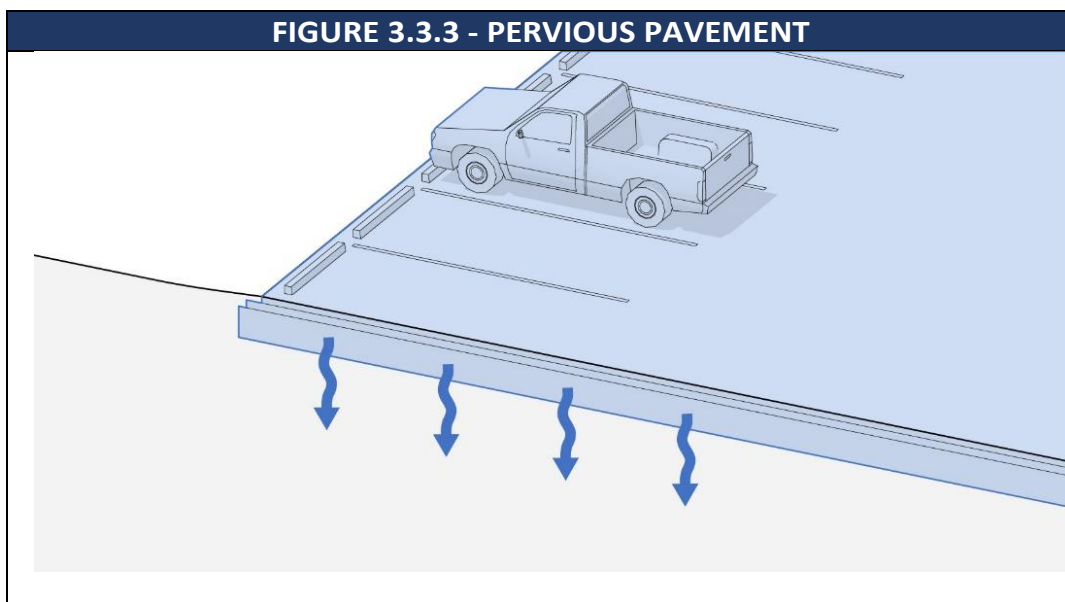

8. Subsurface Retention Facilities (Stormwater Vaults). Subsurface retention facilities are typically constructed below parking lots (either permeable or impervious) and can be built to any depth to retain, filter, infiltrate, and alter the runoff volume and timing. This practice is well suited to higher density sites with open space constraints. Subsurface facilities can provide a considerable amount of runoff storage. The water is filtered through the stone aggregate and infiltrates into the ground. An alternative strategy is to construct the subsurface facility with a filtering and pumping mechanism so that collected water can be reused for non-potable uses such as irrigation or flushing of toilets. Similar techniques include gravel storage galleries, sand filters, infiltration basins, and infiltration trenches (for areas with space constraints).

9. Green Streets and Stormwater Planters. Green streets are thoroughfares that capture, temporarily store, and treat road runoff at its source by incorporating vegetated water catchment and filtration devices in the form of small rain gardens and bioretention systems. Components such as flow-through planters and other sustainable storm water solutions allow stormwater from the street to enter planters through cuts in the curb where the plant material removes impurities and allows water to naturally infiltrate or be stored elsewhere. Water-loving plants and those that are able to remove the impurities while thriving so close to traffic and in more urban environments are used in green street design, adding beauty and function. Additional infiltration can be achieved using pervious paving materials for sidewalks and streets.



10. Downspout Redirection. Building downspouts are commonly directly connected to centralized sewer or stormwater systems. A LID design application is to redirect roof runoff onto pervious surfaces, most commonly a lawn. This simple act reduces the amount of directly connected impervious area in a drainage area.
11. Rain Barrels/Cisterns. Rain barrels should be placed outside of a building at roof downspouts to collect and store rooftop runoff, which can later be reused for lawn and garden watering.
12. Green Walls and Roofs. Green Roofs capture rainwater on the roofs of buildings to support plantings that reuse the water, reducing the overall amount of runoff leaving the roof. The plants and the soil they are growing in provide additional insulation for the building. Roof drains should be recharged into the site with the use of structural and/or non-structural low impact development drainage systems. Green Walls should be

designed to provide habitat, mitigate afternoon and seasonal heat gain, and re-introducing indigenous plants to the site.

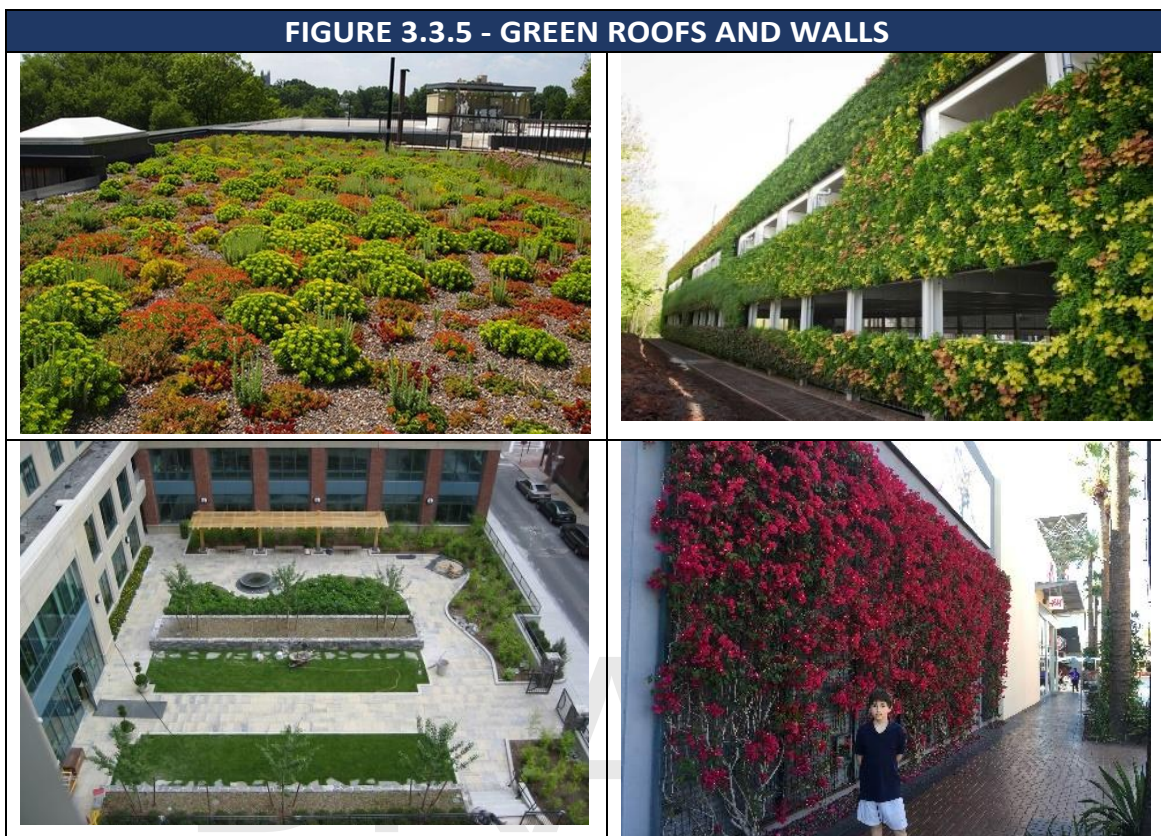

3.4 NATURAL LANDSCAPING

A. Intent. To protect water quality in Winchendon through natural landscaping and best practices in pavement management and infiltration.

B. General Requirements.

1. To the greatest extent possible, existing native trees and shrubs (vegetation that grows naturally in particular climates or regions) shall be maintained.
2. No tree, shrub or plant shall be used that has been identified as an Invasive Species by the Massachusetts Plant Advisory Group in the most recent version of *The Evaluation of Non-Native Plant Species for Invasiveness in Massachusetts* (with annotated list,) or has been identified as invasive or banned on the *Massachusetts Prohibited Plant List* as periodically updated by the Massachusetts Department of Agriculture.
3. Existing invasive plants shall be removed.

C. Natural Landscaping.

1. Natural landscaping with plants native to local climate and soil conditions are required. These plants thrive naturally, requiring less maintenance and irrigation than most hybrid or imported varieties.
2. Natural landscaping should be used to minimize the need for irrigation systems and improve planting longevity. Preserving existing wooded areas, mature trees, and natural terrain can give new development a premium "mature landscape" appearance and provide residents with additional recreational amenities.
3. Plant materials should be selected for their form, color, and texture, as well as solar, soil, and moisture requirements. It is also recommended that native plants be used because of their performance, site enhancement, and life-cycle cost benefits.

D. Canopy and Shade Trees. The broad use of canopy trees is a simple and attractive solution to reducing heating and cooling needs for buildings and sites. When planted on the south and west sides of buildings, shade trees keep buildings cool in summer and then drop their leaves during the cooler fall season allowing warming sunlight on buildings. Canopy trees also provide sunlight on parking lots in the winter and shade in the summer while absorbing rainfall which reduces the amount of stormwater.

E. Treatments. The use of fertilizer is discouraged.

F. Infiltration on Recreational Spaces. This form of bio-retention allows rainwater to be temporarily captured and stored for a short time, cleaning storm water runoff before infiltration. Public and private parks and open spaces should function as part of the stormwater system where applicable. Surrounding areas can be graded so that the rainwater flows towards the parks. Creating a gradual and imperceptible depression allows water to collect in the park and stay there long enough to infiltrate without giving the appearance of a stormwater facility that should store water for no more than 24 hours.

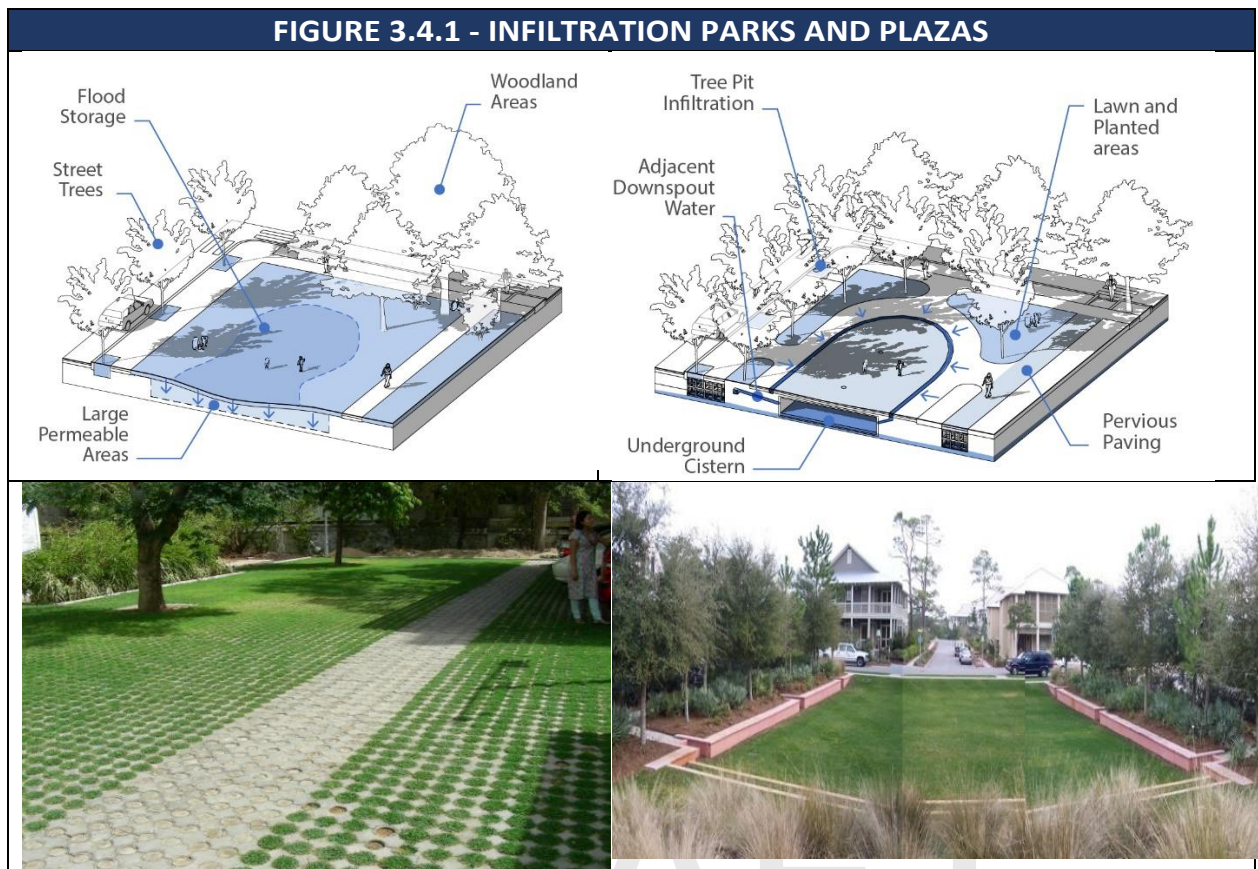

G. Tree Preservation. Preservation of existing, on-site trees and other vegetation is the preferred means for landscaping. Mature, healthy trees and vegetation may be used to fulfill landscape requirements of the **Zoning Bylaw, Article XXX**. Existing trees may be counted as required trees provided that:

1. The tree is at least four (4) inches in diameter at breast height (DBH).
2. The tree is determined to be in good health and not damaged, diseased, or a threat to public health or safety.
3. Invasive plant species to the State of Massachusetts must be removed from the site.

H. Local Food Production. To support conservation, self-sufficiency, improved nutrition, and reduced food expenses, the Town of Winchendon encourages small scale agriculture to strengthen the local food system. Some techniques include the following:

1. **Community Gardens:** See Outdoor Amenity Spaces in **Section XXX**.
2. **Edible Landscapes:** The utilization of plants and landscaping that produce edible food in settings that conventionally have been limited to ornamental or nonfood producing plants.

I. Installation of Landscape Materials.

1. **Plant Species:** Landscape should consist primarily of native species requiring minimal irrigation, fertilization, and maintenance. Plantings must be cold hardy, drought tolerant, and able to survive on natural rainfall once established with no loss of health.
2. **Planting Areas:** Must have uncompacted coarse loam that is a minimum of twelve (12) inches deep. Soils must be appreciably free of gravel, stones, rubble, or trash. All compacted soil, contaminated soil, or road base fill must be removed.
3. **Spacing:** The spacing and placement of plants must be adequate and appropriate for the typical size, shape, and habit of the plant species at maturity.
4. **Minimum Cover:** A minimum of two (2) kinds of landscape cover is required, including but not limited to trees, shrubs, permeable and pervious pavers, and turf grass.
5. **Ground Stabilization:** Bare and exposed ground on a site and/or in required landscaped areas must be stabilized and maintained with turf grass, ground cover, or mulch to prevent soil erosion and allow water infiltration, with the exception of the following:
 - a) Land area dedicated to urban agricultural activities, as permitted;
 - b) Trails;
 - c) Naturally occurring stream beds, rock outcroppings, and similar features typically lacking in vegetation; and
 - d) Clay or sand surfaces associated with recreation fields and facilities.

3.5 EFFICIENT PARKING AND ACCESS

- A. Intent.** In addition to **Article 8** of the Winchendon Zoning Bylaws, these parking standards provide best practice alternatives that the Planning Board may consider when granting site plan approval or parking waivers for placement and number of spaces to the requirements under Article 8, with the following intent:
1. To minimize the impact of sidewalk interruptions and conflict points on the walkability of the public realm.
 2. To ensure adequate parking for existing and new development while minimizing excessive and inefficient off-street parking lots that result in lost opportunities to develop new buildings that expand local business and the tax base.
 3. To encourage the use of public transportation, ride sharing, car sharing, bicycling, and walking as an alternative to personal motor vehicles when a choice of travel mode exists.

- B. Off-Street Parking Requirements.** Any parking spaces in excess of the given standards in **Section 8.4** is discouraged and the need for additional parking spaces must be clearly demonstrated.
- C. Parking Reduction Methods.** The Planning Board may grant a waiver for the reduction of off-street parking in the **Section 8.4 (ITE Parking Ratio Table is in the Appendices)** by employing one or more of the following best practices:
1. Shared Parking and Mixed Use.
 - a) A combination of uses on-site using shared parking lots with offset peak demand times where: a shared parking agreement with proximate properties where uses have offset peak demand times; uses have a high rate of parking turnover; or evidence of similar uses and location situations operating successfully with lower amounts of parking.
 - b) Where shared parking is proposed, the Planning Board may require an evaluation prepared by the applicant following the procedures of the Urban Land Institute (ULI) Shared Parking Manual (latest edition) or the Institute of Transportation Engineers (ITE) Shared Parking Guidelines (latest addition), or other approved procedures determined by the Planning Board.
 - c) A formal parking evaluation may be waived for small developments where there is established experience with the land use mix and its impact is expected to be minimal.
 2. Car-Sharing Program. The Planning Board may approve a parking reduction where an active car-sharing program is made available to residents and/or employees of a development site; and where the car-share facility is on site or within a 700-foot walking distance of the site.
 3. Off-Site Parking. The Planning Board may allow required parking to be provided off-site for employees, except for any required handicapped parking, as permitted according to the provisions of and when conforming to the following:
 - a) A lot featuring the off-site parking must be located within seven hundred (700) feet in walking distance, measured from the nearest point of the off-site parking along walkways to the principal building entrance served;
 - b) Pedestrian access between the use and the off-site accessory parking area must be via paved sidewalk or walkways; and

- c) A lease, recorded covenant, or other comparable legal instrument, executed and filed with the Town of Winchendon, guaranteeing long term use of the site is provided to the Planning Board.

D. Special Parking Types and Standards.

1. Stacked and Valet Parking. The Planning Board may grant a waiver to allow valet or stacked parking if an attendant is present to move vehicles. If stacked parking is used for required parking spaces, a written guarantee must be filed with the Town ensuring that an attendant will always be present when the lot is in operation. The requirements for minimum or maximum spaces continue to apply for stacked parking. Valet and stacked parking spaces do not require individual striping and may be permitted on-site or off-site as a means of satisfying the applicable off-street parking requirements where:
 - a) Adequate assurance of the continued operation of the valet parking is provided.
 - b) An equivalent number of valet spaces are available to replace the number of required off-street parking spaces.
 - c) The design of the valet parking area will not cause queuing in a vehicular travel lane.
 - d) An attendant is provided to park vehicles during business hours.
2. Tandem Parking. The Planning Board may grant a waiver to allow tandem parking under the following conditions:
 - a) To be used to meet parking requirements for residential units only.
 - b) Tandem spaces shall be assigned to the same dwelling unit.
 - c) Tandem parking shall not be used to provide guest parking.
 - d) Two parking spaces in tandem shall have a combined minimum dimension of 9 feet in width by 30 feet in length.
 - e) Up to 75% of the total off-street parking spaces provided may be incorporated into tandem parking.

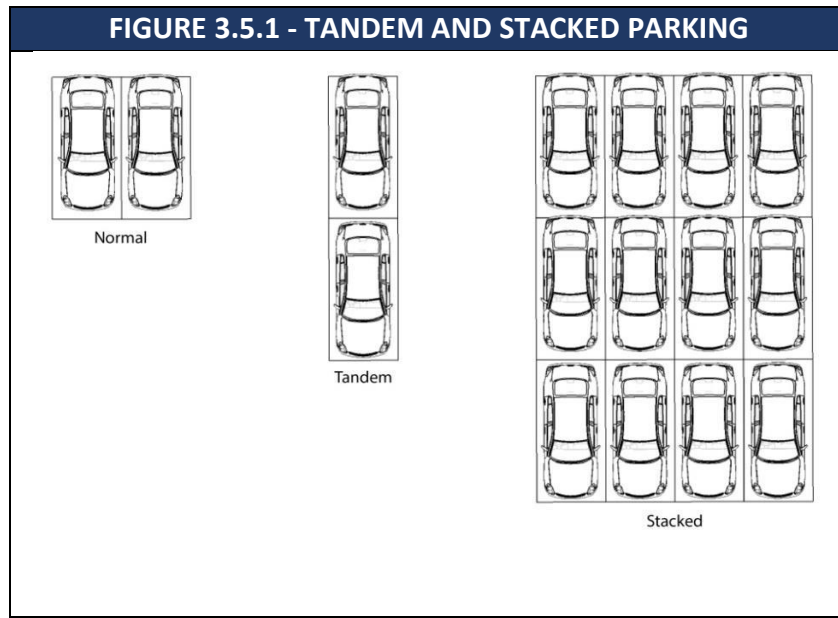

3. Street Side Parking. The Planning Board may grant a waiver to allow parallel parking provided on a privately-owned lot directly **fronting on Central Street and side streets between Front Street and Maple Street, an on Front Street from Lake Street and River Street** adjacent to the public right-of-way in combination with a minimum five (5) foot wide planting strip with street trees planted 40 feet on center, and eight (8) foot minimum concrete sidewalk connecting to public sidewalks on abutting lots and to the primary building on-site. These parking spaces shall be 8 feet wide by 22 feet long; accessible for public use; and effectively function as on-street parking.

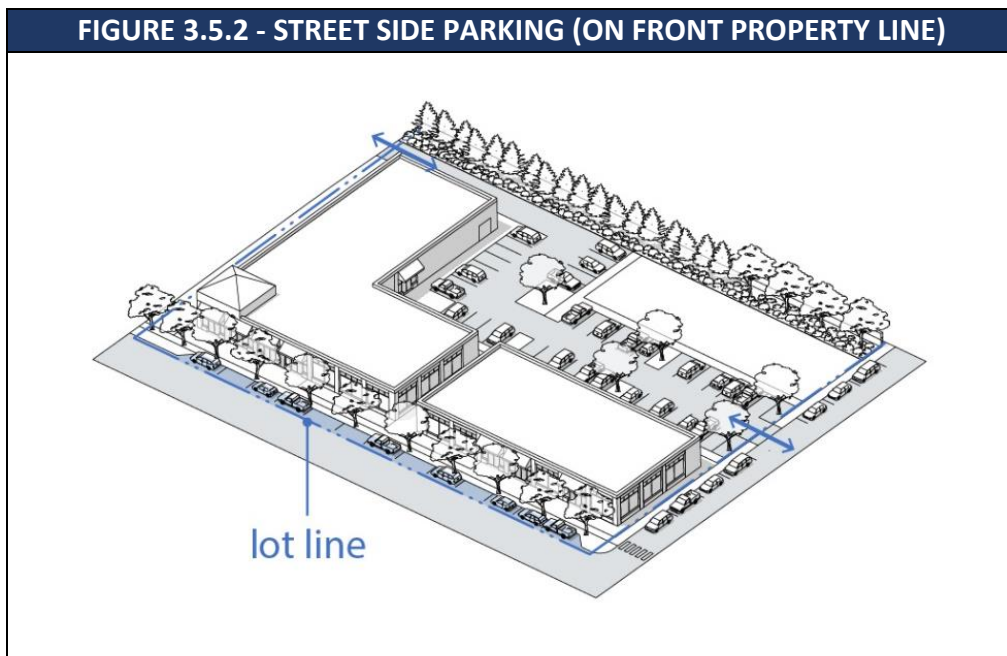

E. Surface Parking Design Standards.

1. Placement. Off-street parking lots should be placed to the side and rear of commercial, industrial, and mixed use buildings.
2. Pedestrian Access. Pedestrian access from a parking lot must connect directly to a public sidewalk and to the primary building.
3. Common Driveway. Shared driveway access from a public street to adjacent properties is permitted and encouraged wherever possible.
4. Shared Vehicle Access. Shared internal access and utilization of parking spaces on separate lots is permitted and encouraged.
5. Pervious Materials. Off-street parking lots may be surfaced with pervious materials to allow stormwater to permeate the ground below. See Section 3.3 above.

FIGURE 3.5.3 - EXAMPLES OF WELL LANDSCAPES PARKING LOTS AND SHADE TREES



F. Structured Parking Standards.

1. Permitted Types. Off-street parking structures may include a surface garage or carport, an above-ground parking structure, or an underground parking structure.

FIGURE 3.5.4 - EXAMPLES OF STRUCTURED PARKING AND FRONTAGE UTILIZATION

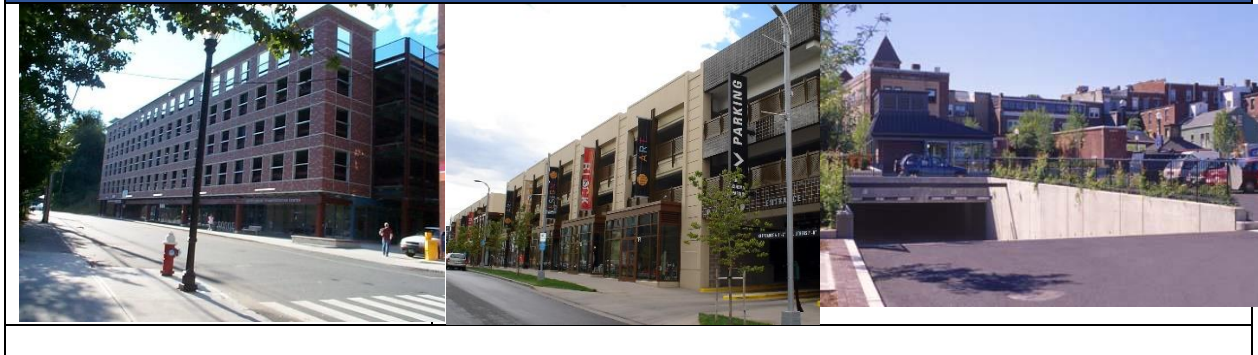

2. **Access.** Pedestrian access to structured parking shall be made directly to the primary building and to a public sidewalk as applicable. Structured parking may be attached directly to the primary building allowing pedestrians to enter directly into the building. Parking structures may be shared by multiple properties to meet off street parking requirements.
 3. **Design and Construction.** Where a structured parking facility is visible from a public street, the design of the visible façade(s) must be meet the follow standards:
 - a) Facade door and window openings must be vertically and horizontally aligned and all floors on the front side of facade facing the street must be level (not inclined).
 - b) The facade must include windows of transparent or translucent, but non-reflective, glass or openings designed to appear as windows for between twenty percent (20%) and fifty percent (50%) of the wall area of each floor.
 - c) Windows must be back-lit during evening hours and internal light sources must be concealed from view from public sidewalks.
 - d) The facade area masking the floors occupied by motor vehicle parking must be seamlessly integrated into the architectural design of the building's facade.
 4. **Commercial Use.** The ground level and top level may be used for commercial purposes.
- G. Access.** Driveways serving 2 or less dwelling units shall be a maximum of 16 feet in width but may be increased or reduced with the approval of the Planning Board. Driveways serving commercial, industrial, civic, mixed use, and multifamily buildings and development shall be no greater than 24 feet in width. The Planning Board may grant waivers for driveway widths when pervious surfaces are being used.
- H. Parking Waiver Criteria.** Where a waiver is sought for relief from the parking standards, the Planning Board shall consider the following:
1. The supply and demand of public and private parking in the district, as determined through a parking study.
 2. Transportation and mobility management programs and services provided by the applicant to reduce the demand for parking.
 3. That parking provided in excess of the minimum requirement does not result in underutilized spaces, excessive impervious surfaces, and lost opportunities for building or outdoor amenities spaces.

4.0 RESIDENTIAL DEVELOPMENT FORMS AND BUILDING TYPES

4.1. APPLICABILITY

These design standards are applicable to residential developments under the Winchendon Zoning Bylaw including Article 11 - Residential Development. These design standards are also intended to guide municipally sponsored residential development, Chapter 40B Comprehensive Permits, and other residential developments sponsored by non-profit housing and community development organizations.

4.2. PRINCIPLES IN PRACTICE

The design and development of new high quality residential communities is a goal of the Town of Winchendon. The combination of a sustainable site layout, quality building design, and active outdoor amenity spaces creates a vibrant residential community that is a benefit to residents and provides a competitive advantage in the market. These residential development and design standards provide specific recommendations for larger scale residential development, and residential uses that require a Special Permit or approval at Town Meeting with the intention of reinforcing the traditional New England community character of Winchendon. For applicable residential developments, the following principles apply:

- A. Development site composition that reinforces the human scale of the built environment with buildings that are relatable to the pedestrian and a walkable site design with inviting streetscapes or small community open spaces for socializing and gathering.
- B. Building architecture that is varied and eclectic in style that echoes traditional New England design characteristics with traditional details, materials, and colors.
- C. Cluster smaller residential buildings together on smaller lots and around common space, while preserving larger contiguous tracts of open space.
- D. Arrangement of larger buildings around a common open space that is framed by paths, small streets, or natural landscapes.
- E. For larger buildings, employment of additive building massing that suggests evolution or modification over time through organic, incremental growth. For example, the classic New England connected farmhouse.

4.3. GENERAL SITE IMPROVEMENT STANDARDS

The following guidelines outline the site design and layout practices that should be viewed as baseline components of a well-designed residential development in the Town of Winchendon.

- A. **Site Composition.** A residential development's site planning and design should provide a responsive approach to the natural conditions of the land and adapt the development program and site elements to the attributes and constraints of the property.

1. Cluster Arrangement. Site design should be used to reinforce the sense of a New England village environment with clustered buildings that reinforce a sense of community.
2. Frame Views and Spaces. Site and building layouts should frame purposeful clearings, enhance desirable views and reinforce privacy between residential buildings.
3. Integrate Natural Site Features. The site design should take advantage of the natural site features by maintaining, incorporating, or adapting the inherent characteristics of the property (topography, landscape features and vegetation, rock formations, stone walls, etc.) to guide and benefit the layout and design of the site.
4. Create Compact Development Footprint. Site and building components should be clustered to maintain the maximum amount of natural and undisturbed open space on the property. Natural site features, such as mature trees, groves, and woodland buffers, should be retained as part of the residential development to benefit the site layout and surrounding community.
5. Reduce Impact of Parking. Site layout should be designed to minimize the visibility and impact of parking, service, and utility-oriented functions of the property. Parking should be provided in smaller areas distributed among residential buildings and by means of on-street parking or parking in driveways.
6. Share Open Space. Use common open space as a design feature in the layout of building clusters.

FIGURE 4.3.1 – ILLUSTRATIVE EXAMPLES OF SITE COMPOSITION



- B. Building Orientation.** For larger-scale residential development, buildings should be used to organize the site, reinforce a sense of neighborhood, frame open space, and conceal parking and service areas.
1. Orient Building to Street and Open Space. Primary building facades should be oriented to the street frontages and/or common open spaces that in turn are bordered by

development streets. An alternative pattern is to provide access streets to the rear of the building and frontages would be directly onto a common pathway and open space.

2. Relate Buildings to Each Other. A development that includes multiple residential buildings should orient the buildings to address each other and to frame street frontages and common open spaces.
3. Respect Patterns of Context. Building setbacks should be consistent with the design standards in Section 4.5 Residential Building Design and consider the pattern of buildings in the context of the surrounding residential community. Where there are adjacent buildings, the setbacks should be similar to reinforce the rhythm and pattern of the neighborhood.
4. Vary Building Relationships. Variation between buildings and the manner in which they frame open spaces should occur to create distinct relationships between buildings and common open spaces.
5. Conceal Parking with Buildings. Buildings should be oriented so that surface parking and garages are concealed in secondary locations and are not the primary visual focus of the development.

FIGURE 4.3.2 – ILLUSTRATIVE EXAMPLES OF BUILDING ORIENTATION



C. Site Access. Site access should provide clear and legible routes for all modes of transportation including pedestrians, bicycles, vehicles, and public transportation where available. These “Complete Streets” should connect to the site to the public street system, and internal site circulation systems.

1. Minimize Site Access. The number and width of vehicular access points into and out of the site should be minimized. Pedestrian crossings should be marked and differentiated with variations in paving materials such as stamped concrete or painted asphalt. Refer to the Chapter 175 - Winchendon Subdivision Regulations and the Department of Public Works for additional requirements as part of the street permitting process.

2. Connect to Public Frontages. Sidewalks or pathways should be provided along any and all internal street frontages and along the site perimeter frontages. Additionally, sidewalk and paths should be provided linking street frontages to all building entries.

D. Internal Site Circulation. Circulation internal to the site should provide clear and legible routes for all modes of transportation to connect to the streets, building entries, and other site components.

1. Complete Circulation System. A complete access system for all modes of transportation, pedestrians, bicycles and vehicles, should be integrated into the site design. The vehicular street network should provide connecting routes between adjacent parcels as appropriate to enhance connectivity within the Town.
2. Promote Pedestrian Circulation. Internal site vehicular circulation routes should be designed with traffic calming, such as narrow travel lanes and marked pedestrian crossings, to slow vehicular traveling speeds and reinforce a safe and welcoming pedestrian environment. Pedestrian crossings should be marked and differentiated with variations in paving materials such as stamped concrete or painted asphalt.
3. Enhance Pedestrian Connectivity. Sidewalks should be provided along all street frontages at the site perimeter. Sidewalk paths should be provided on new streets within the site, linking public frontage street(s) to building entries. Existing footpaths on the site should be accommodated and integrated into the site circulation to provide access across or through the site. Site circulation that contributions to connectivity of existing trail systems (i.e. Winchendon Rail Trail and others) should be integrated into the site access and circulation and be a part of the residential community amenities.
4. Integrate Bicycle Circulation and Connections. Access, circulation, and safety for cyclists on site including pathways, pavement markings, bicycles racks near community amenity spaces and multifamily buildings, and other amenities.
5. Create Efficient Parking and Circulation. Shared driveways should be used for adjacent residences. Efficient parking and access configurations should be employed that minimize repetitious infrastructure and impervious surfaces. Clustered infrastructure and access should be used to reinforce clustered building patterns.



- E. Parking.** Parking should be conveniently near building entrances while maintaining pedestrian access, safety, and aesthetics of the site. Parking is necessary to support the function of a residential development, but it should not be viewed as utilitarian only. Parking should be integrated with other site amenities that support a sense of community. Specific parking requirements are in Article 8 of the Zoning Bylaw.
1. Minimize Parking Location and Orientation. For residential developments with a garages, the garage door should not be located on the primary building façade or street frontage. On secondary building facades, the location and design of garage doors should be integrated with the design of the façade so that the garage door is not the prominent feature of the façade.
 2. Distribute Parking Areas. Where feasible, parking areas should be distributed on the site in a central location or in multiple smaller parking areas for larger developments. Parking areas should be integrated within the building layout and site amenities to reduce the overall visual impact of parking on the residential community. Distributed parking areas should be located to the rear and side of buildings with access provided by primary streets or rear access streets.
 3. Create On-Street Parking in Pockets. On-street parking is encouraged in pockets and integrated within the overall site circulation and landscape plan. Information on-street parking may also be appropriate with wider streets. Where parking pockets are located near a residential building, they should be of a material other than asphalt to reinforce the appearance of a parking space.
 4. Provide Visitor Parking. Visitor parking should be provided for a residential development beyond that required for unit parking. Visitor parking should be located in a central area convenient to most units or near common open space.

5. Reinforce Parking Screening. When adjacent to a common open space or residential building, parking should be screened from view through the use of trees, landscape beds, and/or low fences or stone walls.
6. Integrate Parking Landscape. Large parking areas should be broken into smaller areas by means of landscaped islands containing low plantings and deciduous trees. Such islands should be placed at regular intervals across the parking lot to reduce the visual impact of the parking area and to reinforce a more pleasant pedestrian environment.



F. Open Space. Residential development projects should provide common open space integrated within the overall site plan design. Several characteristics of this type of open space are important to the character and quality of the residential community. (See Section 6.0 - OUTDOOR AMENITY SPACES for specific types of Outdoor Amenity Spaces and design standards).

1. Define Public and Private Space. In a residential development creating clear and distinct boundaries between public space and private space is very important. This can be accomplished through the configuration of buildings, paths, fences, and landscape.

2. Design Common Open Spaces and Amenities. In the context of the residential development, common open space, is open space that is shared by the residential community. It is an amenity and resource shared among residential units of the development but is not considered a public open space. Depending on the scale and use of the common open space, this area could include natural park areas, small pedestrian plazas, playgrounds, community gardens, outdoor seating, landscape, trails, community buildings, and other amenities.
 3. Create Private Open Space. In addition to common open space, private open space should also be provided in a residential development. These spaces would be dedicated for use by a single unit with clear boundaries and potentially associated with ownership, leases or deed restrictions. Private open spaces could include yards, gardens, greenhouses, patios, terraces, decks, porches, balconies, and other amenities.
 4. Consider Public Open Space. Different from a common open space, a Public Open Space would be accessible to the public for community use beyond the residential development.
 5. Create Open Space Connections. Common or Public open spaces should also link to existing or proposed trails or pathways in and around the property, creating a network of connected open spaces and walking routes.
- G. Site Furnishings.** Site furnishings should enhance community activity and serve to enhance the resident's experience. Site furnishing may include benches, trash and recycling receptacles, bike racks, fire pits, picnic benches and shelters, gazebos, playground equipment, exercise stations, and other components appropriate to the use and scale of the development.
1. Coordinate Location of Furnishings. Site and open space furnishings should be located as appropriate to level of activity and site use in higher activity areas that are most likely to receive use.
 2. Coordinate Design of Furnishings. The character and design of the site amenities selected should be consistent with the overall character of the site and building design.
 3. Integrate Furnishings. Site amenities should be integrated with the site design to allow appropriate clearances, space, and circulation around them to allow busy areas to function appropriately.
- H. Landscape and Streetscape.** Residential development should include a hierarchy of landscape that contributes to the overall site design and integrates with adjacent properties as applicable. Refer to the **required list of species in Section XXX of the Site Plan Rules and Regulations that are drought tolerant, native to New England, and non-invasive**).
1. Define Entry and Gateway Landscape. Entry and gateway landscape should be used to define site access and reinforce a sense of arrival to the residential community. The

gateway landscape may be integrated with signage throughout the residential development. This type of feature should be simple and balanced within the overall development.

2. Integrate General Site Landscape. Development site landscape should be used to provide privacy, frame views, and reinforce a sense of New England character by defining edges and clearings.
3. Coordinate Scale of Landscape. Selection of the type and maturity of plantings should be carefully considered relative to the overall scale of the development and individual buildings. New plantings should be selected for reasonable maturity at the time of installation to achieve a more rapid appearance of fullness.
4. Define Building Landscape. Building landscape should be used to integrate the buildings into the overall site plan, soften building edges, and enhance public sidewalks, building entries, and any common open spaces and community buildings.
5. Create a Layered Landscape. Building landscape should be used to establish zones of privacy for residential units with a pattern of plantings and landscape design that reinforces the interconnectivity between streets, buildings, private open spaces, and common spaces.
6. Highlight Featured Spaces. At locations that are significant in the overall site design such as community amenities, the landscape should be used to reinforce the importance of this site component. An additional number of plantings, unique composition or variation in planting species, scale, or plant species with special seasonal variation should be used to reinforce common site features.
7. Provide Landscape Screening and Buffers. Landscape should be used to integrate and conceal dumpsters, recycling areas, and other equipment or service uses from view by residential units or pedestrian areas. Additional landscape buffering should be provided where the property abuts another type of use to reinforce the distinction between the properties.
8. Coordinate Landscape at Street Frontages. Streetscape for site frontages on public or private ways should contribute to the character of the community and reinforce a consistent street context that is integrated within the character, type and spacing of adjacent landscape improvements. A tree belt should be located on both sides of the street separating the travel lanes from the sidewalk, and deciduous street trees should be planted in a regular pattern. Where applicable, the center of cul-de-sacs should also be landscaped with a combination of trees and landscape beds. The landscaping along public street frontages should respect and reflect the character of Scenic Roads where designated.
9. Integrate Functional Features into the Landscape. Stormwater retention areas should be integrated within the site landscape and treated as a naturalized environment.

These site features should be sustainable from a plant material and maintenance perspective. Retaining walls, fencing, guardrails and other utilitarian or screening features should be integrated with the overall landscape design and contribute to the overall site character. Functional site features should be designed, and consideration should be given to views from adjacent properties.

10. Integrate Functional Features and Materials. The materials used for functional features, such as retaining walls, drainage structures or other required site elements, should be integrated within the overall site design and material palette. For example, a functional retaining wall should include stone facing to reflect the traditional New England Character of the town.



- I. **Transitional Buffers.** Along the perimeter of the lot or development tract abutting residentially zoned and occupied properties, the Planning Board may determine that certain buildings and uses may need to be buffered to create a compatible transition with the surrounding neighborhoods.
 1. Landscape Buffer. Where required, buffers may include a combination of natural or landscaped screening and fencing that provides an opaque visual barrier to a minimum height of six (6) feet above the ground.

2. **Building Buffers.** Where required, primary residential and mixed use building height at the side or rear yard setback line should be 25 feet with increasing height permitted on a 45-degree plane further setback from the tract boundary to the maximum height allowed by the Building Type.

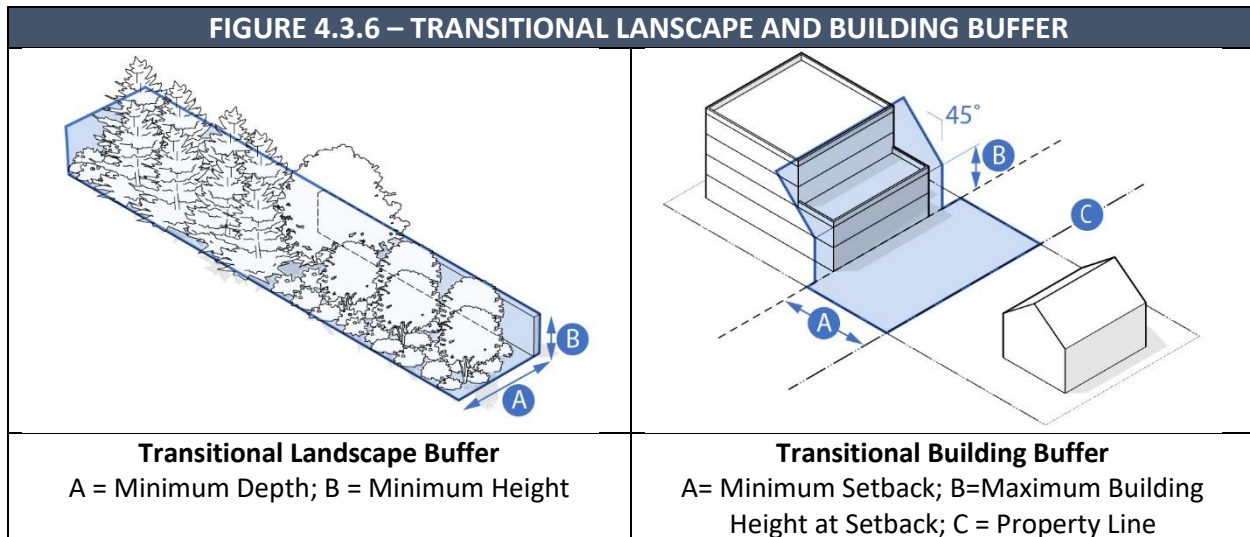

- J. Site Lighting.** Site lighting is intended to provide safety in areas with evening activity, particularly near street and building entries, across parking lots, and on paths and open spaces. The minimum level of lighting for nighttime safety should be provided. Lighting design must comply with the requirements in Section 135-5.4 of the Zoning Bylaws.
1. **Minimize Lighting.** Site lighting must meet the minimum lighting standards but not provide lighting in excess of requirements. Downward-directed, dark-sky compliant lighting should be provided to minimize excess glare and spillage off the development site.
 2. **Integrate Lighting Fixtures within the Overall Design.** Lighting fixtures should be selected to contribute to the overall character of the streets, buildings, and consistent with the overall design and sense of community.
 3. **Create Multiple Layers of Site Lighting.** Site lighting should perform multiple functions for multiple areas and users. Site lighting should be designed for vehicles, pedestrians, building entry areas, and site features. Each of these multiple areas should be designed in coordination and to complement the overall character of the site.
 4. **Define Entry, Gateway and Feature Lighting.** Site lighting that is highlighting a specific site element should be confined to that site element. Such lighting should be used in the foreground of element to accent the feature such as a sign, a wall, landscape plantings, or other feature.

4.4 RESIDENTIAL DEVELOPMENT FORMS AND PATTERNS

A. Purpose.

1. To promote greater diversity and affordability of housing opportunities to meet the needs of a diverse population with respect to income; disability and accessibility needs; size of household; and stage of life.
2. To provide incentives for the creation of modestly sized market rate housing units and affordable housing units in accordance with the goals of the Winchendon Comprehensive Master Plan and Housing Production Plan, recognizing the Town's moral and practical obligation to contribute to a balanced housing stock for all its residents.
3. To promote better access between housing and public transportation, shops, services, and employment.
4. To encourage less sprawling and more efficient forms of development as an alternative to conventional subdivisions, so as to consume less land, preserve open space, and conform to existing topography and natural features.
5. To encourage the use of sustainable building techniques and universal design.
6. To sustain Winchendon's cultural and historical values and to facilitate contextual development that preserves historically or architecturally significant buildings and landscapes, as well as traditional patterns of land use and neighborhood development.
7. Recognizing that not all of the stated purposes can be achieved in every development and every location, to nonetheless consider each carefully in approving new developments and to be mindful of the need to further these goals across the Town over time.

B. Conventional Residential Development Type (CRD). This form of development is allowed by right with approval of the Planning Board and is designed to comply with Zoning Bylaw in terms of land use, dimensional standards, and intensity standards and the requirements of the Subdivision Regulations.

C. Diversified Residential Development Types (DRD). These forms of development are allowed by special permit from the Planning Board and may provide for a mix of residential building types and selected non-residential uses compatible with and supportive of the residential development. A DRD may also allow organized groups of households to construct residential units and common facilities for their collective and individual ownership and use. It is intended that a DRD be flexible in nature and allow for modification of lot size, size or type of dwellings, density, and required open space in the regulations of

the underlying zoning district, so as to result in patterns of land use that are more compact and more efficiently laid out on a smaller site.

FIGURE 4.4.1 - EXAMPLE OF CONVENTIONAL AND DIVERSIFIED RESIDENTIAL DEVELOPMENT

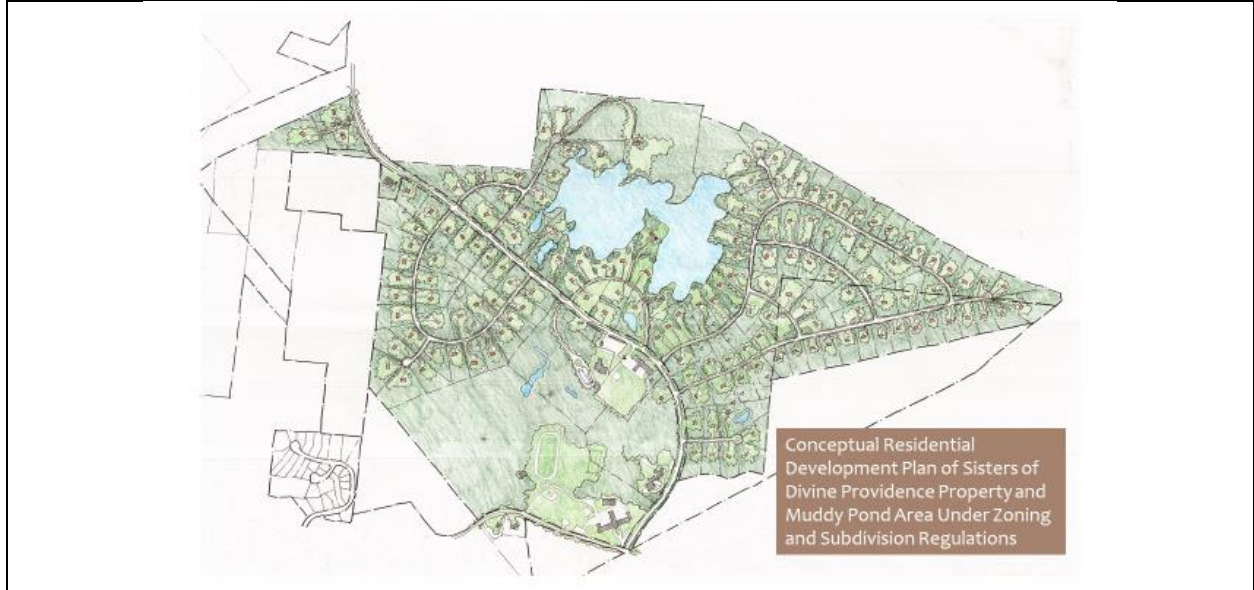

Example of parcel of land subdivided under Conventional Residential Development



Example of parcel of land designed as a Diversified Residential Development with neighborhood scale housing, small village center, and integrated open spaces

The types of DRDs allowed by special permit from the Planning Board are defined below and development standards are provided in **Figure XXX:**

1. Open Space Residential Development (OSRD). A residential development where preservation of natural features such as forested slopes, ravines, ridges, wetlands, and other natural attributes and constraints are prioritized in the location and configuration of residential buildings within a tract of land. OSRDs typically cluster residential units to preserve natural resources as well as to provide open space for active and passive recreational uses. OSRD may also include the preservation and continued operation of existing farms. This form of OSRD (so called “agri-hoods”) may provide a revenue source to preserve the viability of the existing farm while the residential units support the farm operation and provides added value to the residences. OSRDs are allowed by right from the Planning Board when consistent with the density requirement of the underlying zoning district and by special permit is a density bonus is sought by the applicant.

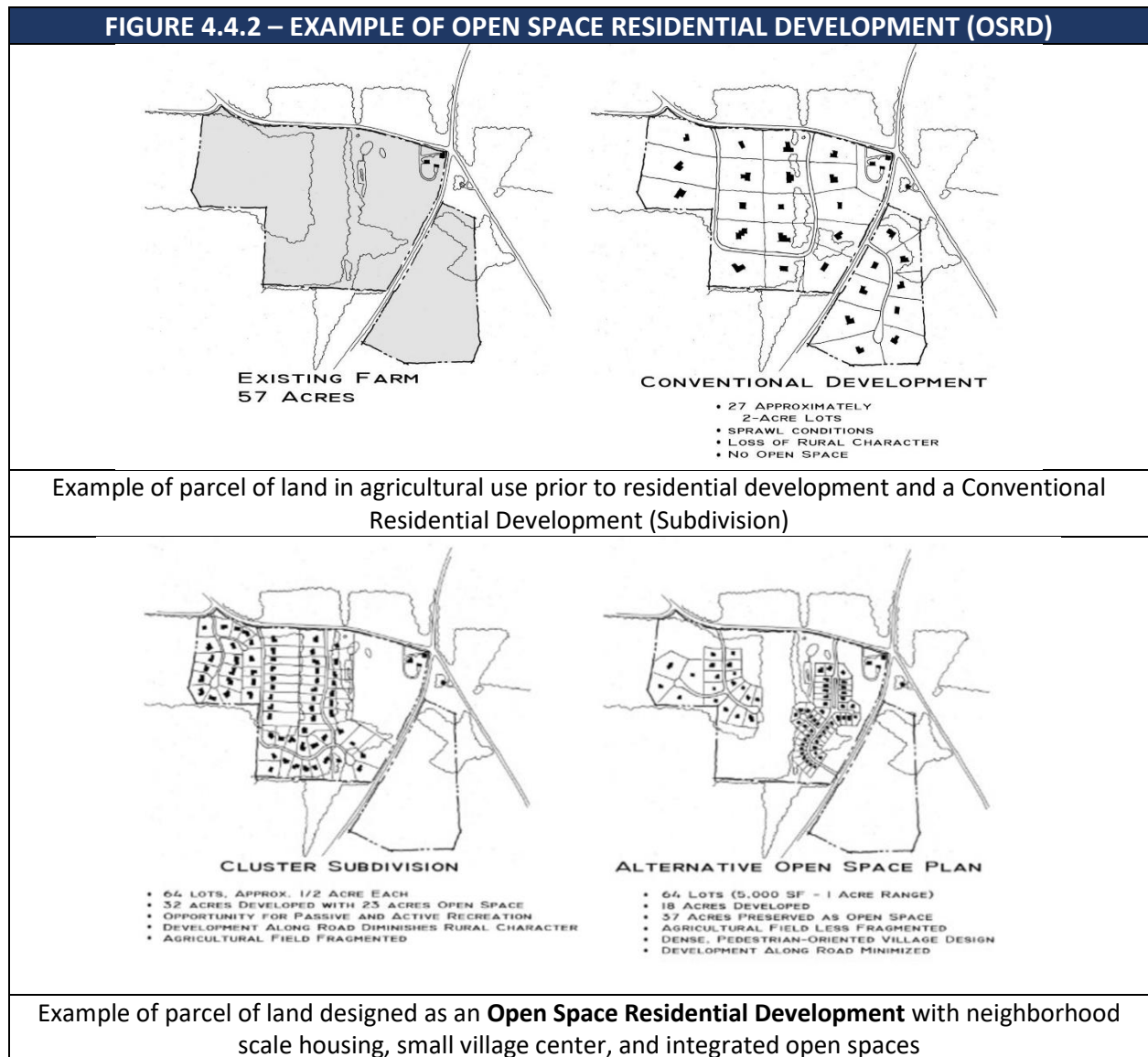

2. Compact Neighborhood Development (CND). There are three (3) types of compact neighborhood developments allowed in Winchendon with design and development standards provided below:

a) Cottage Court Development (CND-CC). A community of small detached or semi-attached residential buildings with narrow frontages arranged around and oriented to a common open space which becomes an important community-enhancing element of the neighborhood. Cottage Courts typically have a network of pedestrian walkways to provide connectivity within the neighborhood while maintaining personal privacy. Cottage Courts may also have shared common facilities such as community garden plots and accessory civic buildings and facilities that support the neighborhood and provide opportunities for residents to gather. Vehicle access is typically located behind the residential units and parking is typically located behind the residential units or in a central location.



- b) ***Traditional Neighborhood Development (CND-TND)***. A type of Compact Neighborhood Development which may include a variety of residential building types with narrow frontages and oriented toward a network of streets, sidewalks, and common open spaces that provide active and passive recreation. TNDs have a network of pedestrian walkways to provide connectivity within the neighborhood and shared community open spaces and facilities. Vehicle access can be front loaded from a public or private street or behind the residential units from an alley.



- c) ***Cohousing Development (CND-CD)***. A type of Compact Neighborhood Development and community of small private homes clustered around shared buildings and common spaces. Each attached or detached residential unit has traditional amenities, including a private kitchen. Shared spaces typically include a common house, which may have a kitchen and dining area, laundry, and assembly spaces for all residents.

Other shared spaces may include community garden plots, recreational fields, parking courts, and shared work spaces.



3. Workforce House Infill Lot (WFH). The purpose of this section to is allow for the construction of an affordable and small detached single family residential unit on a lot with sufficient upland area and public utility services that does not comply with the minimum lot area and/or frontage requirements of the RO, RS, or RT zoning district. The Planning Board may issue a special permit for a Workforce House subject to the following requirements:

a) Eligible Infill Lots.

- 1) Pre-Existing Lot. A pre-existing vacant lot, including a lot held in common ownership with an adjoining lot, existed as of **January 1, 2022**.
- 2) Subdivision of Existing House Lot. A pre-existing house lot divided into two (2) separate house lots where the existing house lot remains in compliance with all dimensional requirements of the underlying zoning district and the

new infill lot meets the requirements of this section.

b) Minimum Dimensional Requirements.

- 1) In the **R80** zoning districts, the infill lot shall have a minimum of 40,000 square feet, a minimum of 40 feet of contiguous frontage on a public street, and 10,000 square feet of upland area.
- 2) In the **R40 and R20** zoning districts, the infill lot shall have a minimum of 20,000 square feet, a minimum of 40 feet of contiguous frontage on a public street, and 5,000 square feet of upland area.
- 3) The minimum front, side, and rear yards shall not be less than the required yards in the underlying zoning district.
- 4) A new workforce single-family home shall be located in a manner that allows its construction to meet the requirements of this section without needing an existing home to be demolished or relocated.

c) Number and Size of Units. An infill workforce house shall be a detached single-family home with **less than 3,000 square feet of gross floor area and no more than three (3) bedrooms.** No infill workforce house approved under this section shall be converted to a two-family or multi-family dwelling. The workforce housing unit may include one (1) accessory dwelling unit.

d) Affordability Requirement. An infill workforce house shall be rented or sold only to an eligible household with an income at or below **80% of the AMI.** The infill workforce house shall be subject to a permanent affordable housing deed restriction. The workforce house shall be eligible for inclusion in the Chapter 40B Subsidized Housing Inventory (SHI) and are subject to the standards in **Section XX of the Winchendon Planning Board Rules & Regulations (Fair Housing and Affordability Standards).**

e) Access. An infill lot shall have frontage on an existing public way or private way that provides safe and adequate access as determined by the Planning Board.

f) Utilities. All infill residential units shall connect to the public sewer and water system.

g) Parking. There shall be at least two (2) off-street parking spaces per infill residential unit. No parking shall be located nearer than ten (10) feet to the adjoining property line, and no parking shall be located in the front yard. Parking areas shall be suitably screened from abutting properties.

h) Further Subdivision. An infill lot approved under this section shall not be further subdivided, reduced in area, or changed in size or shape. It may be used only for one

infill workforce house and one accessory dwelling unit as provided herein.

4. Residential Compound Development (RCD). An existing single family home with no more than three (3) additional residential units may be allowed on a common parcel or tract and subject to the requirements of this Section. The purpose of a Residential Compound Development is to provide an alternative to conventional residential subdivisions by allowing for limited residential development on a parcel of land without requiring the construction of a new road for the purpose of promoting common lot development; reducing impacts of new development on abutting properties; reducing Town maintenance responsibility and costs for a public road; diversify housing options; and preserving the character of the surrounding area. The Planning Board may grant a special permit for a Residential Compound Development in the R80, R40, and R10 districts subject to the following requirements:
 - a) Scale of Development and Permitted Standards. A Residential Compound Development shall consist of a combination of single-family detached dwellings, two-family dwellings, and accessory dwelling units totaling no more than four (4) residential units on a lot or commonly owned lots and accessed by a private access road or driveway.
 - b) Frontage. Frontage may be provided on a single parcel or tract of land held in common ownership, which has the minimum required continuous feet of frontage in the underlying zoning district on a public street or a private road that has been approved and constructed in accordance with the Winchendon Subdivision Regulations.
 - c) Minimum Parcel Size. The parcel or tract of land in common ownership shall contain at least 1.5 times the required minimum lot area in the underlying residential zoning district. Any land which, at the time of submission of an application, is subject to a perpetual restriction, such as the conservation, preservation, agricultural preservation, or watershed preservation restrictions described in Massachusetts General Laws, Chapter 184, Section 31 or any other restriction similar thereto, shall not be included in the minimum lot area.
 - d) Dimensional Requirements. Dimensional requirements on Table 7.2 in the Zoning Bylaw may be modified for best fit the site. All buildings shall be separated by minimum of 25 feet.
 - e) Minimum Perimeter Buffers. The minimum front yard, side yard, and rear yard requirements on Table 7.2 in the zoning district shall apply to the perimeter of the common parcel or tract. The Planning Board may require additional landscaping and screening treatments along the perimeter to ensure a sufficient buffer from adjoining

properties.

- f) Access. Each residential unit in the development shall have adequate and legally enforceable rights of access to a public street via a private access road or driveway with a minimum surface width of twenty-two (22) feet. The Planning Board may reduce the required width of the private access road by two (2) feet with the prior consent of the Town Engineer and Fire Chief.
- g) Open Space. Any land within the common parcel or tract not designated as residential building area shall be designated as common open space. Such land may be used for conservation, outdoor recreation and related facilities, preservation of scenic landscapes or historic structures, and agriculture subject to use restrictions in the underlying zoning district.
- h) Limitation on Further Development. No such common parcel or tract for which a special permit has been issued under this section may be further subdivided and a notation to this effect shall be shown on the site plan and recorded.

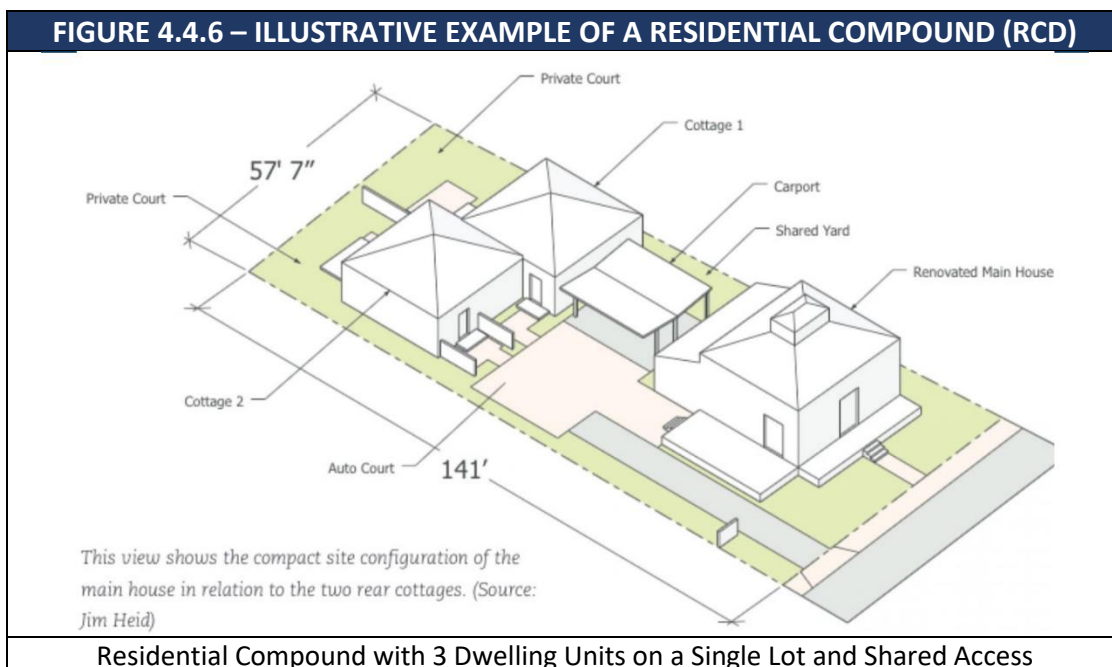

5. Residential Frontage Development (RFD). An RFD is an alternative to an Approval Not Required (ANR) subdivision consisting of a group of single-family detached dwellings or two-family dwellings combined for a total of no more than ten (10) residential units and sharing a common frontage road which shall meet the requirements for a minor street in Section XX of the Subdivision Regulations. The purpose of an RFD is to reduce impacts of new development on a public street vegetative buffer and abutting properties; reduce

curb cuts onto a public streets; expand housing choices and affordability; creates useful open space; and preserve the semi-rural character of the Town. The Planning Board may grant a special permit for a Residential Frontage Development in any residential district subject to the requirements below.

- a) General Standards. A Residential Frontage Development shall consist of a group of single-family detached dwellings and/or two-family dwellings. For every five (5) ANR building lots permitted under the requirements of **Section ANR** of the Subdivision Regulations, an additional building lot shall be permitted for a combined total of no more than ten (10) residential units sharing a common private access road.
- b) Residential Units and Dimensional Standards. Building lots may contain one (1) single-family detached dwellings with one (1) Accessory Dwelling Unit, or a Duplex but the total number of residential units in the development shall not exceed ten (10). Under this bylaw, the dimensional requirements regarding lot size, frontage, and setbacks for a two-family dwelling are the same as for a single-family detached residential unit in the underlying residential zoning district.
- c) Affordable Units. Residential Frontage Developments are required to create one (1) affordable residential unit for each eight (8) residential units in the development. All affordable dwelling units are subject to the requirements of **Section XXX (Affordable Housing Requirements)**.
- d) Access. Each residential lot shall have legally enforceable rights of access to a public street via a private frontage access road which meets the requirements for **Section XX of the Subdivision Regulations** except that the maximum surface width of the private access road shall be 20 feet. The Planning Board may allow a waiver of the width of a private access roads to no less than 18 feet or more than 24 feet with prior approval of the Town Engineer and Fire Chief. Each building lot shall have physical access over said private access road.
- e) Open Space. All land between the public street and the private frontage access road shall be designated as permanent common open space. Such land may be used only for conservation, outdoor recreational facilities of a noncommercial nature, agriculture, preservation of scenic or historic structures, and structures accessory to any of the above uses (including swimming pools, tennis courts, stables, greenhouses).
- f) Streetscape. If natural vegetation along the public street frontage is removed to allow for recreational uses on the common open space, deciduous trees shall be installed on a parallel line setback 10 feet from the public street right-of-way at 40 feet on center. At installation, the trees shall be 4 inches DBA. If a public sidewalk or private

pathway exists along the public street adjacent to the building lots, then the applicant shall install a similar facility along the entire frontage of the development consistent in width and materials as the adjacent sidewalk or pathway.

- g) *Proof Plan and Alternative Plan*. An application for a special permit from the Planning Board pursuant to a Residential Frontage Development shall submit an ANR subdivision proof plan meeting the requirements of **Section XX of the Subdivision Regulations** demonstrating and illustrating the number of building lots that can be created by right. The applicant shall also submit an alternate frontage development plan setting forth:

- 1) The layout of all building lots, the type of dwelling units, the private frontage access road, and common open spaces.
- 2) The details of all entrances and exits to and from the public street.
- 3) All proposed deed restrictions.
- 4) The proposed locations of all existing and proposed commonly owned structures;
- 5) The location and details of all existing and proposed utilities and proposed connections.
- 6) The existing and proposed easements or rights of way traversing or adjacent to the tract.
- 7) The boundaries, if any, of any area which the Conservation Commission has determined to be subject to Massachusetts General Laws, Chapter 131, Section 40.

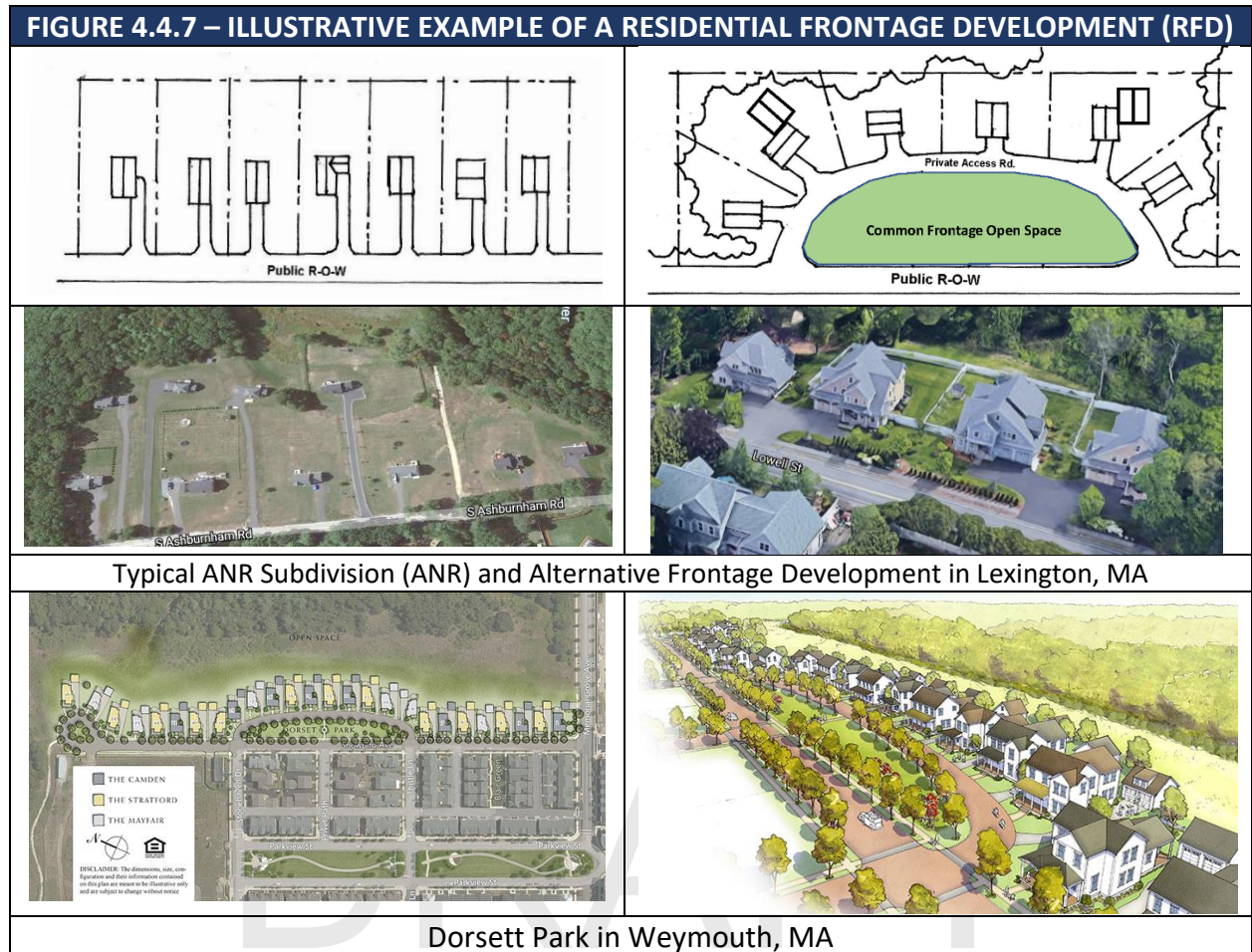

6. **Adaptive Reuse Residential Development (ARRD).** A special-condition housing development in which non-residential buildings are repurposed and rehabilitated for residential use such as agricultural buildings, publicly-owned buildings, religious and civic buildings, and commercial/industrial buildings. This type of diversified residential development is subject the following requirements:

- a) **General Requirements.** The Planning Board may authorize an existing non-residential structure, that was constructed at least 10 years prior to the date of application for approval of the special permit, to be converted to a residential use not otherwise permitted.
- b) **Site Development Plan.** The special permit shall incorporate by reference the building design and definitive site development plans filed with the application, and, where applicable, any legally binding documents that ensure the completion and continued availability of any proposed improvement or compliance with special permit conditions.
- c) **Special Permit Findings.** In order to grant a special permit, the Planning Board shall

determine that:

- 1) The structure can be modified for a residential use that does not have adverse impacts on the adjacent neighborhood;
- 2) The exterior character of the structure is maintained and is compatible with the adjacent neighborhood; and
- 3) Modification of the existing structure maintains more of the site as open space than the alternative of removal of the structure and further subdivision of the lot into individual house lots.

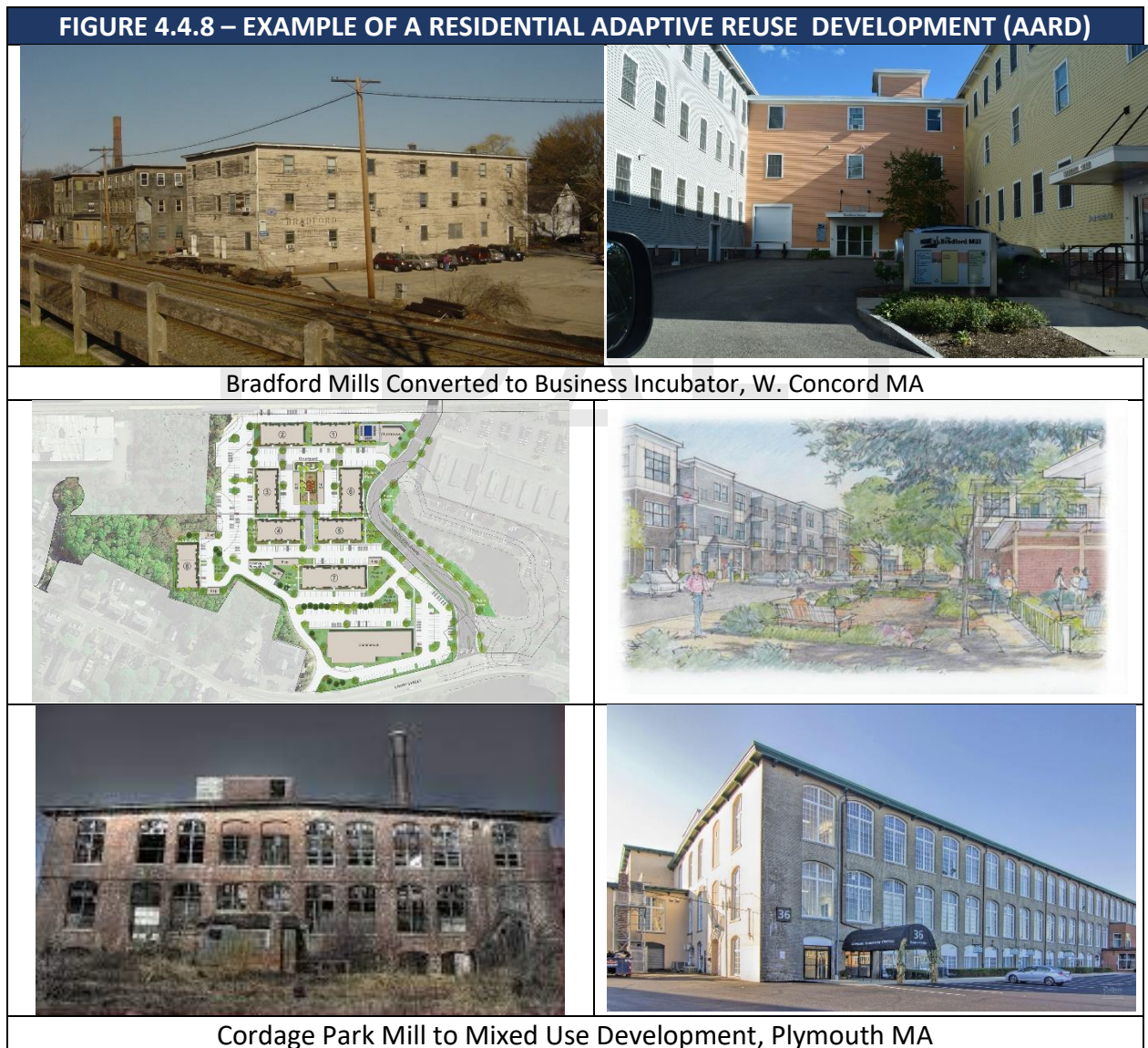

B. Compact Neighborhood Development Design Standards. CNDs should be consistent with the following development standards:

FIGURE 4.4.9 - OPEN SPACE RES. DEVELOPMENT & COMPACT NEIGHBORHOOD DEVELOPMENT STANDARDS					
		Open Space Community Development (OSCD)	Cottage Court (CND- CC)	Traditional Neighborhood Development (CND-TND)	Cohousing Development (CND-CD)
1.1. DEVELOPMENT STANDARDS					
A.	Tract Size (Min.)	80,000 S.F.	10,000 S.F.	40,000 S.F.	20,000 S.F.
B.	Tract - Public Street Frontage (Min.)	80 Ft.	40 Ft.	50 Ft.	50 Ft.
C.	Tract Perimeter - Front Setback (Min.)	50 Ft.	20 Ft.	20 Ft.	20 Ft.
D.	Tract Perimeter - Side Setback (Min.)	20 Ft.	15 Ft.	15 Ft.	15 Ft.
E.	Tract Perimeter - Rear Setback (Min.)	20 Ft.	15 Ft.	15 Ft.	15 Ft.
H.	Tract Impervious Surface (Max.)	25%	30%	30%`	30%
F.	Total Common Open Space (Min.)	33% of Tract	20% of Tract	20% of Tract	20% of Tract
G.	Total Outdoor Amenity Space (Min.)	15% of Tract	15% of Tract	15% of Tract	15% of Tract
1.2. PERMITTED BUILDING TYPES					
SEE SECTION 4.6					
1.3. PERMITTED OUTDOOR AMENITY SPACES					
SEE SECTION 6.0					
1.4. ADDITIONAL STANDARDS					
A.	Access Road (Subdivision Regs, S. 7.2)	Minor Complete Street, 50 Ft ROW	Minor Complete Street, 50 Ft ROW	Minor Complete Street, 50 Ft ROW	Minor Complete Street, 50 Ft ROW
B.					
C.					

C. Permitted Building Types in Diversified Residential Developments. The allowed types of residential buildings permitted in different DRDs are identified in Figure 4.4.10 below:

TABLE 4.4.10 - ALLOWED BUILDING TYPES IN DIVERSIFIED RESIDENTIAL DEVELOPMENTS

RESIDENTIAL DEVELOPMENT TYPES	BUILDING TYPES					
	Standard S.F. House	Cottage	Townhouse	Duplex (2 RUs)	Multiplex (3-16 RUs)	Mixed Use Building (MUB)
1. Open Space Residential Development (OSrD)	X	X	X	X	X	
2. Compact Neighborhood Development (CND)						
A. Cottage Court Development (CCD)	X	X	X	X		
B. Traditional Neighborhood Development (TND)	X	X	X	X	X	X
C. Cohousing Development (COD)	X	X	X	X	X	
3. Residential Frontage Development (RFD)	X	X		X		
4. Workforce Housing Infill Lot (WHI)				X		
5. Residential Compound Development (RCD)	X	X	X	X		
6. Adaptive Reuse Residential Development (ARRD)	X	X	X	X	X	X
7. Mixed Use Development/Town Center (MUD-TC)			X		X	X

4.5 ARCHITECTURAL GUIDELINES

The following guidelines outline the general residential building types and architectural design elements that should be viewed as a baseline for well-designed residential architecture in the Town of Winchendon.

- A. Building Massing.** The building massing should be designed to reduce the overall perceived scale and provide simple and evocative forms that reinforce the traditional New England setting and a human-scaled environment of Winchendon.
 1. Strengthen Prominence of Building Entry. Building massing should reinforce the purpose and readability of the building. For example, building massing should emphasize and highlight the location of the primary building entrance.
 2. Visually Reduce Larger Building Scale. Large building masses should be broken down through variations in the roof lines, bays, setbacks, upper-level stepbacks, and other types of architectural articulation. Larger buildings should look like smaller component parts put together.
 3. Simplify Smaller Buildings. Smaller building masses should remain simple and not overly complicated.
 4. Reinforce Consistency with Residential Context. Building massing and scale should be developed to be consistent with the surrounding residential context. Building scale must respect the scale of the residential prototype on which it is based. For example, a connected farmhouse prototype loses its effectiveness and meaning if it becomes too exaggerated or overinflated.

5. Design Variation in Type and Scale. An eclectic variation is a signature of New England communities. Residential development with multiple buildings should vary the building scale and building type. Building types should include enough variability in building massing and scale that repetition is not immediately apparent.

B. Façade Composition and Components. Composition of building facades should include architectural features and building components that reduce the scale of large building masses, reinforce the building character to reflect traditional New England styles, and provide detail and articulation of the overall building.

1. Emphasize Façade Rhythm and Patterns. Building façades should be broken into vertical and horizontal parts that reinforce a rhythm and pattern in the architecture. Building facades, the pattern of windows and doors, and the roof forms should be integrated as a cohesive design. Variation in the façade is encouraged through decorative components, or functional elements such as porches or entryways.
2. Highlight Architectural Detail. Additional architectural detail should be used to reinforce the smaller scale residential character through the use of roof brackets, porches, covered entries, window and door surrounds, or pediment or parapet detail.
3. Conceal Garage Doors. Garage doors should be designed to integrate within the building façade and relate to the aesthetic of carriage doors or barn doors more frequently associated with New England character.
4. Integrate Utilitarian Components into the Façade Design. All functional, utilitarian, or mechanical components of the building facade should be integrated into the façade or screened so as to be part of the composition of the overall building design. Mechanical vents, service elements, and similar components of buildings should be hidden to match other materials and colors of the façade.

C. Historic Structures. When such structures exist and are to be retained, a residential development should integrate and leverage the value of a historic structure within the design and layout of the development plan. Reuse of existing historic structures should follow the U.S. Secretary of the Interior’s Standards for Rehabilitation as appropriate.

1. Integrate Historic Structures. Existing historic structures should be integrated into any new development plan. New buildings and additions should complement and reflect the structure and style of any existing older structures. Historic structures should be considered for adaptive reuse, preservation, sensitive rehabilitation, or restoration as may be appropriate to the historic structure and nature of its reuse.
2. Emphasize Compatible Development. The reuse of the existing historic structure should be compatible with the ability of the structure to accommodate residential uses. New

construction or additions should also be compatible with and complementary to the architectural style of the historic structure.

3. Pursue Thoughtful Renovation. When a historic structure is being renovated to residential use, that renovation should retain the integrity of the historic structure and be sensitive to its underlying design characteristics or historic significance.
4. Create Authenticity to Current Time. New construction or additions should be authentic to the current time in which they are built.

D. Building Roof Forms. Roof form has a significant impact on the character and style of the architecture. Residential roof forms should be both authentic to the type of building they are part of and strive to reinforce a sense of New England neighborhood character and scale.

1. Reinforce New England Village Character. Traditional steeply-pitched roof forms are encouraged in order to reinforce a New England sense of community and assist in managing snow loads. Roof slopes should be in the range of 8:12 to 12:12 (vertical: horizontal). Traditional and most appropriate roof styles in residential developments in New England include gable, hip, mansard, gambrel, saltbox, and shed.
2. Develop Roof Variation. Variation in roof pitch and heights contribute to residential character. Variation in roof types could be used across a different buildings in a residential development but should not be used in combination on a single building.
3. Reinforce a Human-scale to Buildings. Large uninterrupted roof forms should be avoided and articulated with roof gables, dormers, brick or stone chimneys or other roof forms that provide variety and interest to the overall building form.
4. Integrate and Screen Utilities. Mechanical equipment on rooftops should be screened from visibility of pedestrians standing at grade on surrounding walkways by means of walls, decorative grilles, or roof parapets. Screening features should be a part of the building composition and design. Selected materials should complement the overall roof and façade design. Other utilities, such as solar panels should be integrated into the design of the roof.

E. Building Lighting. Building lighting should be used to highlight and emphasize functional and decorative aspects of the building massing and facades. Building lighting should be energy efficient and designed to be minimized and focused on key components of the building. Lighting design must comply with the lighting requirements in Section (XX - Performance Parameters) of the Zoning Bylaw.

1. Define Hierarchy of Lighting. Building entries should be a primary focus of building lighting to reinforce safety, security, and convenience for access to the building. Lighting

to highlight building features, key architectural elements, accents, or signage should be a secondary focus of building lighting.

2. Minimize Quantity of Lighting. Illumination levels should be provided at the minimum level that is required to provide the function desired.
3. Coordinate Light Fixture Design. Lighting fixtures should be selected to contribute to the overall character of the building and development site, and consistent with the overall design and sense of place.



4.6. RESIDENTIAL AND MIXED USE BUILDING TYPES

The following guidelines outline the general residential building types and design elements that should be viewed as a baseline for well-designed and traditional residential forms, patterns, and architecture in a human-scaled environment in the Town of Winchendon. The table also includes design guidelines for accessory dwelling units and community buildings that are often included in diversified residential developments such as open space developments, cottage courts, traditional neighborhood developments, housing cooperatives, and other forms of compact neighborhoods.

FIGURE 4.6.1 - STANDARD SINGLE FAMILY HOUSE DESIGN GUIDELINES	
Definition	Diagram
<p>A moderate floor plate, detached, principal residential building type with one (1) residential unit and ground floor entry typically from a front door.</p>	
Character Examples (For illustrative purpose only)	
	
Typical Specifications*	
Lot Dimensions	
Lot Area	
Rear or No Driveway Access	4,000 - 10,000 SF
Front Driveway Access	5,000 - 15,000 SF
Lot Width	
Rear or No Driveway Access	40 - 70 Ft
Front Driveway Access	55 - 75 Ft
Lot Depth	80 - 150 Ft
Lot Development	
Lot/Area Coverage by Impervious Surface (Max.)	60%
Lot/Area Outdoor Amenity Space (Min.)	20%
Building Placement	
Primary Street Front Setback	10 - 20 Ft.
Secondary Street Front Setback	10 - 20 Ft.
Side Setback	10 Ft.
Rear Setback/Garage from Rear Alley/Access St.	3 Ft.
Rear Setback/Primary Building	30 - 60 Ft.
Building Separation (Min.)	15 Ft.

Building Size and Massing	
Residential Units Per Building Type (Max.)	1 Res. Unit; 2 Accessory Units
Building Footprint	3,000 S.F.
Typical Res. Unit Gross Floor Area (GFA)	< 6,000 S.F. Per Unit
Typical Res. Unit Living Area (L.A.)	2,000 – 3,500 SF
Front Façade Width	22 – 32 Ft.
Front Façade Build Out (% of Building to Lot Width)	50%
Front Façade Off-Set	Not Applicable
Building Depth	28 – 48 Ft.
Ground Floor Elevation (Above Ground Plain)	2 - 4 Ft.
Ground Floor Story Height	9 - 12 Ft.
Upper Story Height (Min./Max.)	9 - 12 Ft.
Building Height/Number of Stories	35 Ft./2.5 Stories
Street Facing Entrance	Preferred
Roof Type	Gable, Hip, Gambrel
Building Outdoor Amenity Space	1/Res. Unit and ADUs
Façade Composition (Street or front facing building elevation)	
Fenestration Ground Floor (Min.)	15 - 50%
Fenestration Upper Floor (Min.)	15 - 50%
Blank Wall (% of front façade without fenestration)	Not Applicable
Parking	
Primary Street Front Setback (Min.)	Behind Front Façade
Side and Rear Setback (Min.)	5 Ft.
Parking Ratio	1 - 2 Spaces Per Residential Unit
Typical Residential Density	
Gross Density	4 - 8 Res. Units/Acre
Additional Design and Development Guidelines	
None	

* Not all residential buildings will be located on a separate lot such as in condominium developments. Where separate lots do not exist, the side and rear setbacks should be doubled to determine appropriate space between primary buildings.

FIGURE 4.6.2 - COTTAGE COURT AND WORKFORCE COTTAGE DESIGN GUIDELINES

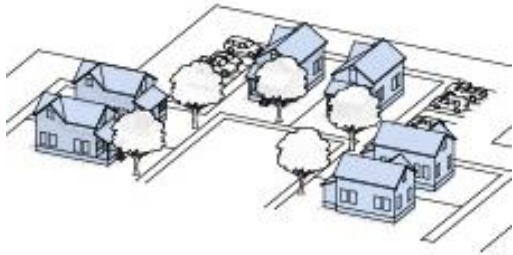
Definition	Diagram
<p>The smallest principal residential building type with one (1) dwelling unit. The cottage typically has a small floor plate, narrow massing, detached or semi-detached, and 1 to 1 1/2 stories. Cottages may be permitted on individual lots or as part of a Cottage Court which is a group of detached or semi-detached cottages arranged and oriented around a shared open space. The common courtyard is an important community-enhancing element that often replaces the backyard and provides direct entrances from the homes. The workforce cottage is a small single family home on a small lot and affordable under Section XXX of the Zoning Bylaw.</p>	

Character Examples (For illustrative purpose only)

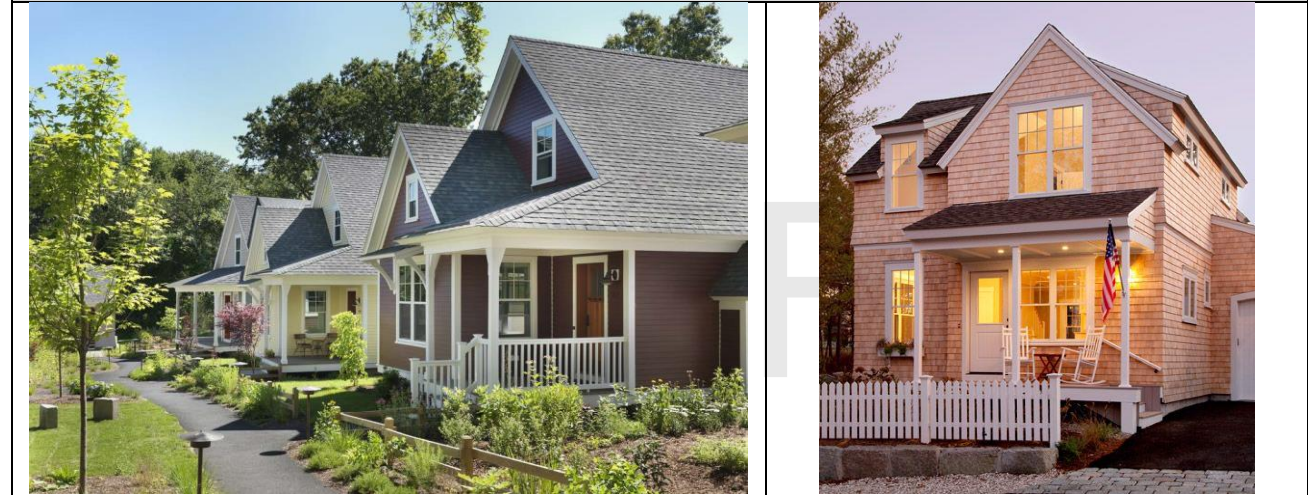

Typical Lot and Building Specifications*

Cottage Court Tract Size**	
Width	115 - 160 Ft.
Depth	100 - 150 Ft.
Area	11,500 - 24,000 S.F.
Number of Cottages Per Common Court	5 - 16 Res. Units
Lot Dimensions	
Lot Area	
Rear or No Driveway Access	4,000 - 10,000 SF
Front Driveway Access	5,000 - 15,000 SF
Lot Width	
Rear or No Driveway Access	32 - 48 Ft
Front Driveway Access	34 - 48 Ft
Lot Depth	70 - 100 Ft.
Lot Development	
Lot/Area Coverage by Impervious Surface (Max.)	60%

Lot/Area Outdoor Amenity Space (Min.)	20%
Building Placement	
Primary Street Front Setback	10 - 20 Ft.
Secondary Street Front Setback	10 - 20 Ft.
Side Setback	5 - 10 Ft.
Rear Setback/Garage from Rear Alley/Access St.	3 Ft.
Rear Setback/Primary Building	20 - 30 Ft.
Building Separation (Min.)	10 Ft.
Building Size and Massing	
Residential Units Per Building Type (Max.)	1 Res. Unit
Building Footprint	1,800 S.F.
Typical Res. Unit Gross Floor Area (GFA)	< 3,000 S.F. Per Unit
Typical Res. Unit Living Area (L.A.)	500 – 1,800 SF
Front Façade Width	18 – 24 Ft.
Front Façade Build Out (% of Building to Lot Width)	60%
Front Façade Off-Set	Not Applicable
Building Depth	24 – 36 Ft.
Ground Floor Elevation (Above Ground Plain)	2 - 3 Ft.
Ground Floor Story Height	8 - 10 Ft.
Upper Story Height (Min./Max.)	8 - 10 Ft.
Building Height/Number of Stories	24 Ft./1.5 Stories
Street Facing Entrance	Preferred
Roof Type	Gable, Hip, Gambrel
Building Outdoor Amenity Space	1/Res. Unit
Façade Composition (Street or front facing building elevation)	
Fenestration Ground Floor (Min.)	15 - 50%
Fenestration Upper Floor (Min.)	15 - 50%
Blank Wall (% of front façade without fenestration)	Not Applicable
Parking	
Primary Street Front Setback (Min.)	Behind Front Façade
Side and Rear Setback (Min.)	5 Ft.
Parking Ratio	1 - 2 Spaces Per Residential Unit
Typical Residential Density	
Gross Density	10 - 20 Res. Units Per Acre
Additional Design and Development Guidelines	
None	

* Not all residential buildings will be located on a separate lot such as in condominium developments. Where separate lots do not exist, the side and rear setbacks should be doubled to determine appropriate space between primary buildings.

** A Cottage Court Development may contain more than one Courts with 5 to 16 Cottages



FIGURE 4.6.3 - DUPLEX DESIGN GUIDELINES

Definition	Diagram
<p>A detached residential building that consists of two (2) residential units each with an entry from the street. This building type has the appearance of a small-to-medium single family house and may include a rear yard and rear access from an alley.</p>	
Character Examples (For illustrative purpose only)	
	
Typical Specifications*	
Lot Dimensions	
Lot Area	
Rear or No Driveway Access	4,000 - 10,000 S.F.
Front Driveway Access	5,000 - 15,500 S.F.
Lot Width	
Rear or No Driveway Access	40 - 70 Ft
Front Driveway Access	55 - 75 Ft
Lot Depth	100 - 150 Ft
Lot Development	
Lot/Area Coverage by Impervious Surface (Max.)	60%
Lot/Area Outdoor Amenity Space (Min.)	20%
Building Placement	
Primary Street Front Setback	10 - 20 Ft.
Secondary Street Front Setback	10 - 20 Ft.
Side Setback	10 Ft.
Rear Setback/Garage from Rear Alley/Access St.	3 Ft.
Rear Setback/Primary Building	30 - 60 Ft.
Building Separation (Min.)	20 Ft.
Building Size and Massing	
Residential Units Per Building Type (Max.)	2 Res. Units

Building Footprint	1,500 S.F. Per Res. Unit
Typical Res. Unit Gross Floor Area (GFA)	< 3,000 S.F. Per Unit
Typical Res. Unit Living Area (L.A.)	600 – 2,400 SF
Front Façade Width	28 – 55 Ft.
Front Façade Build Out (% of Building to Lot Width)	50%
Front Façade Off-Set	Not Applicable
Building Depth	28 – 60 Ft.
Ground Floor Elevation (Above Ground Plain)	2 - 4 Ft.
Ground Floor Story Height	9 - 12 Ft.
Upper Story Height (Min./Max.)	9 - 12 Ft.
Building Height/Number of Stories	35 Ft./2.5 Stories
Street Facing Entrance	Preferred
Roof Type	Gable, Hip, Gambrel
Building Outdoor Amenity Space	1/Res. Unit
Façade Composition (Street or front facing building elevation)	
Fenestration Ground Floor (Min.)	15 - 50%
Fenestration Upper Floor (Min.)	15 - 50%
Blank Wall (% of front façade without fenestration)	Not Applicable
Parking	
Primary Street Front Setback (Min.)	Behind Front Façade
Side and Rear Setback (Min.)	5 Ft.
Parking Ratio	1 - 2 Spaces Per Residential Unit
Typical Residential Density	
Gross Density	6 - 12 Res. Units/Acre
Additional Design and Development Guidelines	
The two (2) residential units within a duplex building type may be side-by-side and both oriented toward the front lot line. On corner lots, one residential unit may be oriented toward each front lot line resulting in units that are back-to-side in orientation. Dwelling units that are stacked one over the other or attached front to back in orientation are also permitted.	

* Not all residential buildings will be located on a separate lot such as in condominium developments. Where separate lots do not exist, the side and rear setbacks should be doubled to determine appropriate space between primary buildings.

FIGURE 4.6.4 - TRIPLEX BUILDING DESIGN GUIDELINES

Definition	Diagram
<p>A small-to-medium sized detached structure that consists of three (3) residential units that are stacked on top of each other on consecutive floors, attached side by side, or a combination of both. There is typically one entry for each ground floor unit and a shared entry for the units above. Side-by-side Triplexes may be designed to resemble large farmhouses with attached carriage houses. A triplex may be located on one (1) or more lots and each of the dwelling unit is intended to be occupied by one (1) family.</p>	
Character Examples (For illustrative purpose only)	
	
Typical Specifications*	
Lot Dimensions	
Lot Area	
Rear or No Driveway Access	5,000 - 11,000 S.F.
Front Driveway Access	6,500 - 15,500 S.F.
Lot Width	
Rear or No Driveway Access	40 - 55 Ft.
Front Driveway Access	40 - 65 Ft.
Lot Depth	85 - 150 Ft.
Lot Development	
Lot/Area Coverage by Impervious Surface (Max.)	65%
Lot/Area Outdoor Amenity Space (Min.)	20%
Building Placement	
Primary Street Front Setback	10 - 25 Ft.
Secondary Street Front Setback	10 - 25 Ft.
Side Setback	8 - 12 Ft.
Rear Setback/Garage from Rear Alley/Access St.	3 Ft.
Rear Setback/Primary Building	30 - 60 Ft.
Building Separation (Min.)	15 - 25 Ft.
Building Size and Massing	
Residential Units Per Building Type (Max.)	3 Res. Units
Building Footprint (Max.)	1,800 S.F. Per Res. Unit
Typical Res. Unit Gross Floor Area (GFA)	< 2,000 S.F. Per Res. Unit

Typical Res. Unit Living Area (L.A.)	700 - 1,600 S.F.
Front Façade Width	36 – 55 Ft.
Front Façade Build Out (% of Building to Lot Width)	70%
Front Façade Off-Set	Not Applicable
Building Depth	35 – 64 Ft.
Ground Floor Elevation (Above Ground Plain)	2 - 4 Ft.
Ground Floor Story Height	9 - 12 Ft.
Upper Story Height (Min./Max.)	9 - 12 Ft.
Building Height/Number of Stories	35 Ft./2.5 Stories
Street Facing Entrance	Preferred
Roof Type	Gable, Hip, Gambrel
Building Outdoor Amenity Space	1/Res. Unit
Façade Composition (Street or front facing building elevation)	
Fenestration Ground Floor (Min.)	15 - 50%
Fenestration Upper Floor (Min.)	15 - 50%
Blank Wall (% of front façade without fenestration)	Not Applicable
Parking	
Primary Street Front Setback (Min.)	Behind Front Façade
Side and Rear Setback (Min.)	5 Ft.
Parking Ratio	1 - 2 Spaces Per Residential Unit
Typical Residential Density	
Gross Density	8 - 20 Res. Units/Acre
Additional Design and Development Guidelines	
None	

* Not all residential buildings will be located on a separate lot such as in condominium developments. Where separate lots do not exist, the side and rear setbacks should be doubled to determine appropriate space between primary buildings.

FIGURE 4.6.5 - MULTIPLEX BUILDING DESIGN GUIDELINES

Definition	Diagram
<p>A moderate floor plate, detached, multi-story principal residential building type with four (4) to sixteen (16) residential units primarily accessed from a single principal entrance and interior hallway or stairway. A multiplex may include apartments, condominiums, or cooperative residential units, and shared spaces within the building for utilities and amenities.</p>	
Character Examples (For illustrative purpose only)	
	
Typical Specifications*	
Lot Dimensions	
Lot Area	
Rear or No Driveway Access	7,500 - 15,500 S.F.
Front Driveway Access	9,600 - 18,000 S.F.
Lot Width	
Rear or No Driveway Access	100 - 150 Ft.
Front Driveway Access	96 - 120 Ft.
Lot Depth	100 - 150 Ft.
Lot Development	
Lot/Area Coverage by Impervious Surface (Max.)	65%
Lot/Area Outdoor Amenity Space (Min.)	20%
Building Placement	
Primary Street Front Setback	10 - 25 Ft.
Secondary Street Front Setback	10 - 25 Ft.
Side Setback	8 - 12 Ft.
Rear Setback/Garage from Rear Alley/Access St.	3 Ft.
Rear Setback/Primary Building	30 - 60 Ft.
Building Separation (Min.)	15 - 25 Ft.
Building Size and Massing	
Residential Units Per Building Type (Max.)	4 - 16 Res. Units
Building Footprint (Max.)	1,000 S.F. Per Res. Unit

Typical Res. Unit Gross Floor Area (GFA)	< 2,000 S.F. Per Res. Unit
Typical Res. Unit Living Area (L.A.)	400 - 1,200 S.F.
Front Façade Width	50 – 100 Ft.
Front Façade Build Out (% of Building to Lot Width)	70%
Front Façade Off-Set (Articulation Per Linear Foot)	4 Feet Per Each 50 Linear Feet
Building Depth	35 – 75 Ft.
Ground Floor Elevation (Above Ground Plain)	2 - 4 Ft.
Ground Floor Story Height	9 - 12 Ft.
Upper Story Height (Min./Max.)	9 - 12 Ft.
Building Height/Number of Stories	40 Ft./2.5 Stories
Street Facing Entrance	Preferred
Roof Type	Gable, Hip, Gambrel, Flat
Building Outdoor Amenity Space	1/Res. Unit
Façade Composition (Street or front facing building elevation)	
Fenestration Ground Floor (Min.)	15 - 50%
Fenestration Upper Floor (Min.)	15 - 50%
Blank Wall (% of front façade without fenestration)	Not Applicable
Parking	
Primary Street Front Setback (Min.)	Behind Front Façade
Side and Rear Setback (Min.)	5 Ft.
Parking Ratio	1 - 2 Spaces Per Residential Unit
Typical Residential Density	
Gross Density	12 - 20 Res. Units/Acre
Additional Design and Development Guidelines	
None	

* Not all residential buildings will be located on a separate lot such as in condominium developments. Where separate lots do not exist, the side and rear setbacks should be doubled to determine appropriate space between primary buildings.



FIGURE 4.6.6 – TOWNHOUSE/ROWHOUSE DESIGN GUIDELINES

Definition	Diagram
<p>A small-to medium-sized attached structure that consists of 3 or more multi-story single family residential units placed side-by-side and attached by a common wall. Entries are typically on the narrow side of the unit and facing a street or courtyard. Vehicle access and parking garages are located to the side or rear of the residential units.</p>	
Character Examples (For illustrative purpose only)	
	
Typical Specifications*	
Lot Dimensions	
Lot Area	
Rear or No Driveway Access	1,600 - 5,000 S.F.
Front Driveway Access	1,600 - 5,000 S.F.
Lot Width	
Rear or No Driveway Access	25 - 32 Ft.
Front Driveway Access	18 - 25 Ft.
Lot Depth	85 - 120 Ft.
Lot Development	
Lot/Area Coverage by Impervious Surface (Max.)	65%
Lot/Area Outdoor Amenity Space (Min.)	20%
Building Placement	
Primary Street Front Setback	10 - 25 Ft.
Secondary Street Front Setback	10 - 25 Ft.
Side Setback (Where no common wall exists)	8 - 12 Ft.
Rear Setback/Garage from Rear Alley/Access St.	3 Ft.
Rear Setback/Primary Building	20 - 60 Ft.
Building Separation (Min.)	20 Ft.
Building Size and Massing	
Residential Units Per Building Type (Max.)	3 - 8 Res. Units Per Group

Building Footprint (Max.)	1,400 S.F. Per Res.Unit
Typical Res. Unit Gross Floor Area (GFA)	<3,000 S.F. Per Res. Unit
Typical Res. Unit Living Area (L.A.)	1,000 - 2,700 S.F.
Front Façade Width	18 – 30 Ft.
Front Façade Build Out (% of Building to Lot Width)	70%
Front Façade Off-Set (Articulation Per Linear Foot)	Not Applicable
Building Depth	34 – 60 Ft.
Ground Floor Elevation (Above Ground Plain)	2 - 4 Ft.
Ground Floor Story Height	9 - 12 Ft.
Upper Story Height (Min./Max.)	9 - 12 Ft.
Building Height/Number of Stories	35 Ft./2.5 Stories
Street Facing Entrance	Yes
Roof Type	Gable, Mansard, Flat
Building Outdoor Amenity Space	1/Res. Unit
Façade Composition (Street or front facing building elevation)	
Fenestration Ground Floor (Min.)	15 - 50%
Fenestration Upper Floor (Min.)	15 - 50%
Blank Wall (% of front façade without fenestration)	Not Applicable
Parking	
Primary Street Front Setback (Min.)	Behind Front Façade
Side and Rear Setback (Min.)	5 Ft.
Parking Ratio	1 - 2 Spaces Per Residential Unit
Typical Residential Density	
Gross Density	12 - 20 Res. Units/Acre
Additional Design and Development Guidelines	
1. Townhouses typically have stoops on the front façade and a private dooryard/garden or a shared common between the building and street line.	
2. No more than 8 residential units may be attached without a space of at least 20 feet between another group of attached residential units.	
3. The front facades of individual units can be staggered as much as 4 feet with recessed or projecting bays along the street line.	

* Not all residential buildings will be located on a separate lot such as in condominium developments. Where separate lots do not exist, the side and rear setbacks should be doubled to determine appropriate space between primary buildings.

FIGURE 4.6.7 - MIXED USE BUILDING DESIGN GUIDELINES

Definition	Diagram
<p>A moderate floor plate, multi-story principal building type with ground story commercial uses and the occupancy of upper stories for permitted uses including residential units at a scale that is compatible and complimentary to its given district.</p>	
Character Examples (For illustrative purpose only)	
	
Typical Specifications*	
Lot Dimensions	
Lot Area	
Rear or No Driveway Access	Not Required
Front Driveway Access	Not Required
Lot Width (Min.)	
Rear or No Driveway Access	30 Ft.
Front Driveway Access	50 Ft.
Lot Depth (Min.)	60 Ft.
Lot Development	
Lot/Area Coverage by Impervious Surface (Max.)	80%
Lot/Area Outdoor Amenity Space (Min.)	15%
Building Placement	
Primary Street Front Setback	2 - 12 Ft.
Secondary Street Front Setback	2 - 12 Ft.
Side Setback (Where no common wall exists)	8 - 12 Ft.
Rear Setback/Alley, Access St. or ROW	2 Ft.
Rear Setback/Residential District	50 Ft.
Building Separation (Min.)	Not Required
Building Size and Massing	
Residential Units Per Building Type (Max.)	1 - 16 Res. Units
Building Footprint (Max.)	Not Applicable







Typical Res. Unit Gross Floor Area (GFA)	<2,700 S.F. Per Res. Unit
Typical Res. Unit Living Area (L.A.)	400 - 1,500 S.F.
Front Façade Width	30 - 150 Ft.
Front Façade Build Out (% of Building to Lot Width)	80% Primary Frontage; 65% Secondary Frontage
Front Façade Off-Set (Articulation Per Linear Foot)	4 Ft Recess/Projection Per 50 Linear Ft. Feet
Building Depth	60 – 100 Ft.
Ground Floor Elevation (Above Ground Plain)	0 Ft. or Full ADA accessibility
Ground Floor Story Height (Min.)	12 Ft.
Upper Story Height (Min.)	10 Ft.
Building Height/Number of Stories	30 Ft./2 Stories
Street Facing Entrance	Yes
Roof Type	Gable, Hip, Flat
Building Outdoor Amenity Space	1/Res. Unit
Façade Composition (Street or front facing building elevation)	
Fenestration Ground Floor (Min.)	70%
Fenestration Upper Floor (Min.)	15 - 50%
Blank Wall (% of front façade without fenestration)	20 Linear Feet maximum
Parking	
Primary Street Front Setback (Min.)	Behind Front Façade
Side and Rear Setback (Min.)	3 Ft.
Parking Ratio	1 - 2 Spaces Per Residential Unit
Typical Residential Density	
Gross Density	12 - 20 Res. Units/Acre
Additional Design and Development Guidelines	
1. Parking can be integrated within the building footprint either at grade or below grade; Tandem parking can be provided for individual residential units.	
2. See Design Guidelines for Town Center and Outdoor Amenity Spaces in the Planning Board Zoning Regulations	

* Not all residential buildings will be located on a separate lot such as in condominium developments. Where separate lots do not exist, the side and rear setbacks should be doubled to determine appropriate space between primary buildings.

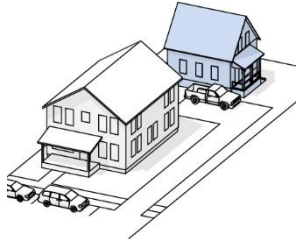
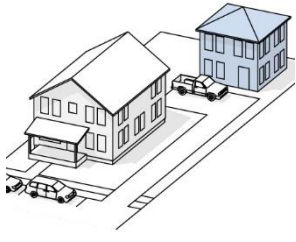
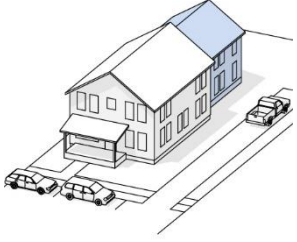
4.7. ACCESSORY DWELLING UNITS AND COMMUNITY BUILDING TYPES



A. Accessory Dwelling Units (ADU). ADU types and design guidelines are defined in Figure 4.7.1 below.

FIGURE 4.7.1 - DESIGN GUIDELINES FOR ACCESSORY DWELLING UNITS AND HOME-BASED BUSINESSES

1. ACCESSORY DWELLING BUILDING TYPES AND DEFINITION				
	Backyard Cottage (GC)	Carriage House Unit (CHU)	Integrated Units (IU)	Penthouse Unit (PU)
1.1 BUILDING DIAGRAM				
1.3 CHARACTER EXAMPLES				
1.2 DEFINITION	A detached accessory residential building with one (1) residential unit intended for a single family.	A detached or semi-attached accessory residential building that includes a residential unit combined with a garage or home business. Carriage House Units have separate entrances and are located to the rear of the main house.	An attached accessory residential unit located within the side or rear of the main house or within the existing footprint of the main house and with a separate entrance.	An accessory dwelling units on the rooftop of a commercial building in a commercial district.

2. ACCESSORY DWELLING/BUILDING DESIGN GUIDELINES					
		Backyard Cottage (GC)	Carriage House Unit (CHU)	Integrated Units (IU)	Penthouse Unit (PU)
2.1	Building Width	12 Ft Min./20 Ft Max..	30 Feet Max.	90% of Main House	60% of Main Building
2.2	Building Depth	30 Feet Max.	60 Feet Max.	50% of Main House	80% of Main Building
2.3	Total Stories	1.5 Max.	2.5 Max.	2.5 Max.	1 Max.
2.4	Total Height	20 Feet Max.	30 Feet Max.	30 Feet Max.	12 Feet Max.
2.5	Res. Unit Living Area (L.A.)	900 S.F. Min.	900 S.F. Min.	900 S.F. Min.	900 S.F. Min.
2.6	Total Area (GFA)	1,400 Gross Floor Area	75% of Main House	40% of Main House	40% of Main Building
2.7	Building Footprint (Max)	NR	75% of Main House	40% of Main House	40% of Main Building
2.8	Roof Type	All	All	All	Flat, Shed
2.9	Ground Story Fenestration	20% Min.	20% Min.	20% Min.	20% Min.

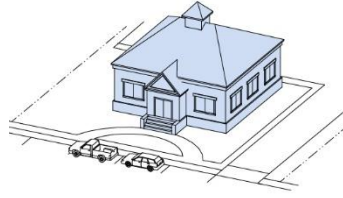
B. Residential Development Community Buildings. See Figure 4.7.2 Below.

TABLE 4.7.2 - DESIGN GUIDELINES FOR RESIDENTIAL COMMUNITY BUILDINGS		
1 ACCESSORY BUILDING TYPES AND DEFINITION		
	Community Building (CB)	
1.1 BUILDING DIAGRAM AND CHARACTER EXAMPLE		
1.2 DEFINITION	A detached accessory building located and designed for common use and enjoyment such as for social, educational, recreational, and similar community activities.	
2. BUILDING DESIGN GUIDELINES		
	Community Building (CB)	
2.1	Building Width	NR
2.2	Building Depth	NR
2.3	Total Stories	1.5 Max.
2.4	Total Height	30 Feet Max.
2.5	Res. Unit Living Area (L.A.)	NR
2.6	Total Area (GFA)	100% of the Largest Res. Unit in the Development
2.7	Building Footprint (Max)	100% of the Largest Res. Unit in the Development
2.8	Roof Type	All
2.9	Ground Story Fenestration	20% Min.

C. Home Based Accessory Business Units. Accessory home based businesses and accessory structures should flow the design standards for accessory dwelling units in Figure 4.7.1 above.

4.8. SIGNAGE STANDARDS

Signage for residential developments should be functional and attractive. Site signage must comply with the Sign Regulations in **Article 9 of the Zoning Bylaw**. These guidelines focus on well-designed signage in the context of compliance with applicable regulations.

A. General Guidelines. Signage for residential developments should identify the community, promote a positive image, and harmonize with its surroundings.

1. Reinforce New England Character. Sign design should be appropriate to Winchendon’s traditional New England character. Historic characteristics should be used such as

muted colors, traditional font styles and sign faces, materials such as wood or wood composite, and lettering that is painted, carved dimensionally, vinyl cut, sand-blasted, etched, or metal channel-cut.

2. Emphasize Legibility and Clarity. A sign should be readable, simple, and legible, with careful consideration of the proportion of lettered and graphic areas to the overall size and location of the sign, and consideration of the purpose and intended audience of the sign. Lettering should be concise and graphically balanced. Generally, a sign's text and graphic elements should not occupy more than two-thirds of the sign panel area.
3. Focus Signage Content. Signage messaging should be simple and brief. Signage should communicate only the name of the residential community and/or wayfinding within the community. Signage may also include home occupation businesses that should be respectful of the residential context.
4. Use Signage Color. Signage color should complement building materials and color palette.
5. Coordinate Signage Materials. Signage materials should be selected for durability, ease of maintenance, and compatibility with building materials and design.

B. Sign Harmony.

1. Reinforce Compatibility with Context. Signs should be designed to be compatible with neighboring properties through sign style, height, type, scale and location. Illumination should be designed to minimize impact on adjacent residences.
2. Coordination with Building Architecture. Sign design and placement should relate to and harmonize with the building architecture. Signs should not overwhelm or obscure building features.

C. Site Signage.

1. Integrate Signage Design with Landscape. Site signage should be integrated with site landscape design and be used to reinforce gateway locations and site entry points. Landscape plantings should be included to anchor and integrate signage into the site plan.
2. Simplify Development Signage. Signage should indicate the overall residential development and community name or branding features. This type of signage should be balanced and in scale with both the overall scale of the development and the surrounding context. Signage for individual single-family and two-family homes is discouraged unless they are part of an agricultural business.
3. Minimize Wayfinding Signage. Simple directional signage may be provided on the site to inform visitors of entries, parking areas, or other information. Wayfinding signage

should be consistent and compatible with other development signage. Wayfinding signage should not obstruct or cause conflict with regulatory or traffic-related signage.

D. Sign Illumination. External signage illumination is encouraged and should be targeted only onto the sign, not onto adjacent buildings or towards vehicles or pedestrians.

1. Minimize Signage Lighting Fixtures. External lighting fixtures that project the light from above or below the sign are strongly encouraged. Light fixtures should be simple and unobtrusive and should not obscure the sign’s message and graphics. Raceways, conduits, and other electrical components should be concealed from public view.
2. Provide Consistent Lighting Levels. Lighting should provide a consistent and even wash of light across the sign.



6.0 SIGNS

6.1. INTENT

The intent of these sign design standards is to provide property owners and business occupants an opportunity for effective identification subject to reasonable, yet appropriate conditions for identifying goods sold or produced or services rendered in the designated zoning districts, and maintain and enhance the quality of Winchendon's appearance by:

- A. Controlling the size, location and design of temporary and permanent signs so that the appearance of such signs will reduce sign clutter, be aesthetically harmonious with their surroundings, and will enhance the overall appearance of the built environment.
- B. Ensuring that signs are located and designed to maintain a safe and orderly pedestrian and vehicular environment; and reduce potentially hazardous conflicts between commercial or identification signs and traffic control devices and signs.
- C. Providing a pleasing overall appearance, historic setting, and community character which is vital to economic attractiveness of the Downtown Winchendon area;
- D. Allowing signs appropriate to the planned character of the zoning districts within the context of commercial corridors, industrial areas and business parks, and neighborhoods of different scale and intensity; and
- E. Promoting the public safety, welfare, convenience and enjoyment of the residents of Winchendon.

6.2. APPLICABILITY

- A. The provisions of this section will **compliment** the Winchendon Zoning Bylaw, Article 9.
- B. Nothing contained in this section shall be construed as the content-based regulation of sign messages prohibited by the federal or state constitution, statutes, or court decisions.
- C. Nothing contained in this section shall be construed to conflict with M.G.L. Chapter 85, Section 8 & 9 or M.G.L. Chapter 93, Sections 29 through 33, as amended.

6.3. SPECIAL PERMIT REVIEW

- A. Review Criteria.** Signs permitted by Special Permit require supplemental review and must meet certain performance standards for the issuance of a sign permit. The Planning Board shall serve as the Special Permit Granting Authority (SPGA) for the purpose of reviewing Special Permit applications for signs under this section. In its discretion to approve or deny a special permit to authorize a sign, the SPGA shall consider the following criteria:

1. Design of the sign as an effective means of communication.
2. Compatibility with the visual character of the surrounding area.
3. Appropriate sizing for the location.
4. The potential for adverse effects on nearby properties and pedestrian and traffic safety.

B. Concurrent Applications. Review of Special Permit applications that appear before the Planning Board for projects additionally requiring site plan review may appear concurrently before the board in accordance with the submission and procedure requirements for such applications.

6.4. SIGN MAINTENANCE, ABANDONMENT AND REMOVAL

- A. All signs, including nonconforming signs, together with any supports, braces, anchors, and other supporting hardware, must be maintained in good condition or state of equivalent quality to which was approved or required by the Town. If the Zoning Enforcement Officer is of the opinion that a sign is not secure, safe or in good state of repair, it shall give written notice of this fact to the person responsible for the maintenance of the sign. If the defect in the sign is not corrected within the time permitted, the Zoning Enforcement Officer may revoke the permit to maintain the sign and may remove the sign and keep possession of same until the owner pays the cost of removal.
- B. When an existing sign is removed, replaced, or repaired, all supports, braces, anchors, and other supporting hardware that is no longer required must be removed, and any surfaces baring evidence of attachment must be repaired.
- C. An on-premises sign advertising an activity, business, service or product must be removed or the sign face replaced with a blank face within 60 days of the activity, business, or service promoted by the sign being discontinued on the premises where the Sign is displayed.
- D. If the use is not reestablished or a new use is not established within two (2) years, then the entire sign structure and mounting hardware must be removed.

6.5. MAXIMUM BUILDING SIGNAGE AND SIGN COPY AREA

- A. The maximum square footage of all signage for a building in the specified zoning district shall be the combined length of all building primary street frontage multiplied by two. This includes any combination of Permanent Principal Signs in accordance with the standards established in Figure 6.9.2 for individual sign types.
- B. For A-frame, awning/canopy, building mounted, freestanding, and projecting signs, the sign copy area shall be considered to include all lettering, wording, and accompanying designs and symbols, together with the background, whether open or enclosed, on which they are

displayed, but not including any supporting framework and bracing that are incidental to the display itself. Only one side of a projecting sign shall be counted in computing the total square feet of signs on a sign frontage.

- C. For a sign painted upon or applied to a building, the area shall be considered to include all lettering, wording, and accompanying designs or symbols, together with any background of a different color than the natural color of the building.
- D. For a sign consisting of individual letters or symbols attached to or painted on a surface, building, canopy, awning, wall or window, the area shall be considered that of the smallest rectangle or other geometric shape that encompasses all of the letters or symbols.

6.6. SIGN ILLUMINATION

Conforming signs may be illuminated according to the following standards:

A. General. Illuminated signs indicating if a business is open must be turned off except during the hours of operation.

B. External Illumination.

1. An externally illuminated sign is characterized by the use of artificial light reflected off the surface of a sign.
2. External light sources must be shielded so that they illuminate only the face of the sign and do not shine directly onto a public right-of-way or onto adjacent properties.
3. Light fixtures that project from the facade of a building for externally illuminated signs are exempt from setback requirements but should be simple and unobtrusive in design and not obscure the sign content.

C. Internal Illumination.

1. An internally illuminated sign is characterized by the use of artificial light projecting through or from behind the surface of a sign.
2. Channel letters may be internally lit or back-lit.
3. Blade signs may be internally lit if the background is opaque or of a darker color than the message of the sign and the lettering is no more than 50% of the surface area of the sign
4. Exposed neon is only permitted for wall or windows signs.

D. Backlit (i.e., Halo) Signs. Backlit Signs shall light lettering and logo and other related sign elements only, and lighting design shall be such that no excess light spill or glare results from the back lighting fixtures and/or source. The back lit sign shall not increase the measurable vertical light level at a point 20 feet distant from the Sign in any direction.

E. Neon Signs. Neon signs are permitted by Special Permit as an alternative form of Band, Blade,

or Window sign subject to the same design standards in Figure 6.9.2.

6.7. STRUCTURES AND INSTALLATION

- A. Support Elements.** Supports and braces shall be designed as an integral part of the sign design and hidden from public view to the maximum extent practical.
- B. Electrical Service.**
1. All electrical fixtures, devices, circuits, conduits, raceways or apparatus used to illuminate, move or project any sign shall be installed and maintained in accordance with the building code and the electrical code. Electrical permits are required for signs with an electrical component.
 2. When electrical service is provided to freestanding signs, all such electrical service is required to be underground and concealed.
 3. Conduits and other components of a sign illumination system shall be designed as an integral part of the sign design and hidden from public view to the maximum extent practical.
- C. Limitation on Attachments and Secondary Uses.** All permitted sign structures and their associated landscape areas shall be kept free of supplemental attachments or secondary uses including, but not limited to, supplemental advertising signs not part of a permitted sign, light fixtures, newspaper racks, or trash containers. The use of sign structures and associated landscape areas as support structures for outdoor product display is prohibited.
- D. Durable Materials.** All permanent signs permitted by this section shall be constructed of durable materials capable of withstanding continuous exposure to the elements and the conditions of an urban environment.

6.8. SIGN PLACEMENT AT INTERSECTIONS

For parcels located at the corner of two intersecting public or private streets including, but not limited to, driveways and service lanes associated with commercial and/or business sites, a clear view triangle shall be maintained. The triangle shall be the area formed by measuring a distance of 20 feet from the corner of the parcel along the lot lines and connecting the end points so as to establish a triangle on the area of the lot adjacent to the street and/or drive intersections. No sign, nor any part of a sign, other than a supporting pole or brace measuring 18 inches or less in width or diameter, shall be located between 3 feet and 10 feet above the grade within this sight triangle.

6.9. PERMITTED ACCESSORY AND PRINCIPAL SIGNS

- A. Permanent Accessory Signs Standards.** Permanent Accessory Signs shall meet the standards

set forth in Tables 7.1 and 7.3.A through E below:

FIGURE 6.9.1 - PERMANENT ACCESSORY SIGNS				
Sign Types	R	C	I	PD
A. A-Frame/Sandwich Board Signs				P
B. Display Case				P
C. Directory Signs and Nameplates				P
D. Other Accessory Signs				SP
P - Permitted by Right with Specifications under this Article				
SP- Permitted by Special Permit from the Planning Board.				

B. Permanent Principal Signs Standards. Permanent Principal Signs shall meet the standards set forth in Tables 7.2 and 7.4.A through K below:

FIGURE 6.9.2 - PERMANENT PRINCIPAL SIGNS				
Sign Types ¹	R	C	I	PD
A. Awning and Canopy Signs				P
B. Bracket Signs				P
C. Blade and Projecting Signs				P
D. Freestanding and Yard Signs				P
E. Vertical Blade/Banner Signs				P
F. Marquee Signs				P
G. Suspended Signs				P
H. Wall Mural				P
I. Window Signs				P
J. Wall Signs				P
K. Other Principal Signs				SP
P - Permitted by Rights with Specifications under this Section				
SP - Permitted by Special Permit by the Planning Board				
1. All signs internally illuminated and/or including a static or dynamic message board shall require a special permit.				

FIGURE 6.9.3 - PERMANENT ACCESSORY SIGN STANDARDS

professional manner free from chipping paint, cracks, loss of letters, and other damages.

A. A-FRAME AND SANDWICH BOARD SIGNS



DEFINITION:

A freestanding portable sign, not secured or attached to the ground or any building or structure, composed of a sign panel and supporting structure or one or more panels which form both the structure and sign face, and which is intended to be placed in a sidewalk or pedestrian way.

ZONING DISTRICTS ALLOWED:

See Figure 6.9.1

SIGN SPECIFICATIONS:

Number of Signs:	1 per business unit max.
Placement:	8 feet from principal entrance max.
Sign Height:	4 feet max.
Sign Width:	2 feet max.
Sign Area:	8 sq. ft. max per side.
Illumination:	Prohibited

OTHER FUNCTIONAL STANDARDS:

One (1) Sidewalk sign is permitted per ground story tenant.

Sidewalk signs may be placed outdoors on site or on a public sidewalk during business hours and must be removed when the business is closed.

Sidewalk signs displayed on a public sidewalk are prohibited from interfering with pedestrian travel and shall leave clear an accessible walkway area of 4 feet minimum.

A sidewalk sign must be vertically oriented, with a height greater than its width and made of wood, metal, or slate (chalkboard).

A sidewalk sign is not permitted to be illuminated or contain any electronic components.

A sidewalk sign may not be placed outdoors when high winds, heavy rain, or heavy snow conditions are present. The Department Public Works may remove a sidewalk sign during snow removal operations, and is not liable for damage to a sidewalk sign caused by snow removal operations.

Design/Construction: Constructed of a min. ¾" high density exterior grade compressed wood or molded plastic of weight and durability to withstand wind gusts and maintained in a

B. DISPLAY CASE

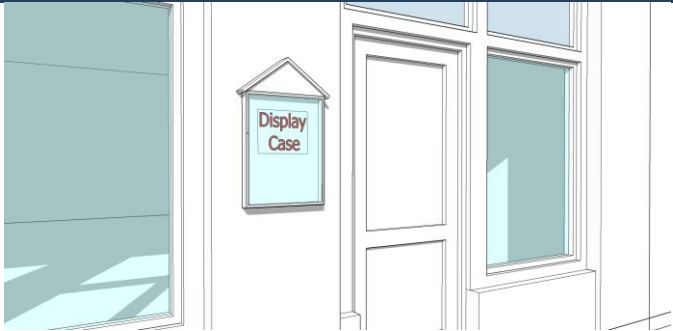

DEFINITION:

A wall mounted, lockable, framed cabinet with a transparent window to display a changeable menu or list of event show times. Display cases are intended to be viewed at close range by pedestrians.

ZONING DISTRICTS ALLOWED:

See Table Figure 6.9.1

SIGN SPECIFICATIONS:

Number of Signs:	1 per 4 business; 4 max. for theaters per frontage.
Placement:	Shall be attached to the building wall on the primary or secondary frontage.
Sign Height:	Top of sign case shall not exceed 7 feet from grade.
Sign Width:	4 feet max.
Sign Area:	6 feet max.
Illumination:	Non-illuminated, or illuminated from inside the display case.

OTHER FUNCTIONAL STANDARDS:

Outdoor display cases for theaters may be larger but shall not exceed 12 sq. ft.

C. DIRECTIONAL SIGNS



DEFINITION:

A traffic, direction or informational on-premises sign located on private property at the curb cuts of an establishment giving direction or information as to entrance, exit and/or the like. Such signs may contain a logo or other information identifying the use of the premises so long as such information is for direction and point of reference and not for advertising purposes. Directional Signs may include information and directions necessary or convenient for persons accessing the property including signs marking entrances and exits, parking areas, one-way drives, rest rooms, pickup and delivery areas, loading zones and the like.

ZONING DISTRICTS ALLOWED:

See Figure 6.9.1

SIGN SPECIFICATIONS:

Number of Signs:	Unlimited, except that directional signs placed near driveway openings shall be limited to a max of one (1) at each location or access point per direction of travel. (e.g., One way ingress driveways are allowed one (1) sign, two-way driveways are permitted two (2) signs.
Placement:	Building-mounted directional signs must be affixed flat against the building wall, no higher than the 1st floor.
Sign Height:	Building Mounted: Max 8' from grade Freestanding: Max 3' from grade
Sign Area:	3 sq. ft. per face
Illumination:	Internal illumination or non-illuminated, only

D. DIRECTORY AND NAMEPLATE SIGNS



DEFINITION:
 A single sign comprised of uniform individual signs placed or displayed in sequence and which may provide information in a list, roster, or directory format; generally a sign listing the names and/or use, or location of more than one business, activity or professional office conducted within a building, group of buildings or commercial center.

ZONING DISTRICTS ALLOWED:

See Figure 6.9.1

SIGN SPECIFICATIONS:

Number of Signs:	1 per address unless the street frontage of said institution exceeds one hundred (100) feet, then one (1) sign for each hundred (100) feet is allowed but in no event more than three (3) such signs per address.
Placement:	May be building mounted or mounted on a low profile freestanding sign
Sign Height:	Max 6' above grade
Sign Area:	Max 16 sq. ft.
Illumination:	Non-illuminated, Internally-illuminated or indirectly illuminated

OTHER FUNCTIONAL STANDARDS:

Directory signs may be placed at points nearest pedestrian entry to businesses within a multi-tenant development and/or within (pedestrian) open spaces.
 A nameplate shall only provide the name, address or logo of an owner, tenant, and/or the building to which it is affixed.
 Nameplates shall consist of either a panel or individual characters applied to building walls within 4 feet of an entrance to the building.

E. DISPLAY CASE

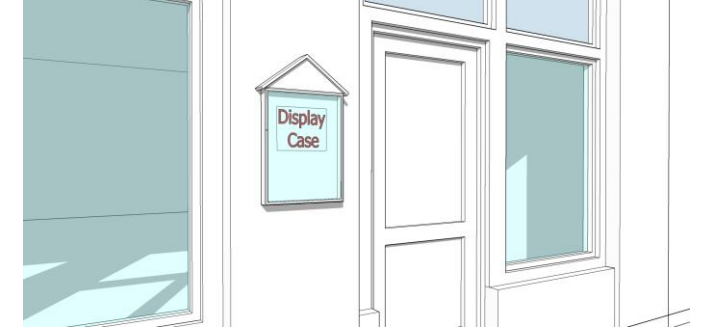

DEFINITION:
 A wall mounted, lockable, framed cabinet with a transparent window to display a changeable menu or list of event show times. Display cases are intended to be viewed at close range by pedestrians.

ZONING DISTRICTS ALLOWED:

See Figure 6.9.1

SIGN SPECIFICATIONS:

Number of Signs:	1 per 4 business; 4 max. for theaters per frontage.
Placement:	Shall be attached to the building wall on the primary or secondary frontage.
Sign Height:	Top of sign case shall not exceed 7 feet from grade.
Sign Width:	4 feet max.
Sign Area:	6 feet max.
Illumination:	Non-illuminated, or illuminated from inside the display case.

OTHER FUNCTIONAL STANDARDS:

Outdoor display cases for theaters may be larger but shall not exceed 12 sq. ft.

DRAFT

FIGURE 6.9.4 - PERMANENT PRINCIPAL SIGN STANDARDS

A. AWNING AND CANOPY SIGNS



DEFINITION:

A sign suspended from, attached to, supported from or forms part of a roof-like cover made of canvas or similar material which projects from the wall of a building for the purpose of shielding a doorway or window from the elements, not including a marquee. (An awning or canopy may or may not have signage.)

ZONING DISTRICTS ALLOWED:

See Figure 6.9.2

SIGN SPECIFICATIONS:

Number of Signs:	1 per business unit
Placement:	Top of awning may not extend above the bottom of the second story window of building. Canopy sign must be 10' min. from another canopy sign
Sign Height:	Max. 10' from grade to sign bottom Min. clearance above sidewalk 8.'
Sign Area:	The lesser of 1 sq. ft. of sign area per linear foot of awning width; or 75% of valance or face and/or 25% of the sloping plane
Sign Lettering:	5" min.; 10" max. of awning valance 18" max. of sloping plane
Illumination:	Canopies may be non-illuminated, internally-illuminated or indirectly illuminated If sign letters or logos are placed on the awning, only the face area containing the letters or logos may be illuminated. All illumination must be internal behind the surface of the awning/canopy.

OTHER FUNCTIONAL STANDARDS:

Signage on canopy shall be limited to the face or may project above.

Awning signs shall not be internally illuminated or backlit.
Canopy signs may be backlit.

DRAFT

B. BRACKET SIGNS

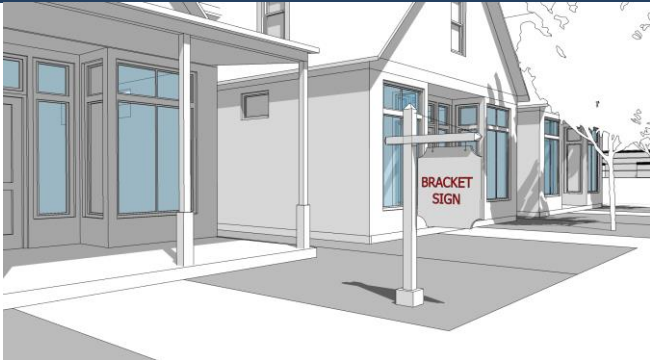

DEFINITION:

A freestanding sign attached to the ground by one or more support structures that is not higher than 5 feet and hangs from a bracket or support.

ZONING DISTRICTS ALLOWED:

See Figure 6.9.2

SIGN SPECIFICATIONS:

Number of Signs:	1 per shopfront
Placement:	Within the Sign Band
Sign Area:	9 Square Feet Maximum
Sign Structure Height:	5 Feet Maximum
Sign Area Height:	3 Feet Maximum
Sign Area Width:	3 Feet Maximum
Sign Structure Area Depth:	6 Inches Maximum

Illumination:	Band signs may be externally illuminated or backlit. Neon is permitted
---------------	---

OTHER FUNCTIONAL STANDARDS:

A bracket sign must be located at least 25 feet from another bracket sign.

The hanging bracket must be an integral part of the sign design.

A bracket sign can only be externally illuminated in accordance with Section 6.XX.

C. BLADE AND PROJECTING SIGNS



DEFINITION:

A building mounted sign attached to, and extending from, a building or support beam in whole or in part which extends beyond said building.

ZONING DISTRICTS ALLOWED:

See Figure 6.9.2

SIGN SPECIFICATIONS:

Number of Signs:	1 per business unit
Placement:	Projecting signs may encroach into the public right-of-way but shall not be located within 3' to the closest curb line. Sign shall be mounted a min. of 6" away from the building.
Sign Height:	Min 10' from grade to the bottom of the sign.
Sign Area:	Max 20 sq. ft. for each business unit. Wall signs are counted toward total signage area limit for the building.
Illumination:	Non-illuminated or externally illuminated. Down-directed, fully-shielded fixtures only. Accent lighting may consist of special lighting strips (non-scrolling or non-flashing LED or neon) in order to highlight logos or individual letters but does not dominate sign and shall not be considered internal illumination for the purposes of this section.

OTHER FUNCTIONAL STANDARDS:

Blade signs may be double-sided

Blade signs shall be permitted only for uses that have a principal entrance on the first floor.

6 sq. ft. max. sign area

4' max. sign width and height

8" max. letter height

Clear Height: 8' min.; 14' max. measured from the street grade to the top of the light standard or supporting standards, whichever is greater.

All signs overhanging a public way must be covered by an insurance policy naming the Town of Winchendon as coinsured for an amount to be established by the Town, evidence of which must be provided upon application for a sign permit from the Department of Inspectional Services.

D. FREESTANDING SIGNS

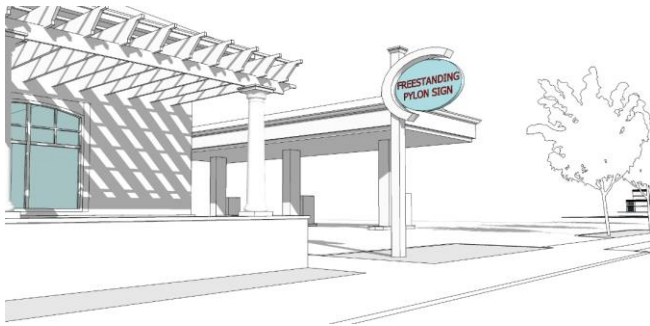

DEFINITION:

A sign (not including sandwich board signs) that is erected or mounted on its own self-supporting permanent structure or base detached from any supporting elements of a building.

ZONING DISTRICTS ALLOWED:

See Figure 6.9.2

SIGN SPECIFICATIONS:

Number of Signs:	1 for each street frontage maximum
	For home occupations: Max 1 sign
Placement:	When more than 1 freestanding sign is proposed on a site with multiple frontages, a minimum of 60 linear feet shall separate each sign. No portion may project into, over or otherwise encroach on a public right of way. Freestanding signs must have a 6' min setback from any interior side lot line and 30' from any residential zoning district
Sign Height:	Max. 10 ft above grade
Sign Area:	Max 40 sq. ft. When only 1 is proposed where 2 are permitted, the maximum sign area may be increased subject to approval and a release of rights to additional freestanding signs for the duration of use of the single larger sign, evidenced by a recordable form of acceptance signed by the property owner.
Illumination:	Permitted per requirements in Section 3263 C.
Landscaping:	Required landscaped area around base of the sign equal to 12 sq. ft. consisting of shrubs and/or perennial ground cover plants on permeable ground cover or raised bed with sod and plantings.

DRAFT

D. FREESTANDING SIGNS, Continued

OTHER FUNCTIONAL STANDARDS:

General:

Freestanding signs may be double-sided.

Freestanding signs may not be located in the public R.O.W.

Freestanding signs may be externally illuminated or backlit.

Banks:

Total sign area not to exceed 1 1/2 sq. ft. per 1 linear foot of building frontage.

Freestanding or ground sign max. 40 sq. ft.

Freestanding or ground sign max. 10 from grade to bottom of sign.

1 freestanding or ground sign per business.

Gas/Service Stations:

Freestanding sign max. of 30 sq. ft.; 1 max. per street frontage.

Ground signs and monument signs may be substituted for free standing signs.

Electronic display signs showing gas prices may be incorporated into freestanding signage and may be double-faced.

Gas Pump/Service Island - Canopy sign max. of 50 sq. ft. for each side of the service island canopy. Signs shall extend horizontally a max. of 80% of the width of the service island canopy on which it is displayed.

Freestanding and Gas Pump/Service Island signs may be non-illuminated, internally-illuminated, or indirectly illuminated.

E. VERTICAL BLADE/BANNER SIGNS



DEFINITION:

A tall, narrow, two-sided sign that is attached to and projecting perpendicularly from the facade of a building that identifies a commercial establishment. Vertical blade/ banner signs are intended to be viewed by pedestrians and motorists from a distance.

ZONING DISTRICTS ALLOWED:

See Figure 6.9.2

SIGN SPECIFICATIONS:

Number of Signs:	1 sign per 15 feet of façade width; 4 signs max.
Placement:	Signs shall be placed above the first story. Signs may encroach into the public right-of-way but shall not project more than 3' from the building facade. Sign shall be mounted a minimum of 6" away from the building facade.
Sign Height:	10 feet max.
Sign Width:	4 feet max.
Sign Area:	Max 20 sq. ft. for each business unit. Wall signs are counted toward total signage area limit for the building.
Sign Lettering:	75% of sign width maximum
Illumination:	Non-illuminated or externally illuminated. Down-directed, fully-shielded fixtures only.

OTHER FUNCTIONAL STANDARDS:

Vertical Blade/Banner signs may be double-sided

Blade signs shall be permitted only for uses on site.

No portion of the sign may project above the roof-line of the facade to which it is attached.

Information type is limited to business name and logo. Additional information is prohibited.

F. MARQUEE SIGNS



DEFINITION:

A sign painted on, attached to, or supported by a marquee—a permanent roof-like shelter, either open or covered, extending from part or all of a building face and constructed of some durable material which may or may not project over a public right-of-way.

ZONING DISTRICTS ALLOWED:

See Figure 6.9.2

SIGN SPECIFICATIONS:

Number of Signs:	Max. 1 per marquee per building.
Placement:	Primary facades only
Sign Height:	Min 10' from grade to bottom of the sign.
Sign Area:	Max 75% of marquee structure's width and height. Marquees signs counts toward total signage area limit for the building.
Projection:	6' min./10' max.

OTHER FUNCTIONAL STANDARDS:

Max. width shall be the width of the building frontage

Max. height of the sign is 50% of the first story height

Min. distance from the curb is 3'

New marquee signs shall be allowed only for theaters, performing arts venues, and sports arenas.

Marquee signs shall be located above the principal entrance of the building.

Marquee signs shall be cantilevered or supported from above; Columns or posts are prohibited.

Changeable message boards with removal physical lettering or electronic message displays may be permitted.

G. SUSPENDED SIGNS



DEFINITION:

A small, two-sided sign mounted to the underside of an awning, canopy, or roof of a porch that identifies a commercial establishment. Suspended signs are intended to be viewed by pedestrians at close range on the same side of the street.

ZONING DISTRICTS ALLOWED:

See Figure 6.9.2

SIGN SPECIFICATIONS:

Number of Signs:	1 per business unit
Placement:	A suspended sign may not extend beyond the edge of the awning or canopy it is mounted below. Clear height over the sidewalk is 8' min. Information type is limited to business name or logo. Additional information is prohibited.
Sign Height:	3 feet max
Sign Width:	3 feet max
Sign Area:	4 sq. ft. per side max.

Illumination: Non-illuminated or externally illuminated. Down-directed, fully-shielded fixtures only.
Accent lighting may consist of special lighting strips (non-scrolling or non-flashing LED or neon) in order to highlight logos or individual letters but does not dominate sign and shall not be considered internal illumination for the purposes of this section.

H. WALL MURALS

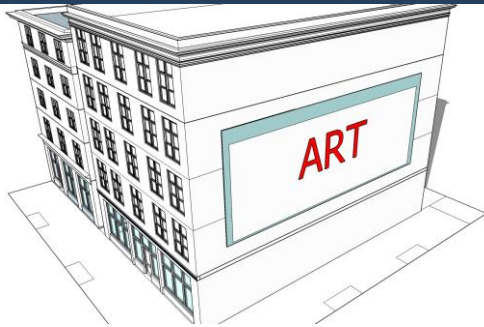

DEFINITION:

A sign that is directly painted on to the exterior wall of a building or screen printed, sewn, or adhered onto a canvas-like material that is mounted flush with the facade of a building that identifies a commercial establishment. Wall murals are intended to be viewed by pedestrians and motor vehicles from a distance.

ZONING DISTRICTS ALLOWED:

See Figure 6.9.2

SIGN SPECIFICATIONS:

Number of Signs:	1 per building
Placement:	On the building façade in a space generally visible to the public.
Sign Area:	1,000 sq. ft. max.
Sign Height:	50 feet max.
Sign Width:	50 feet max.
Height above the Ground:	1 story min.
Illumination:	Only external illumination is permitted.

OTHER FUNCTIONAL STANDARDS:

Lettering or logos must be limited to no more than 20% of the surface area of the wall mural.
Requires Special Permit from Planning Board

I. WINDOW SIGNS



DEFINITION:

Any non-illuminated or electronic/electrical static sign (with the exception of neon which shall be permitted as a window sign) which is (a) painted on, applied to, attached to or projected upon the glass area of a building, including doors, whose identification, message, symbol, insignia, visual representation, logo type, or any other form which communicates information is intended to be read from off-premises, contiguous property or a public right-of-way and/or (b) affixed to or within twelve (12) inches of windows of a building, whether temporary or permanent, which may be viewed from the exterior of the building.

ZONING DISTRICTS ALLOWED:

See Figure 6.9.2

SIGN SPECIFICATIONS:

Number of Signs:	1 per window and/or 1 per door max.
Placement:	3' min. height from sidewalk to bottom of the sign. See definition above.
Sign Area:	25% of the window area max. Window signs count toward total signage area limit for the building.
Sign Lettering:	18" max lettering height.

Illumination: Window signs shall not be illuminated however the use of neon is otherwise permitted

OTHER FUNCTIONAL STANDARDS:

Characters and logos shall be placed directly on the window or hang no more than 12" from the glass.
Items placed more than 12" from the glass shall not be considered a sign.

Information type is limited to business name, logo, hours of operations, and product types.

Window signs shall not interfere with the primary function of the window, which is to enable pedestrians and public safety personnel to see through windows into the premises and view product display.

J. WALL SIGNS



DEFINITION:

A sign attached to, painted on or erected against a wall, parapet, fascia, or a building or structure with the exposed face of the sign in a plane parallel to the vertical face of the building or structure.

ZONING DISTRICTS ALLOWED:

See Figure 6.9.2

SIGN SPECIFICATIONS:

Number of Signs:	One (1) wall is sign permitted per business frontage on a Primary or Secondary Street in the DESIGNATED ZONING DISTRICT.
Placement:	Wall sign shall project a maximum of 15 inches from building wall. Shall extend horizontally a maximum of 80% of the width of the building wall on which it is displayed.
Sign Area:	Max of 1 sq. ft. for each linear foot of primary business façade of each business unit. If business has frontage on two or more streets, the primary façade contains the primary entrance. Max ½ sq. ft. for each linear foot of façade on side with secondary entrances. Two or more businesses served by a single common building entrance are considered 1 business for sign computation purposes; Max 2 sq. ft. for each linear foot of building frontage for the entrance.

OTHER FUNCTIONAL STANDARDS:

Banks:

Wall sign max. 1 sq. ft. of sign area per linear foot of building frontage.

Wall signs max. 10' above grade to bottom of sign.

1 Wall sign per business frontage.

Wall signs may be non-illuminated, internally-illuminated, or indirectly illuminated.

The sign shall not obscure architectural features of the building (including but not limited to cornices, lintels, transoms) to which the sign is attached.

Gas/Service Stations:

Building wall sign max. 1 sq. ft. for each linear foot of building frontage.

No part of a wall sign shall extend above a roofline.

Wall signs may project a max. of 15" from a service island canopy.

Wall signs may be non-illuminated, internally-illuminated, or indirectly illuminated.

General:

Overall Dimensions: Each wall sign may not exceed 50 feet in length, 4 feet in width, and 80 square feet in area.

Sign length maximum of 50 feet and sign width maximum of 3 feet in the DESIGNATED ZONING DISTRICT.

Height above ground: The top of the sign shall be no more than the lesser of the floor level of the second floor or 25' in the DESIGNATED ZONING DISTRICT.

Wall signs may be externally illuminated or backlit in the DESIGNATED ZONING DISTRICT.

Neon wall signs are permitted in in the DESIGNATED ZONING DISTRICT by Special Permit from the Planning Board.

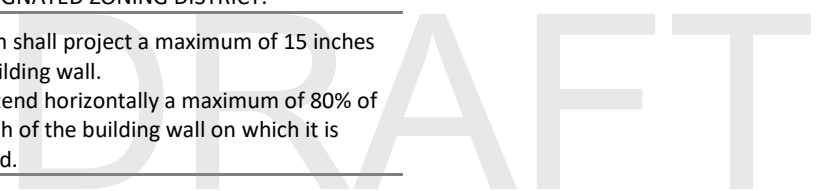

6.10. TEMPORARY SIGNS

COMMENTARY: The 2015 U.S. Supreme Court ruling in *Reed v. Town of Gilbert, Arizona* relates to content-neutrality and on-premises vs off-premises signs. The following is a brief synopsis of the ruling related to these issues:

Content-Neutrality: The U.S. Supreme Court, in its 2015 ruling in *Reed v. Town of Gilbert, Arizona*, made it clear that for a sign regulation to be considered “content-neutral”, you should not have to read the sign to determine what type of sign it is, or how to regulate the sign. Because of *Reed*, real-estate, election, construction signs, etc. are now considered content-based signs because you define them by their content. Content-neutrality also impacts the regulation of all signs, not just temporary signs, and often becomes a question of interpretation.

Content-neutral sign regulations define signs based on their size, height, structure, placement, material, shape, or other characteristics, not content. While some court cases before *Reed* allowed the regulation of a limited number of content-based signs, such as real estate or political signs, these decisions have been effectively overturned by the *Reed* decision and should no longer be considered good law. In light of the *Reed* decision, the best approach is to eliminate all content-based language from the sign regulations, with the only exceptions being signs that must be defined by content in order to achieve a compelling governmental interest.

On-Premises versus Off-Premise Signs: The *Reed* decision left uncertainty as to the legality of regulations that consider the content of signs to determine if the sign is an on-premise sign or an off-premise sign. This is important for permanent signage because of a general concern about allowing billboard signs, which are traditionally off-premise signs. With temporary signs, this distinction may be less important, as discussed earlier, and may only be applicable when addressing larger temporary signs, such as balloon signs.

A. Terminology.

1. Temporary Sign. Portable signs or any sign not permanently embedded in the ground, or not permanently affixed to a building or sign structure, which is permanently embedded in the ground, are considered temporary signs.

B. Permitted Temporary Signs by Zoning District.

FIGURE 6.10.1 – PERMITTED TEMPORARY SIGNS				
Zoning District	R	C	I	PD
Window Signs				
Real Estate and Construction Signs				
Transient Event Signs				
Banners				
Vehicle Signs				
Other Temporary Signs				
Permitted by Right with Specifications under this Article Permitted only for approved home occupations, churches, schools, and related institutions intended for public access Permitted by Special Permit. See Special Permit Criteria under Section XXX				

C. Permitted Temporary Sign Standards. Unless otherwise specified, temporary signs are permitted for a maximum of sixty (60) total days, shall not be illuminated, and do not require a sign permit, but are subject to the following standards:

1. **Temporary Window Signs:** Temporary signs not meeting the requirements for permanent signs may advertise sales, special events, or changes in the nature of an operation and are restricted to devices made of paper, posterboard, cardboard, cloth, canvas, fabric, cardboard, or other light material placed behind display windows, or markings of removable paint or marker inscribed directly on glass, if such devices and markings cover not more than 30% of window area, are not permanently mounted, and are illuminated by building illumination only, but shall not otherwise be used to advertise a continuing or recurrent activity, and shall be removed within seven (7) days after the information they display is out of date or no longer relevant.
2. **Real Estate and Construction Signs:** A temporary sign may be erected during sale, lease, rental, or construction of a building or subdivision. Such sign shall not exceed (40) forty square feet in area for premises in the designated zoning district, and in other cases shall not exceed six (6) square feet in area in residential districts and ten (10) square feet in area in other nonresidential districts. Construction signs shall not be erected prior to the issuance of a building permit, or prior to commencement of work if said work does not require a building permit.
3. **Transient Event Signs:** Temporary signs which indicate garage or yard sales, bazaars, dinners, or other nonprofit events and similar occasional uses shall comply with the Winchendon General Ordinances, and any conditions imposed in granting of licenses for such events by the Selectboard.
4. **Banners:** A temporary banner or similar sign, if permitted by the Selectboard under its authority to control use of Town ways under General Ordinances may be placed above or across a public or private street or way upon such terms and conditions as the Selectboard shall determine. When a business newly opens, the **Zoning Enforcement officer** may as a condition of site plan approval allow the placement of a banner on the premises for a

period not to exceed two weeks.

- 5. **Vehicles:** A truck, trailer, or other vehicle shall be construed as a temporary sign, subject to the requirements applicable to permanent signs, if placed at a location especially prepared for display through special lighting or elevation, or in the case of commercial vehicles having lettering, logos, or similar devices, if such vehicles are placed at a location more prominent than a feasible alternative on the site for a cumulative total of ten(10) or more days following written order not to do so by the Inspector of Buildings. Appeal of actions or inactions under this provision may be brought to the Board of Appeals under 13.6 of the Zoning Bylaw.
- 6. **Other Temporary Signs.** To be determined by the **Zoning Enforcement officer.**

FIGURE 6.11.1 – ILLUSTRATIVE EXAMPLES OF TEMPORARY SIGNS



Balloon Signs & Air-Activated Graphics

Advertising Murals

Banner Signs



Feather Signs (or Teardrop Flag)

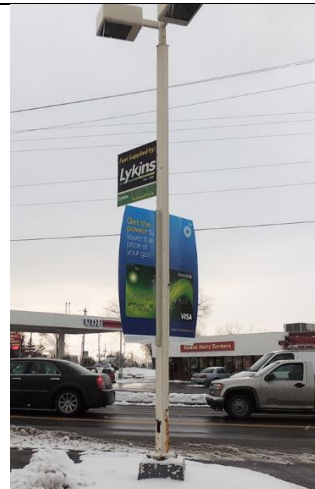

Light Pole or Support Pole Banners



People Signs



Portable Message Center Signs



Temporary Window Signs



Vehicle Signs & Wraps

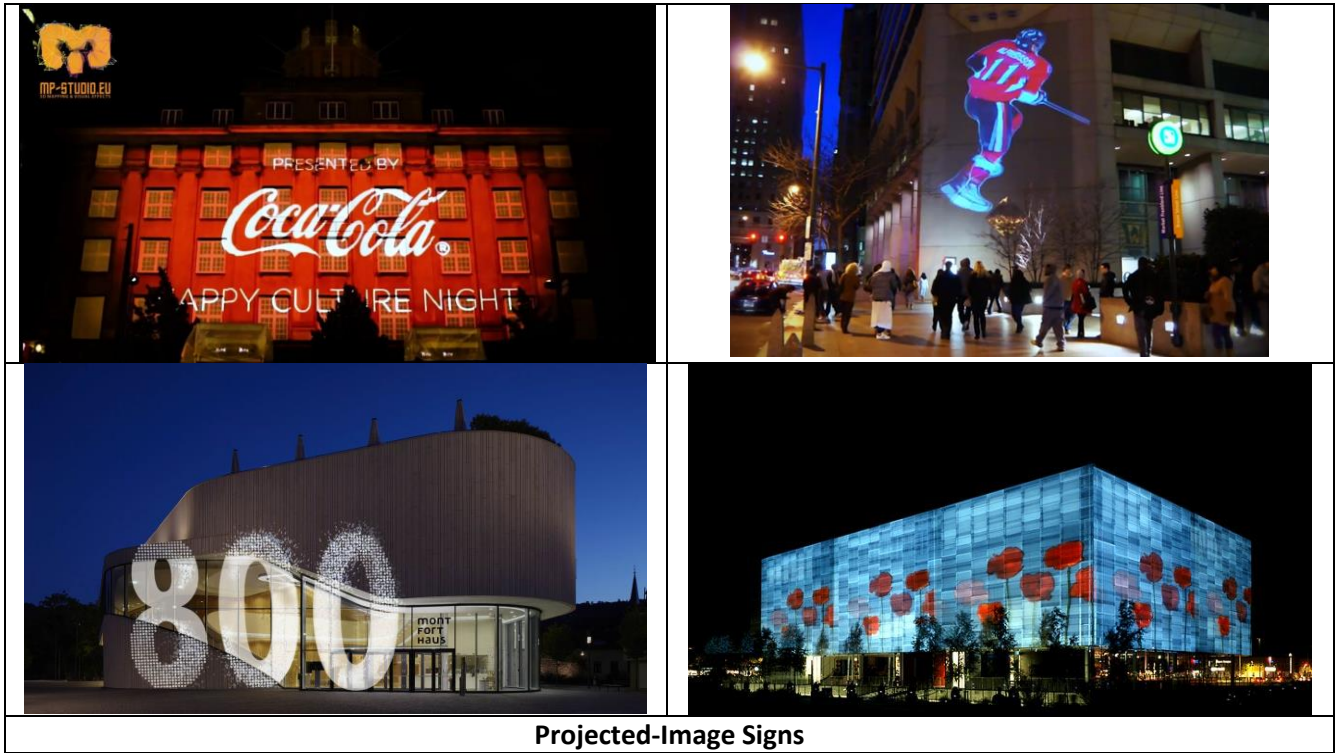

Projected-Image Signs

DRAFT



7.0 OUTDOOR AMENITY SPACE



7.1 GENERAL STANDARDS

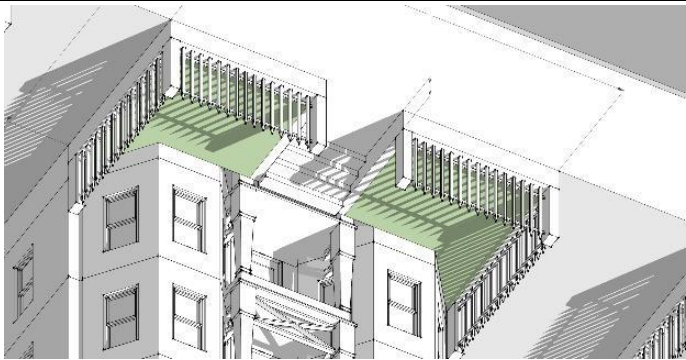

- A. **Outdoor Amenity Space Types.** Outdoor Amenity Spaces include the following types:
1. Civic Space (CS). This includes publicly-owned or controlled parks, active and passive recreation areas, civic buildings, and other gathering spaces that are fully accessible to the general public.
 2. Publicly Oriented Private Spaces (POPS). These are gathering spaces on private land primarily serving the residents, businesses, and patrons of a district or development, and accessible to the general public.
 3. Private Open Space (PS). This is open space associated with an individual building or development site and is not intended for public access.
- B. **Required Outdoor Amenity Space.** The required percentage of a development site dedicated to open space is identified for each zoning districts in **Section XXX of the Zoning Bylaw**.

7.2 OUTDOOR AMENITY SPACE DESIGN STANDARDS

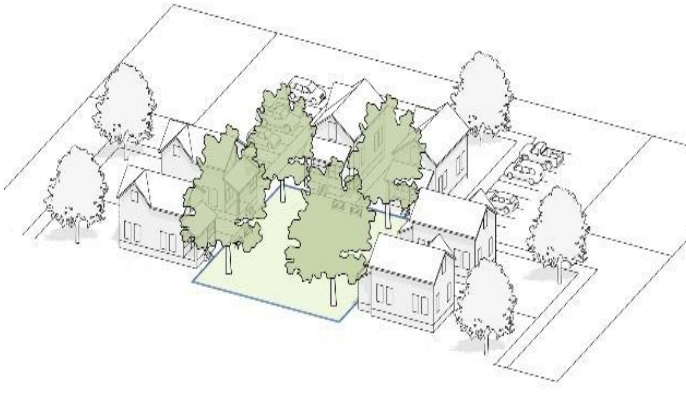
Outdoor Amenity Space types and associated design standards are identified in Table 7.2.1 below:

TABLE 7.2.1 - OUTDOOR AMENITY SPACE TYPES AND DESIGN STANDARDS	
Type	Description and General Design Standards
<p>A. Private Yard and Garden (PS)</p> 	<p><u>Description:</u> A private open space associated with multi-family or non-residential buildings not intended for public access.</p> <p><u>Design Standards:</u> Where applicable, a walkway should be provided between the public sidewalk and the primary building entrance.</p>
<p>B. Dooryard (PS)</p> 	<p><u>Description:</u> A private open space where the building façade is aligned close to the Street R.O.W. Line and defined by a low wall, decorative fence or hedge providing a strong spatial definition from the public sidewalk. The result is a small semi-private dooryard containing the principal entrance in the front yard. This type is commonly associated with ground-floor residential use</p> <p><u>Design Standards:</u> The dooryard may be slightly raised, sunken, or at-grade, and may be planted or landscaped. A paved walkway from the sidewalk to the front door is required.</p>
<p>C. Forecourt (POPS, PS)</p> 	<p><u>Description:</u> A private open space where a portion of the façade is aligned close to or at the Street R.O.W. Line, and the central portion of the façade is set back to create a courtyard with a principal entrance at-grade and space for gathering and circulation, or for outdoor shopping or restaurant seating. The forecourt may be planted or paved to join with the public sidewalk.</p> <p><u>Design Standards:</u> Forecourts should be a minimum width and depth of 12 feet; a maximum ratio of building height to forecourt width of 2:1; and enclosed by walls on 3 sides.</p>
<p>D. Community Garden (CS, POPS, PS)</p>	<p><u>Description:</u> An open space designed as individual garden plots available to residents for horticultural purposes, including storage</p>

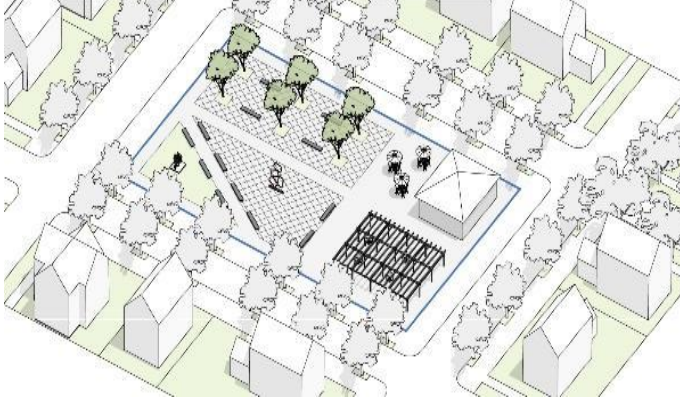
	<p>facilities for necessary equipment. Community gardens may be freestanding or incorporated as a subordinate feature of a community park, neighborhood or pocket park, or Development Site.</p> <p><u>Design Standards:</u> Community gardens should be a minimum of 5,000 S.F.</p>
<p>E. Courtyard (POPS, PS)</p>	<p><u>Description:</u> A courtyard (or court) is an enclosed open space that is open to the sky. They are often surrounded by a building or framed by buildings on at least 2 sides. Courtyards may include a variety of passive recreational activities, community gardens, and other amenities for community gatherings.</p> <p><u>Design Standards:</u> Courtyards should be a minimum of 3,000 S.F. in area and 40 feet in width.</p>
	<p><u>Description:</u> A common or green is a free-standing site with streets on all sides and landscape consisting of lawns, paths, and trees. This open space type is for active and passive recreation and gathering purposes.</p> <p><u>Design Standards:</u> Commons should be a minimum of 10,000 S.F.; 85% permeable surfaces; and 1 tree/2,000 SF on average.</p>
<p>F. Common or Green (CS, POPS)</p>	<p><u>Description:</u> A common or green is a free-standing site with streets on all sides and landscape consisting of lawns, paths, and trees. This open space type is for active and passive recreation and gathering purposes.</p> <p><u>Design Standards:</u> Commons should be a minimum of 10,000 S.F.; 85% permeable surfaces; and 1 tree/2,000 SF on average.</p>
	<p><u>Description:</u> An open space type designed for passive recreation, civic purposes, and commercial activities, with landscape consisting primarily of hardscape. Plazas are</p>
<p>G. Plaza or Square (CS, POPS)</p>	<p><u>Description:</u> An open space type designed for passive recreation, civic purposes, and commercial activities, with landscape consisting primarily of hardscape. Plazas are</p>

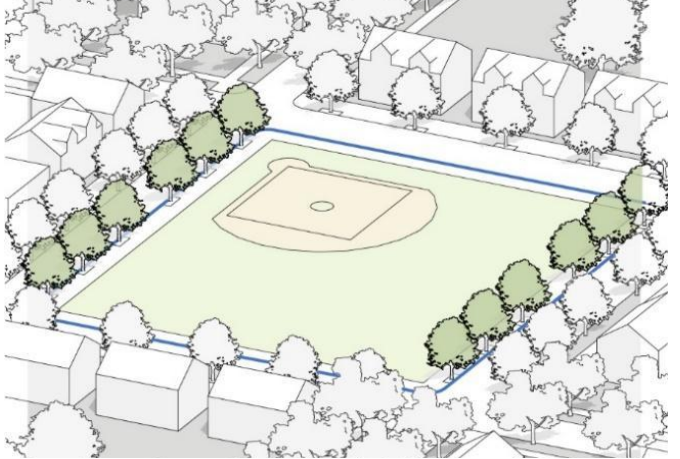
	<p>generally located in activity centers or the nexus of major circulation routes.</p> <p><u>Design Standards:</u> Squares should be a minimum of 5,000 S.F.; 50% permeable surfaces; 1 tree/2,000 SF on average; and include public seating.</p>
<p>H. Pocket Park or Playground (CS, POPS, PS)</p>	<p><u>Description:</u> An open space type designed for passive recreation consisting of vegetation, a place to sit outdoors, and playground equipment.</p> <p><u>Design Standards:</u> Pocket Parks should be a minimum of 800 S.F.; 80% permeable surfaces; and 1 tree/200 SF on average; and include seating and recreational equipment.</p>
	<p><u>Description:</u> A publicly accessible open space designed and equipped for active recreation and organized sports. Playing fields and courts may include grass, artificial turf, clay, dirt, stone dust, concrete, asphalt, ice or other pervious or impervious materials to support various sporting organizations and events.</p> <p><u>Design Standards:</u> <u>Size of Space:</u> 7,500 S.F. Min.; 5 Acres Max. <u>Furnishing:</u> Seating: 1 Seat/275 S.F. Min. <u>Landscape:</u> Landscaped Area: 20%</p>
<p>I. Athletic Field or Ball Court (CS, POPS)</p>	
	<p><u>Description:</u> An open space designed for active and passive recreation with features and facilities that support the community or</p>
<p>J. Neighborhood Park (CS, POPS)</p>	

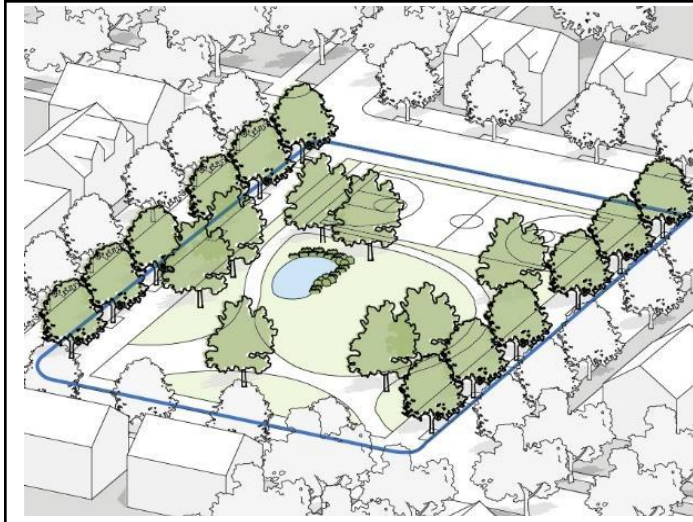

immediate neighborhood. Parks can include other Outdoor Amenity Spaces such as community gardens, recreation fields and courts, trails and pathway, swimming pools and water features, and other facilities intended for public events, gatherings, and organized activities.

Design Standards: Neighborhood Parks should be a minimum of 8,000 S.F.; 80% permeable surfaces; and 1 tree/350 SF on average.

K. Streetside Terrace (POPS)

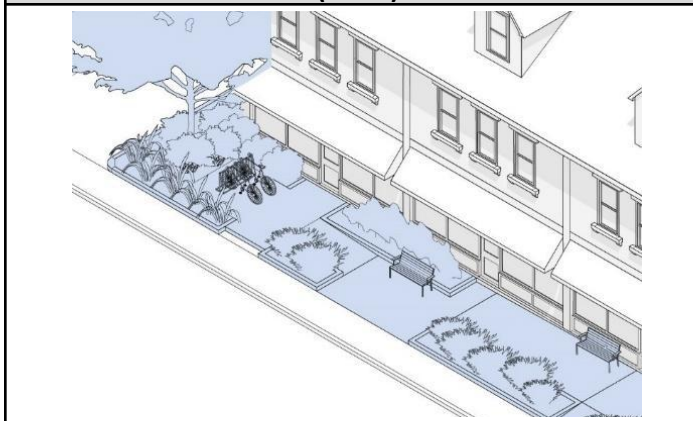

Description: An open space where the building façade is setback from the Street R.O. W. Line and the space between is occupied by a hardscape intended for use as an extension of the public sidewalk and outdoor amenity space such as for outdoor seating or displays. The space may also allow for public circulation along the façade and can be used to provide at-grade access or a grade change along a Street R.O.W. Line.

L. Rooftop Terrace (POPS, PS)

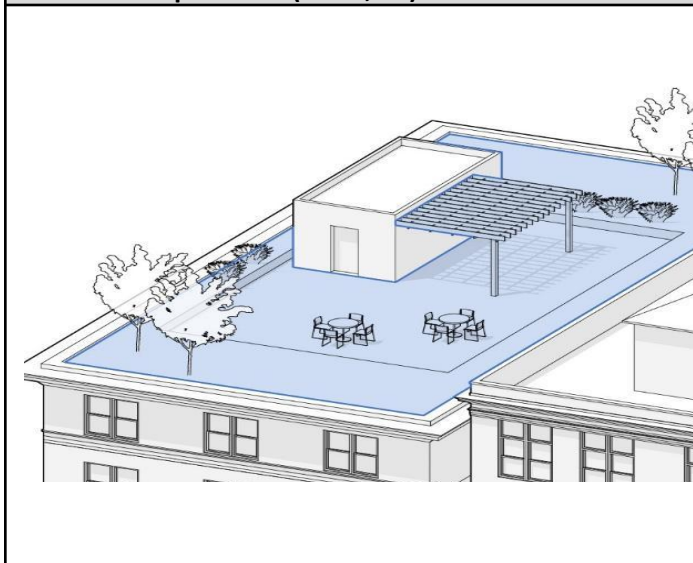

Description: A roofless, raised platform on the roof of a building that provides community gathering space such as a terrace, community garden, food and entertainment, or other outdoor amenities.

Design Standards: Terrace should be setback a minimum of 5 feet from any building wall and secured by a perimeter fence at least 4 feet tall.

M. Pedestrian Passage (CS, POPS)

Description: A paved or brick pedestrian connector between buildings. Pedestrian Passages provide direct connections between parking areas, buildings, streets, and

	<p>sidewalks. Pedestrian Passages may be covered by a roof, trellis, and may be lined by shopfronts.</p> <p>Design Standards: The minimum width should be 10 feet (A) with 5 feet of throughway for pedestrians (B); hard surface such as asphalt, concrete, or paver stones is required; lighting is required; landscaping is recommended.</p>
<p>N. Pathway (CS)</p>	<p>Description: A linear open space that may follow natural corridors providing unstructured and limited amounts of structured recreation. A pathway may be spatially defined by segment and include access to pedestrians, bicyclists, and other designated modes of transportation. Pathways may provide access and connections between natural areas, neighborhoods, villages, public facilities, and other points of interest.</p> <p>Design Standards: The minimum width should be 8 feet; Pathways shall be surfaced with stone dust, or asphalt.</p>
<p>O. Other Outdoor Amenity Space Types</p>	<p>Permitted by Special Permit by the Planning Board</p>

8.0 COMPLETE STREETS

8.1. INTENT

- A. To encourage “Complete Streets” that accommodate multiple modes of transportation, consistent with Winchendon’s character of traditional neighborhoods and town center, and safe and attractive to pedestrians and bicyclists.
- B. To ensure the development of a well-connected travel network, composed of direct and convenient routes that reinforce Winchendon as a walkable, bikeable, and human-scaled community.

8.2. APPLICATION

- A. **Public Infrastructure Projects.** These standards shall be considered in the design and utilization of new or redesigned public streets.
- B. **Private Participation.** Applicants for site plan approval for a development project, subdivision approval, building permit, or change of use may participate in partnership with the Town of Winchendon on the construction of streetscape improvements planned for public streets including the areas within the right-of-way between the vehicle lane and street line along the applicant’s property frontage. All improvements must be approved by the Board of Selectmen in consultation with the Planning Board and Department of Public Works.

8.3. STANDARDS FOR ALL THOROUGHFARES

- A. **Complete Street Zones and Components.** Figure 8.3.1 below identifies complete street components that are allowed in each segment of public realm zone which includes the public right-of-way and the building frontage area.
- B. **Complete Street Design and Construction Standards.** Public streets must be engineered and constructed in accordance with the Town of Winchendon Subdivision Regulations. In the absence of official standards, Thoroughfares must be designed and constructed according to the standards deemed to be appropriate by the Town Engineer and Planning Board. Figure 8.3.1 below provides design guidelines for new public streets in Winchendon.

FIGURE 8.3.1 - COMPLETE STREET ZONES AND COMPONENTS



STREET COMPONENT	Grey - Vehicle Throughway Zone	5. Street Enhancement Zone	4. Furnishing and Utility Zone	3. Pedestrian Throughway Zone	2. Public Frontage Zone	1. Building Frontage Zone
Motor Vehicle Travel Lanes	●					
Bicycle Facilities	●	●				
Crosswalks	●	●				
On-Street Parking Lanes		●				
Curb-Extensions		●				
Bus Facilities		●	●		●	●
Utilities/Green Infrastructure	●	●	●	●	●	●
Street Trees and Tree Pits		●	●		●	●
Public Seating		●	●		●	●
Bicycle Parking		●	●	●	●	●
Driveway and Alley Crossings		●	●	●	●	●
Sidewalks				●	●	●

8.4. STREET TYPES AND DESIGN ALTERNATIVES

A. Applicability. Figure 8.4.1 below identifies the types of streets and options for design consistent with the Town of Winchendon Subdivision Rules and Regulations. Design and construction standards shall apply as follows:

1. All new streets, whether publicly dedicated or privately held;
2. The reconstruction of elements of the public realm when the public realm has been disturbed by development; or
3. Substantial street reconstruction of a street.

B. Waiver. The Planning Board may waive requirements of a particular street type or apply another type when it finds that applying the requirements of Figure 8.4.1 in a particular instance is either practically infeasible or detrimental to the safety of people who walk or bike and these detrimental effects cannot be mitigated.

FIGURE 8.4.1 - COMPLETE STREET TYPES AND DESIGN OPTIONS			
Street Component	Town Center Street	Neighborhood Street	Access Street
<u>Right-Of-Way (B)</u>	50 Ft. Min.	40 Ft. Min.	24 Ft. Min.
Travel Lane (C-5)	11 Ft. Min.	10 Ft. Min.	10 Ft. Min.
Parking Lane (5)	8 Ft Minimum	1 Side or Informal	N/A
Bike Lanes	Optional/ 5 Ft. Min.	Sharrows/Informal	N/A
Multi-Purpose Path	N/A	N/A	N/A
<u>Sidewalks</u>			
Public Frontage Zone (2)	Optional/ 3 Ft. Min.	N/A	N/A
Throughway Zone (3)	5 Ft. Min.	4 Ft. Min.	1 Side/ 4 Ft. Min.
Furnishing/Utility Zone (4)	5 Ft. Min	4 Ft. Min.	N/A
Street Enhancement Zone (5)	Optional	N/A	N/A

8.5. VEHICLE THROUGHWAY ZONE

A. Design and Construction. A Vehicle Throughway must be designed and constructed in accordance with the Town of Winchendon’s Street and Sidewalk Design Standards and/or the Subdivision Regulations. In the absence of official standards, Thoroughfares must be designed and constructed according to standards deemed to be appropriate by the Town Engineer and Planning Board in accordance with the following standards

B. Travel Lanes.

1. Motor vehicle travel lanes may have a width between ten (10) feet and twelve (12) feet.
2. When two opposing motor vehicle lanes share space as part of a “yield street configuration,” the combined width of the travel lanes may be reduced to a minimum of 16 feet.
3. No more than two (2) motor vehicle travel lanes may be combined for any single direction of traffic flow.
4. Materials must be as following unless otherwise specified by the Department of Public Works.
 - (a) Pavement must be hot mix asphalt.
 - (b) The surface course must be 1.5” deep.
 - (c) The binder course of the pavement must be Geotextile plus 2.5” asphalt.
 - (d) The subbase must be 24” for poor to fair soils and 12” for good to excellent soils.
5. Pervious pavement may be acceptable if planned and implemented in consultation with the Department of Public Works and an engineer who has experience with pervious pavement, and established specifications such as those provided by the University of New Hampshire Stormwater Center Design Specifications for Porous Asphalt Pavements and Infiltration Beds.

C. Bicycle Travel Facilities.

1. Bicycle Travel Facilities may be located in the Vehicle Throughway Zone, or the Street Enhancement Zone. (For example, a separated bike lane may be located between on-street parking and the Furnishing and Utility Zone).
2. Separated Bicycle Lanes must be designed in accordance with the 2015 MassDOT Separated Bike Lane Planning and Design Guide or the latest version.
3. Bicycle throughways (bicycle lanes) may be constructed of hot mix asphalt or porous asphalt. Porous asphalt must be planned and implemented in consultation with the Department of Public Works and an engineer who has experience with pervious pavement, and established specifications such as those provided by the University of New Hampshire Stormwater Center Design Specifications for Porous Asphalt Pavements and Infiltration Beds.

D. Crosswalks.

1. The Continental Crosswalk pattern is preferred by the Town of Winchendon.

2. Crosswalks must be aligned with the pedestrian throughways to which they are connected, unless granted a waiver by the Planning Board by Site Plan Approval.
3. Where an adjacent pedestrian throughway is wider than the prescribed width of the crosswalk, the crosswalk markings should be widened to match the adjacent pedestrian throughway.

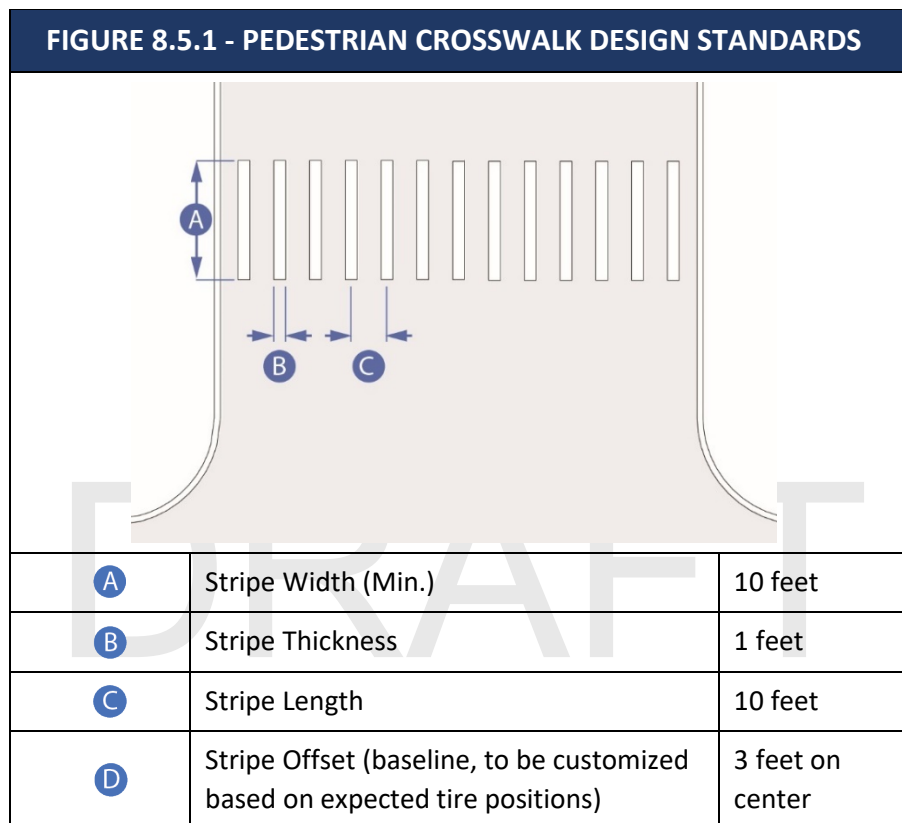

4. Crosswalks must be thermoplastic unless epoxy is approved by the Department of Public Works. The Planning Board may allow flush granite and a mix of materials such as stamped concrete with flush granite to create visual cues and reinforce a specific design character.

8.6. STREET ENHANCEMENT ZONE

A. Overview. The street enhancement zone includes the area between the Furnishing & Utility Zone and the edge of motor vehicle and bicycle travel lanes. Components in this area include temporary activation uses like parklets and food trucks (where allowed – See Section 9 – Public Realm Activation), and permanent components such as on-street parking spaces, stormwater infiltration areas, curb extensions, and crosswalks. The Street Enhancement Zone

can include some of the same elements as the Furnishing & Utility Zone, such as public seating, bike racks, and planting.

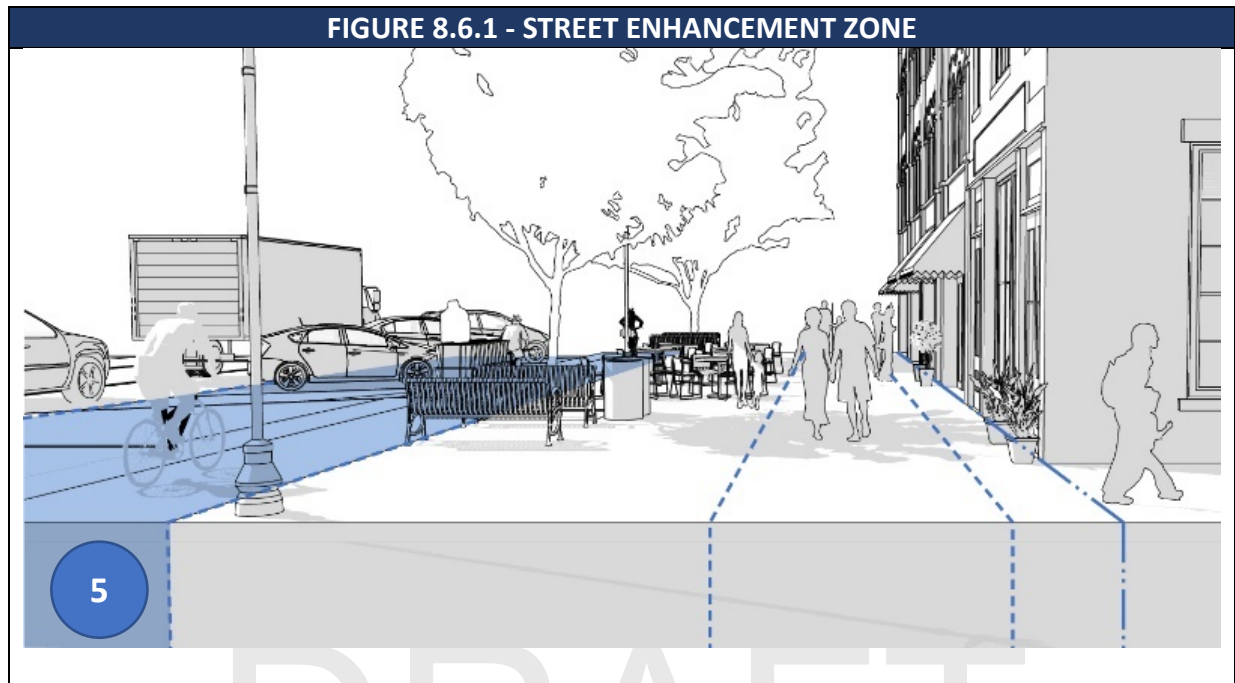

B. On-Street Parking Lanes.

1. Where motor vehicle parking lanes are desired, they must be eight (8) feet wide minimum and twenty-two (22) feet long maximum for parallel parking spaces; and nine (9) feet wide and eighteen (18) feet long for angled parking spaces.
2. Angled on-street parking may be 60° or 90° angle parking. Sixty degree (60°) angle parking may be head-in or reverse-angle parking per the recommendation of the DPW.
3. Gutter seams, drainage inlets, and utility covers must be flush with the pavement surface and oriented to prevent conflicts with bicycle tires.

C. Curb Extensions.

1. A curb extension is required at mid-block crossings and may be required at intersections as deemed necessary by the DPW based on traffic volumes, visibility, accident history, and required vehicle turning radii. A curb extension should only be installed where motor vehicle traffic deflection is provided through on-street parking, a parklet, another curbside use, or pavement markings.

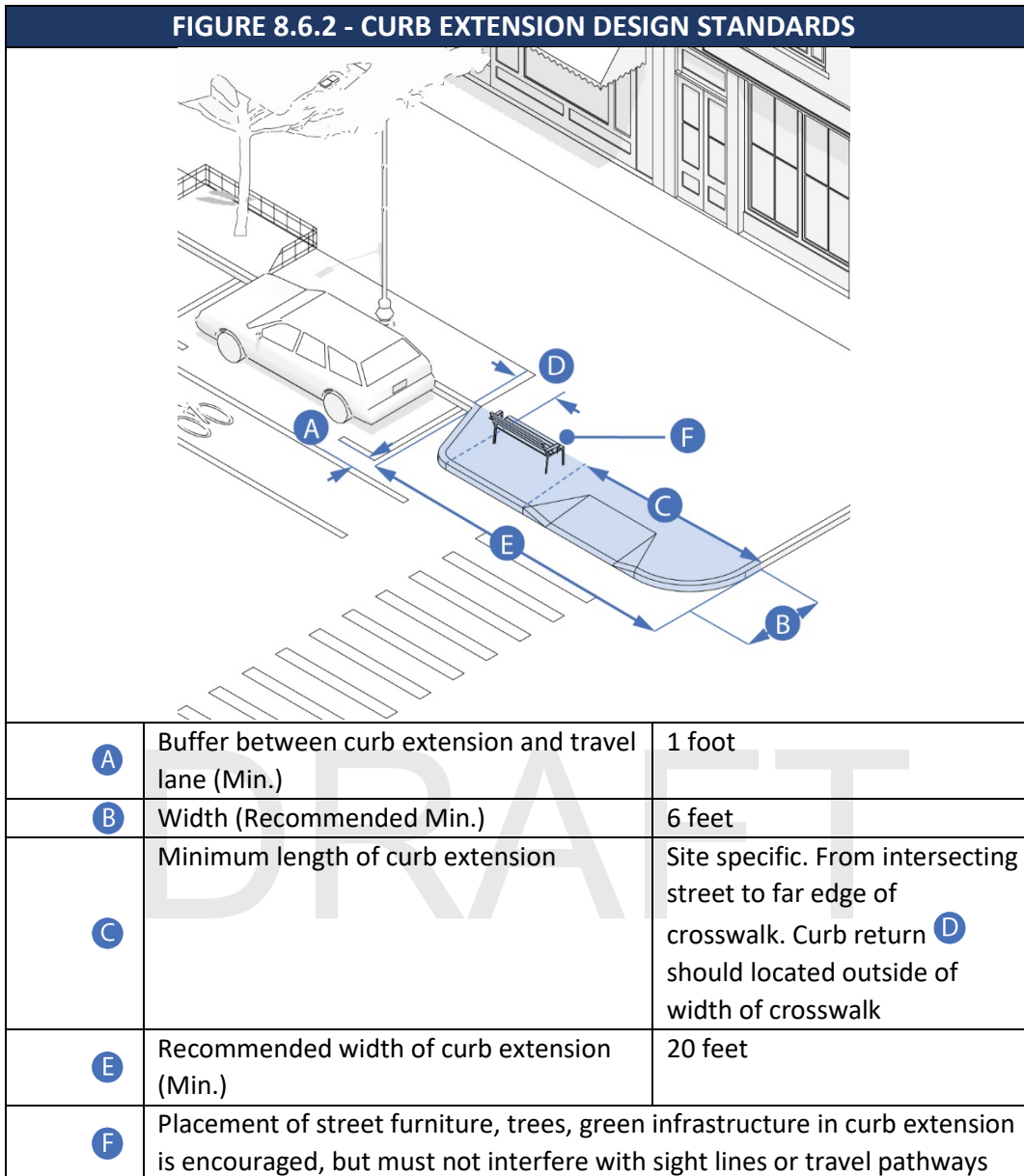

2. A curb extension should occupy as much of the width of the parking lane as is practicable, while providing a minimum of 1 foot between the edge of the curb extension and adjacent motor vehicle or bicycle lanes. The recommended minimum width of a curb extension is 6 feet. When a curb extension includes a streetside gutter adjacent to a bicycle lane, the curb extension must be set back so that the gutter does not extend into the bike lane.
3. A curb extension should be, at a minimum, as long as the width of the adjoining crosswalk with the curb returns from the curb extension located outside of the width of the crosswalk. Where possible, a curb extension should be 20 feet long to restrict parking within 20 feet of an intersection.

4. Where a sidewalk extension includes a bus stop, the design of the sidewalk extension must follow the guidelines for Boarding Bulb Stops found in the latest edition of the NATCO Transit Street Design Guide.
5. Incorporation of street furniture, trees, and/or green infrastructure into curb extensions is encouraged. However, these elements must not interfere with pedestrian flow, emergency access, or visibility between pedestrians and other roadway users.

D. Bus Facilities.

1. Where bus stops exist, site design and ancillary improvements to the public realm should ensure:
 - a) Adequate sight lines for bus stop signage,
 - b) Minimization of circulation conflicts between bus stops users and vehicles or pedestrians using the adjacent public realm or site,
 - c) Attractive surroundings and amenities for bus riders, including where appropriate covered bus shelters with illumination and adequate seating for anticipated riders, bicycle racks, and information kiosks.
2. Bus Pullout design should be consistent with the guidelines found in the latest edition of the NATCO Transit Street Design Guide. The “Curbside Pull-Out Stop” is the preferred bus stop type in the Town, except when the DPW and Planning Board find another bus stop type is preferable.

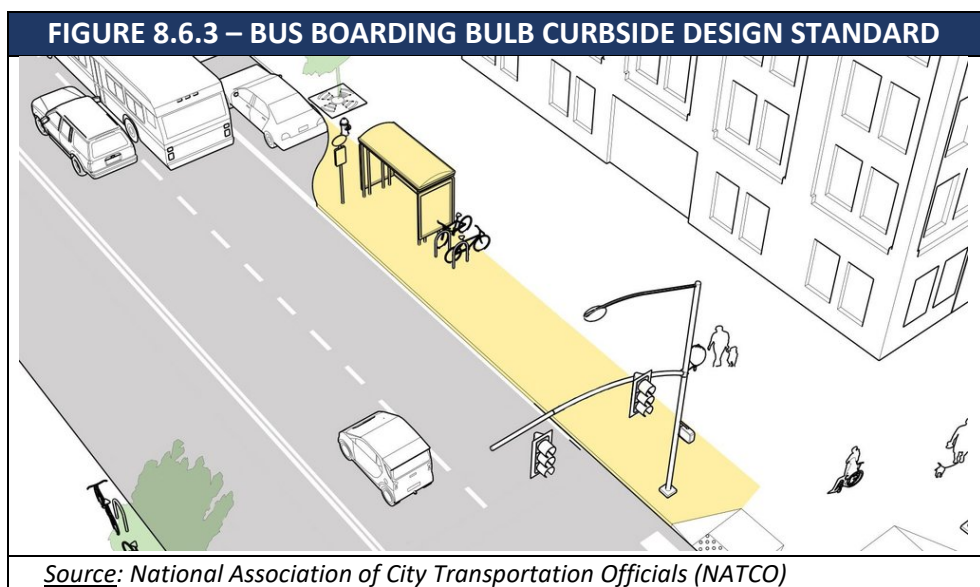

E. Utilities.

1. The design and construction of all water and sewer utilities, stormwater management infrastructure, public lighting, and public furniture is subject to review and approval by relevant Town departments and/or adopted standards by the Planning Board and/or Department of Public Works.
2. All new electrical, communications, and cable utilities must be located underground.

F. Green Infrastructure.

1. Green Infrastructure is encouraged wherever possible, subject to the standards found in **Section XX of the Zoning Bylaw/Subdivision Regulations.**

8.7. FURNISHING & UTILITY ZONE

A. Overview. The Furnishing & Utility Zone is the area of the sidewalk where pedestrians might pause or rest on benches or cafe seating and where many of the utilities, like lighting and hydrants, are located. This is the area typically planted with street trees. The Furnishing & Utility Zone varies in width.

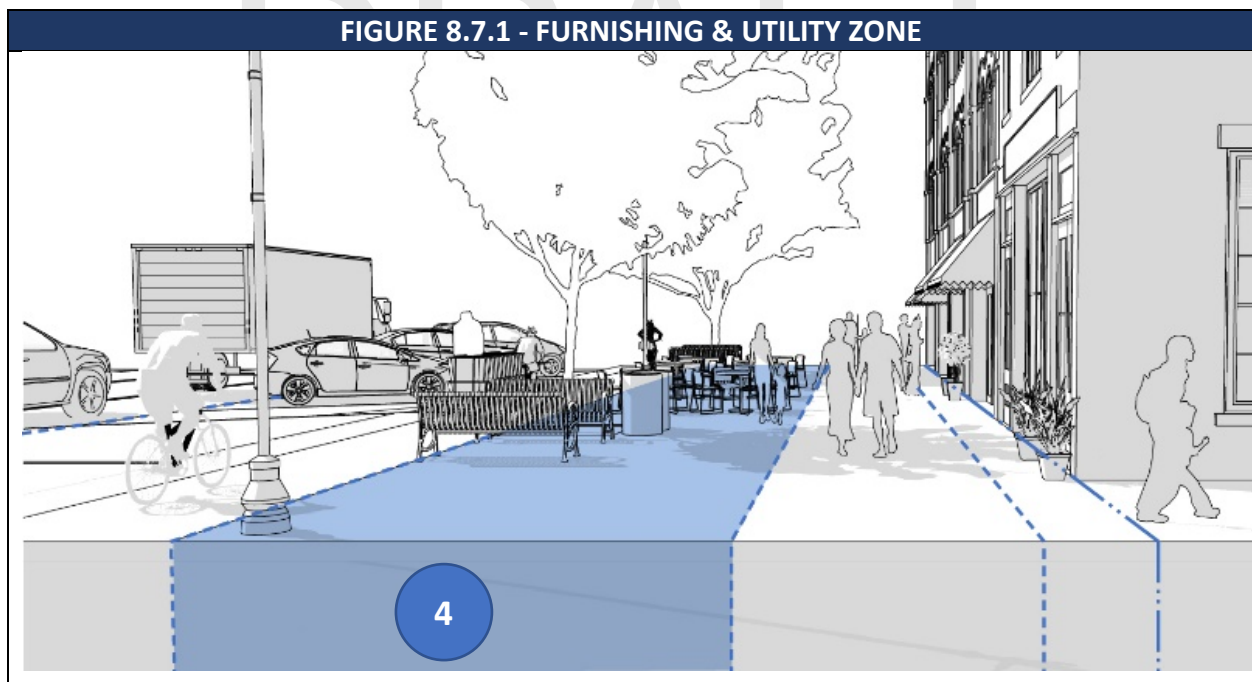

B. Width. The required width of the Furnishing & Utility Zone is determined by street type. See Section 8.4 above.

C. Surfacing. Unless otherwise specified in these regulations or in specifications adopted by

DPW, the Furnishing & Utility Zone must be surfaced with concrete and edged with a granite curb on the streetside. Pervious concrete unit paving, per the specifications of the DPW, may be used over areas contributing to street tree minimum recommended soil volumes (see Street Tree and Tree Pit Standards).

D. Street Trees and Tree Pits.

1. Installation Requirements.

- a) New street trees should be planted within the Furnishing & Utility Zone to fill any gaps greater than 50 feet long between existing street trees. The Planning Board may grant a waiver from this requirement based on numbers 4, 5, 6, or 7 below.
- b) Street trees should be planted in a regularly spaced pattern with trees aligned parallel to the curb. Trees should generally be spaced twenty to thirty (20 - 30) feet on center depending on species, and no greater than forty (40) feet on center.
- c) When trees are planted both in the Furnishing & Utility Zone and in Public Frontage Zone or the Building Frontage Zone, the trees on either side of the Pedestrian Throughway should be aligned in an allee pattern, when possible.
- d) Spacing of trees planted in the Furnishing & Utility Zone or Building Frontage Zone may be adjusted to avoid obscuring windows, doors, and signage.
- e) A tree must not be planted in a location where it will block passage to a doorway or stairs, or where it will narrow a Throughway to less than the minimum dimensions required by this ordinance.
- f) The Planning Board may, at its discretion, grant a waiver from street tree requirements when the tree would obstruct a terminated vista or when a tree would obstruct views to or into a civic space.
- g) Street Trees must be planted at least five (5) feet from fire hydrants, six (6) feet from street signs, seven (7) feet from curb cuts, and thirty (30) feet from stop signs. The edges of tree planting beds must be at least two (2) feet from gas, electric, water, and sewer lines, and at least four (4) feet from oil fill pipes.
- h) A tree pit must be a minimum of five (5) feet wide (dimension perpendicular to curb) and ten (10) feet long (dimension along curb). The Planning Board may grant a waiver from these specific dimensions, if this configuration is not possible due to site constraints, and an alternate configuration that amounts to a minimum of 50 square feet of surface is provided.
- i) A tree should be planted generally in the center of its surrounding soil area.

- j) The soil area around a street tree must be protected from compaction due to foot traffic. When the adjacent throughway is five (5) feet or wider, a tree guard (a metal fence at least 18 inches tall), must be installed around three sides of the tree (the curbside remains unfenced). When the adjacent throughway is less than five (5) feet wide, the soil area around a street tree must be protected by porous rubber tree pit surfacing. To prevent tripping hazards, the finished grade of the porous rubber tree pit surfacing must be level with the grade of the surrounding pavement.
- k) A gap of approximately eight (8) inches must be left between any mulch or porous rubber tree pit surfacing and the trunk of the tree to avoid mounding above the trunk flare.
- l) When planted, street trees must be a minimum height of ten (10) feet and/or two and one half (2.5) inches in caliper.

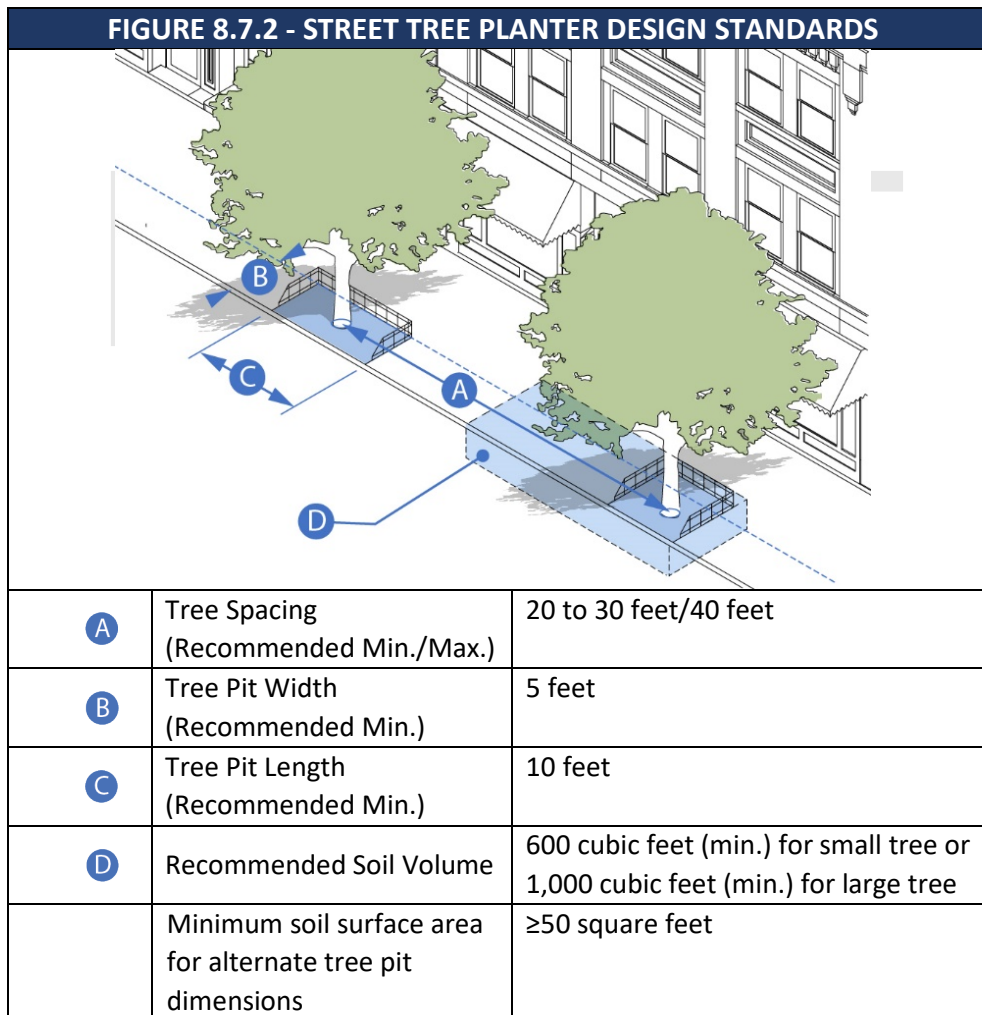

2. Recommended Techniques for Achieving Adequate Soil Volume. Urban soils beneath sidewalks are often compacted and deprived of water and nutrients, significantly compromising tree health, stability, and lifespan. When those conditions exist, the following techniques are strongly encouraged:
- The use of a modular suspended paving system, like Silva Cells, beneath the surrounding concrete sidewalk. The structural units in these systems are designed to bear the load of the concrete surface above, while providing void space which is filled with planting soil. Besides offering an environment for a tree's roots to grow, the more loosely compacted soil in these systems also offers bioretention of stormwater, which enters the system through permeable paving or through the tree pit.
 - Adjacent tree pits' soil volumes should be connected as a continuous trench, paved with permeable pavers or porous rubber surfacing.
 - Structural soil is not a substitute for modular suspended paving systems. The space for planting soil within structural soil is limited to the void spaces among the aggregate (only about 20% total). This is significantly less than the soil volume in a modular suspended paving system. Therefore, structural soil, while less expensive per cubic foot, ultimately restricts tree growth and health compared to a modular suspended paving system and so it should only be used as a supplement (around the backs and edges).

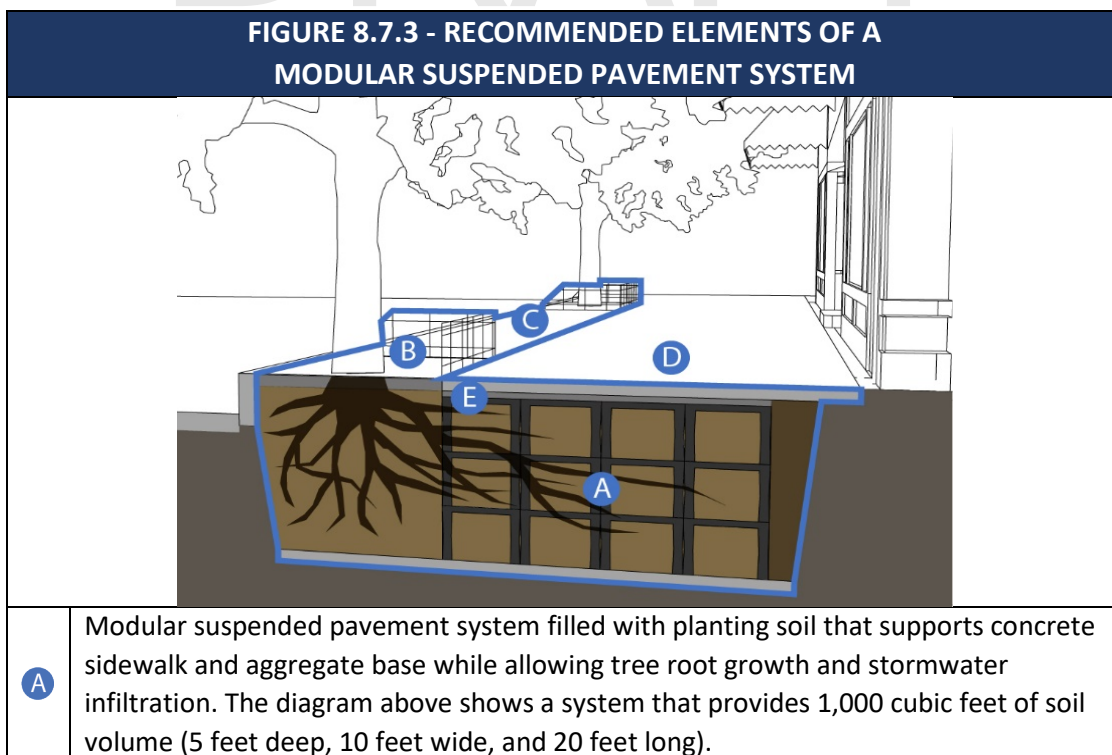

B	Soil pit protected by tree guard fencing or permeable rubber mulch walking surface.
C	Permeable paving strip, over modular suspended pavement system
D	Concrete sidewalk and aggregate base
E	Edge restraint between aggregate base and tree pit opening

E. Public Seating. (Also applies to Street Enhancement Zone, Furnishing & Utility Zone, Public Frontage Zone, and Building Frontage Zone).

1. Public seating is an essential component of Winchendon's public realm. It should be provided whenever possible. Public seating can take a variety of shapes including chairs, benches, seating walls, or low tables.



2. Any seating within the Street Enhancement Zone (e.g. in a curb extension), the Furnishing & Utility Zone, or the Public Frontage Zone will be considered public seating. Public seating must be available for public use and must comply with the standards in this section.
3. Providing public access to seating in the Building Frontage Zone is encouraged. Seating in the Building Frontage Zone must comply with the standards in this section.
4. Public seating must be sited according to the following design standards:
 - a) Public seating must not be placed where it would narrow the Pedestrian Throughway below the required minimum width;
 - b) Public seating must not be placed where it would obstruct access to a building entrance or exit;
 - c) Public seating must not be placed where it would obstruct access to bicycle parking, informational kiosks, fire hydrants, trash receptacles, or other street furniture;
 - d) Public seating must be permanently affixed to the ground. Moveable furniture may be acceptable within the public realm if a responsible party agrees to maintain the

moveable furniture in good working order, remove it at night and during snow emergencies, and replace it as necessary.

e) The following ADA clear widths must be maintained when installing public seating:

- 1) Three (3) feet minimum on either side of the seating;
- 2) Five (5) feet minimum from fire hydrants; and
- 3) One (1) foot minimum from any other amenity, utility, or fixture.

5. Public seating should be sited according to the following design guidelines:

- a) Site benches to provide views, preferably of people walking by;
- b) Provide seating in a variety of micro-climates. Locate some seating where there is summer shade, preferably from street trees. Locate other seating where it will be warmed by winter sun, especially adjacent to surfaces that will hold that heat, like stone or brick walls;
- c) Maintain adequately spaced pathways from parked cars and loading zones.
- d) Where possible, provide one (1) foot between the front of the bench and any Throughway so that the legs of people sitting on the bench do not obstruct the Throughway;
- e) Where the back of the seat abuts a building, wall, or other obstruction, a 1 foot minimum clear width should be provided for maintenance and trash removal.

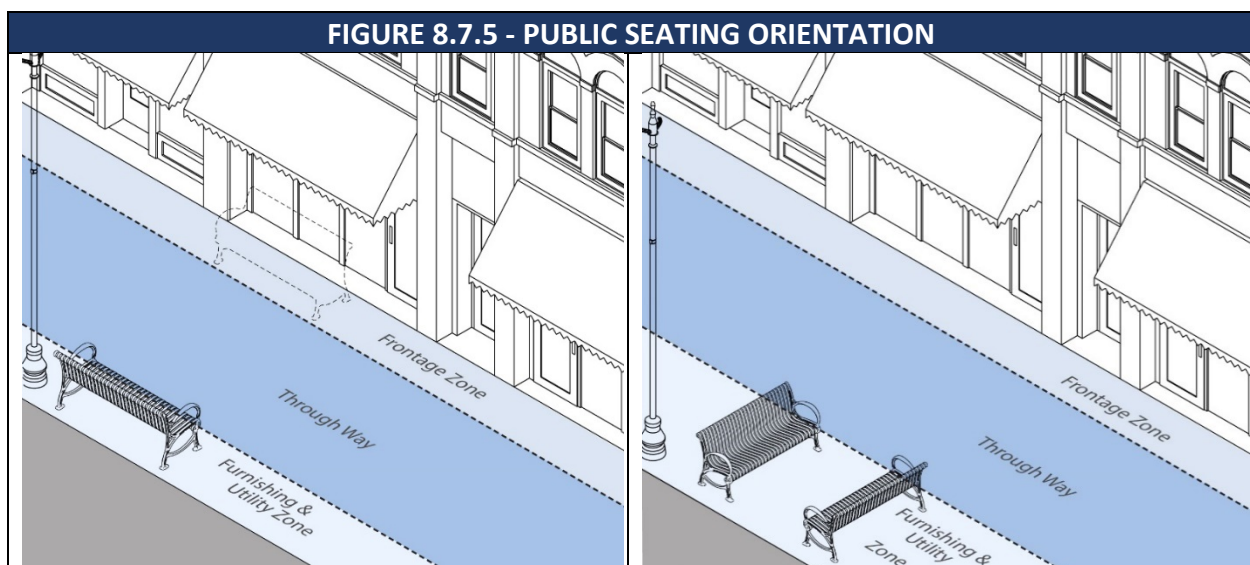

6. Public seating should generally be oriented so that it faces the nearest Throughway zone. When two or more seats will be arranged facing each other, the benches may be oriented

perpendicular to the Throughway Zone. When public seating is adjacent to a bus stop, it should face the bus stop, and be located to the right of the front door loading zone.

7. Seating should be provided both with and without armrests if possible. Armrests provide stability for those who require assistance sitting and standing. Seating without armrests allows a person in a wheelchair to maneuver adjacent to seating or to slide onto it easily. Seating areas longer than 4 feet should provide armrests or other dividers to discourage reclining.

F. Bicycle Parking. (Also applies to Street Enhancement Zone, Furnishing & Utility Zone, Public Frontage Zone, and Building Frontage Zone).

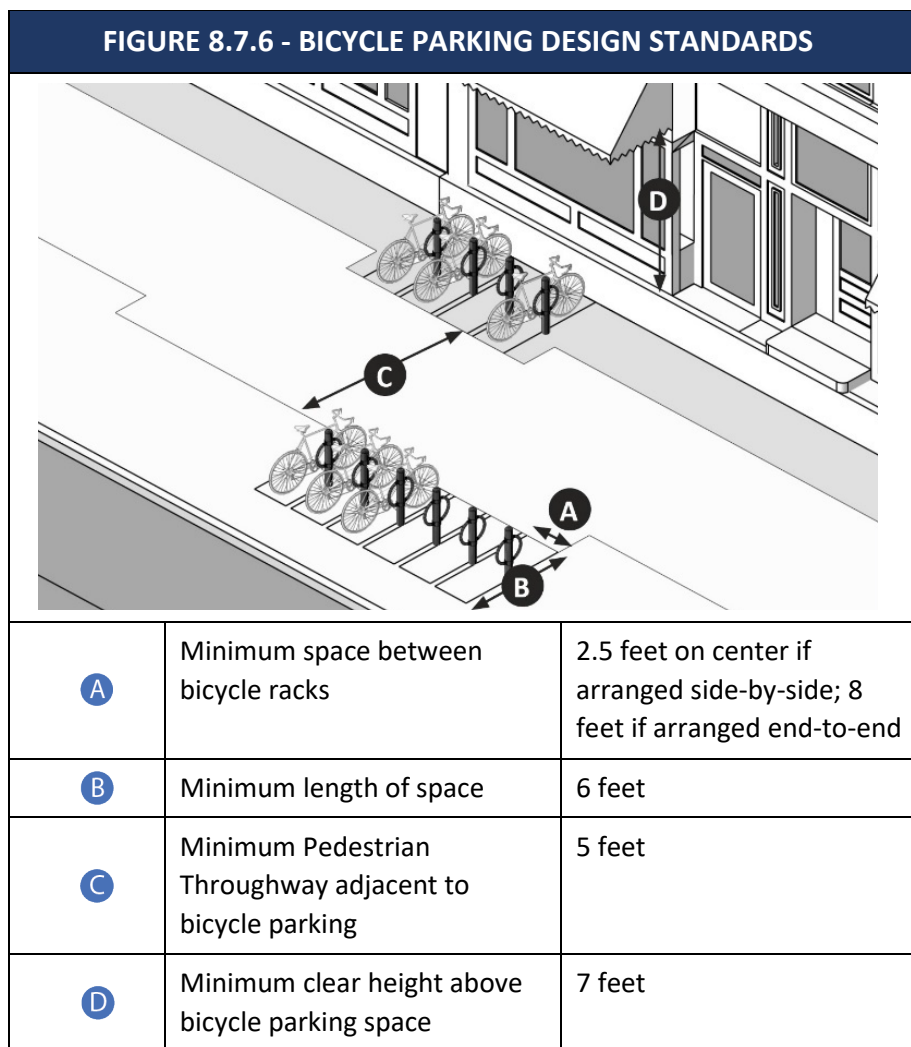

1. The following list sets out the Town’s preferred locations for bicycle parking from most preferred location to least preferred location: the Furnishing & Utility Zone, the Street

Enhancement Zone, the Public Frontage Zone, the Building Frontage Zone, beside a building, behind a building.

2. Installation of a bicycle rack within the public realm requires Town approval from the Board of Selectmen.

G. Driveway and Alley Crossings.

1. A driveway or alley that crosses a paved Furnishing & Utility Zone must be designed to maintain the grade and clear width of the adjacent Pedestrian Throughway and must include sloped flares on both sides of the driveway apron.
2. A driveway or alley that crosses a continuously planted Furnishing & Utility Zone must be designed to maintain the grade and clear width of the adjacent Pedestrian Throughway and must include returned curbs.

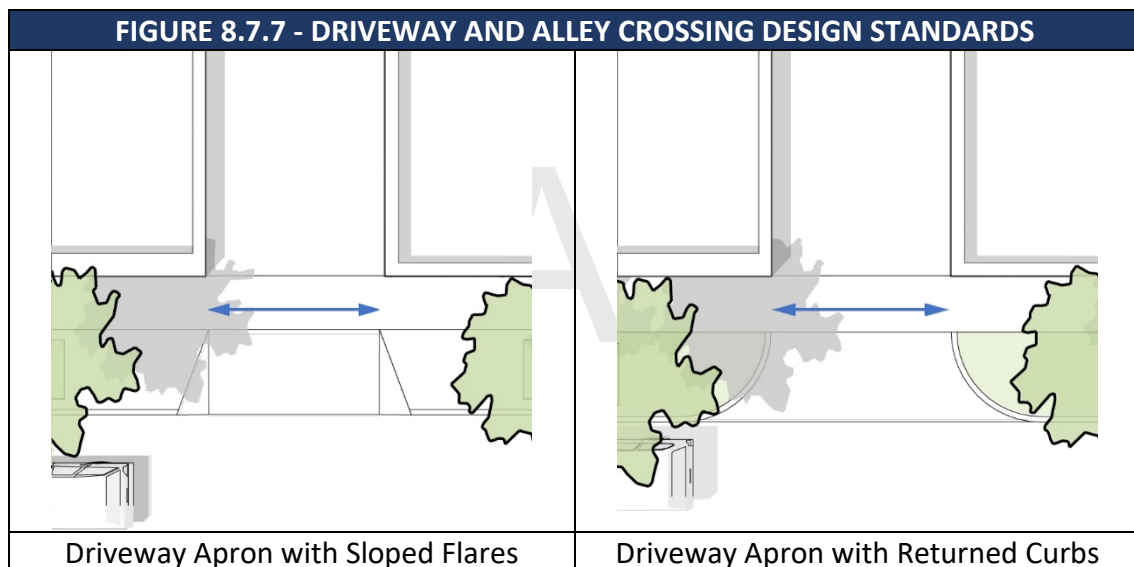

3. The appearance of any walkway (i.e. scoring pattern or special paving) must be maintained across any driveway or alley to indicate that, although a vehicle may cross, the area traversed by a vehicle remains part of the sidewalk.
4. A curb cut may be no wider than the driveway or vehicular entrance it serves, excluding flares or returned curbs. Additional curb cut standards may be established for individual zoning districts.
5. Shared driveways are permitted and encouraged.

8.8. PEDESTRIAN THROUGHWAY ZONE

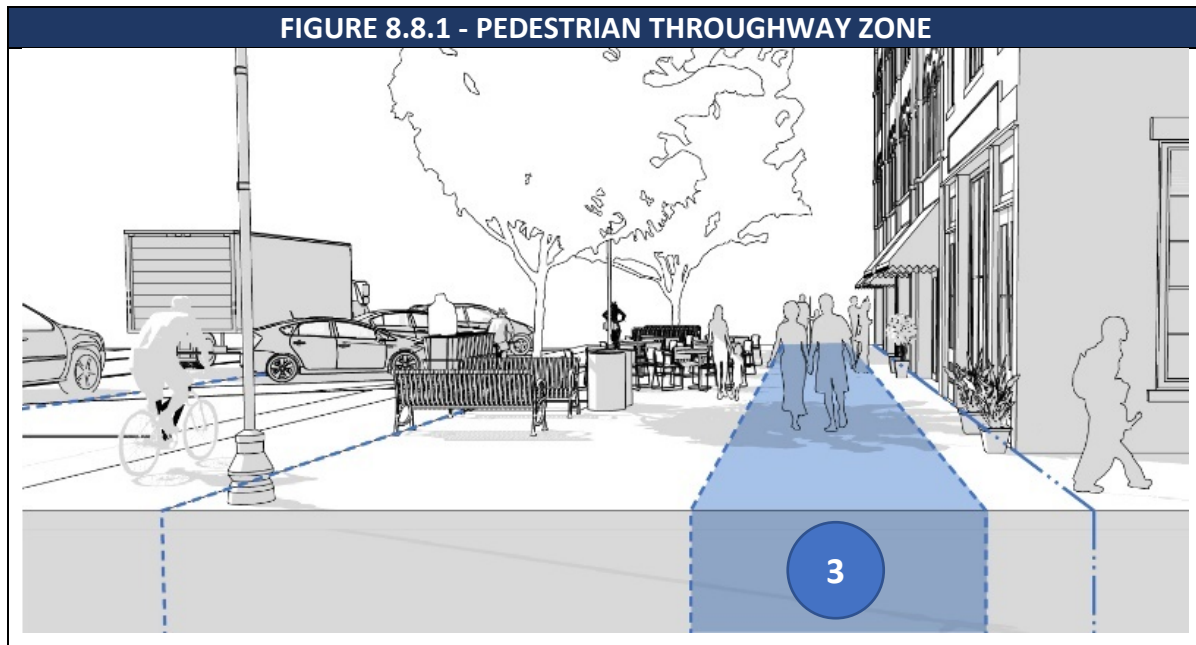

- A. Description.** The Pedestrian Throughway Zone is also known as the sidewalk. It is the primary portion of the sidewalk used for active movement and travel by pedestrians. The Pedestrian Throughway Zone must be an adequate width for comfortable two-way pedestrian movement, must remain clear of obstacles, and its paving surface must be relatively level.
- B. Width.** The required width of the Pedestrian Throughway Zone must be in accordance with the appropriate Street Type found in Section 8.4.
- C. Accessibility.** All new and reconstructed sidewalks must be accessible to and usable by persons with disabilities in accordance with the Americans with Disabilities Act and the Rules and Regulations of the Massachusetts Access Board (521 CMR), as amended.
- D. Construction.** Pedestrian Throughways (sidewalks) must be constructed of cement concrete that is 4 inches deep. Where a driveway crosses a sidewalk, the sidewalk's cement concrete must be 6 inches deep.
- E. Pavement.** The pavement design of Pedestrian Throughways must be continuous for the full length of each block face.

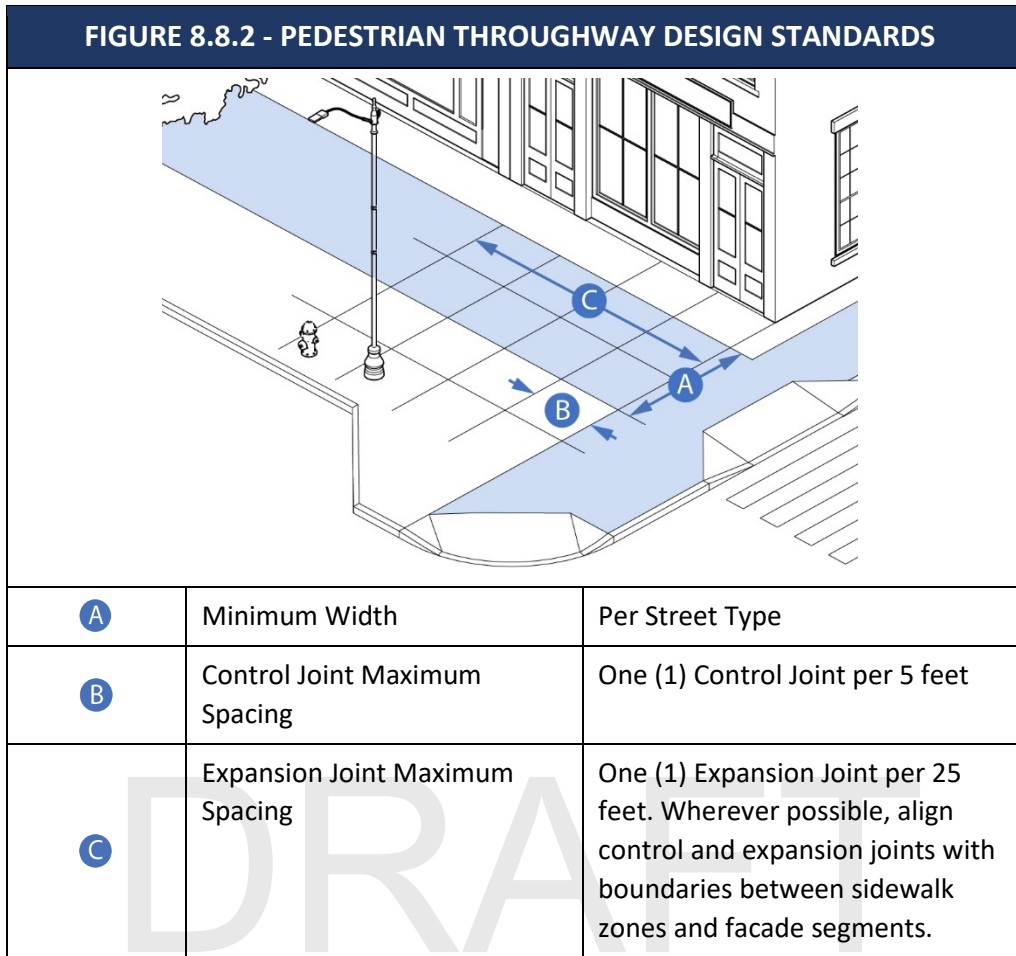

8.9. PUBLIC FRONTAGE ZONE

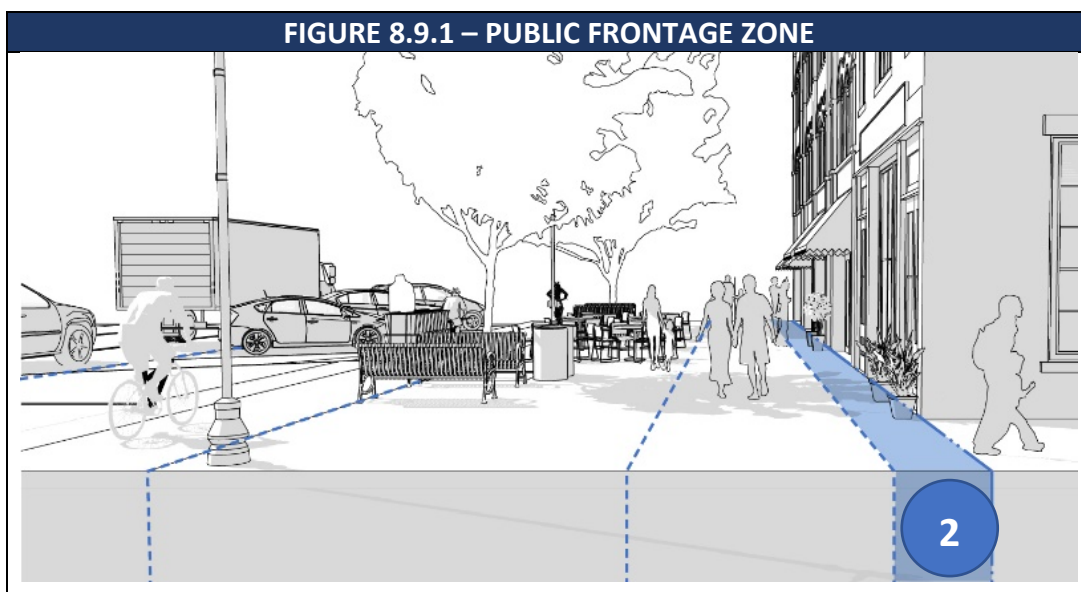

- A. Description.** The Public Frontage Zone is the area between the Pedestrian Throughway and the front lot line. The size and character of the Public Frontage Zone varies widely depending on context. On narrow streets, the Public Frontage Zone may be absent. On wide streets, the Public Frontage Zone provides a transitional space for people who are entering or exiting a building or pausing to read a menu or peer through a shop window. The materials and design of the Public Frontage Zone is often indistinguishable from the Pedestrian Throughway or the Lot Frontage Zone. The zones differ in their functions and the public realm components they can accommodate.
- B. Utilization of the Public Frontage Zone.** See Section 9.0 - Public Realm Activation

DRAFT

9.0 PUBLIC REALM ACTIVATION

9.1. INTENT

The intent of this section is to ensure pedestrian safety and comfort, promote economic vitality, preserve and enhance the character of the public realm along public streets, facilitate social activity and health benefits by providing walkable centers, neighborhoods and districts. The intent to facilitate a variety of activation forms to fulfill the potential of the “Outdoor Room” along Winchendon’s commercial and mixed use corridors.

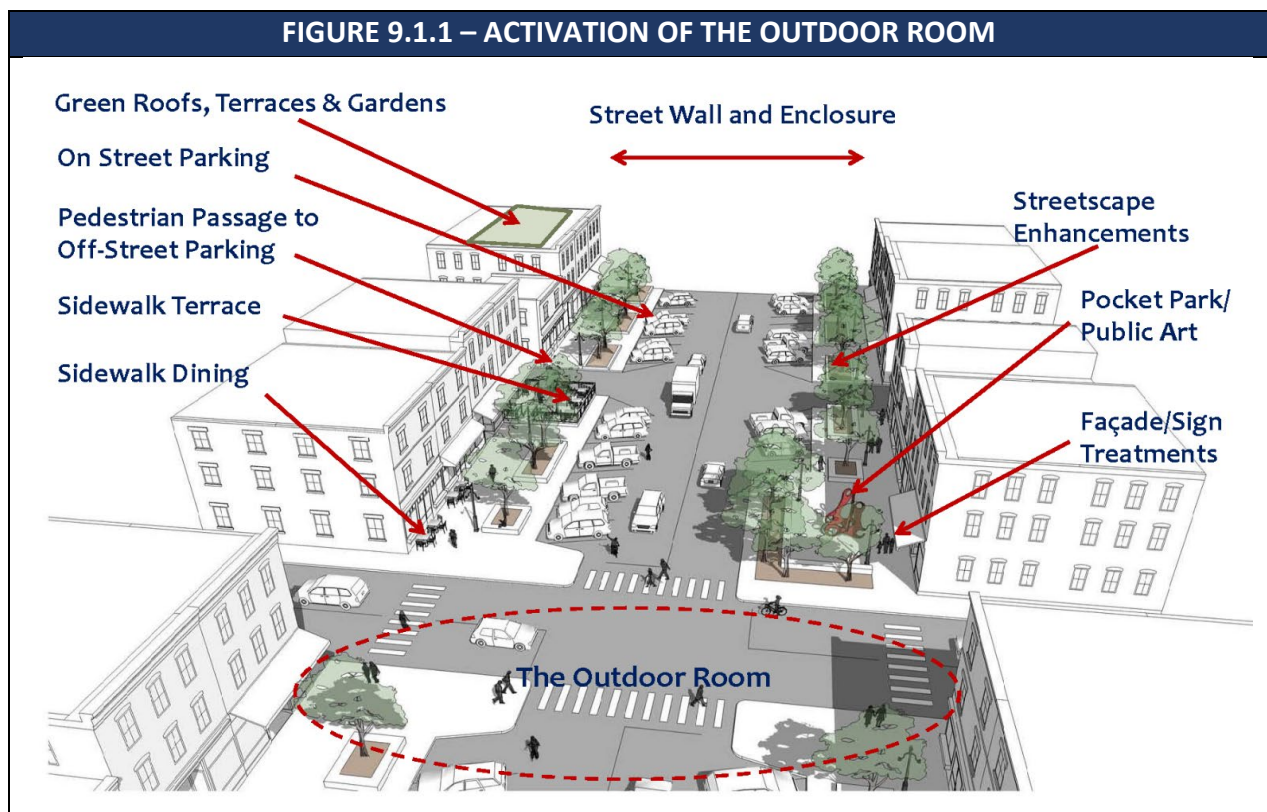

9.2. APPLICATION

- A. Public Realm Activation Components.** The allowed type and location of public realm activation components are listed in Figure 9.2.1 below.
- B. Activation Permits.** Activation permits may be approved by the Board of Selectmen for activation of a public street right of way under the allowed applications in this section. Applicants may include business owners with storefronts along the public right-of-way (with permission from the property owners), or operators of food trucks, pop-up stores, or similar types of activation.

FIGURE 9.2.1 - PUBLIC REALM ACTIVATION COMPONENTS



ACTIVATION COMPONENT	C. Vehicle Throughway Zone	5. Street Enhancement Zone	4. Furnishing and Utility Zone	3. Pedestrian Throughway Zone	2. Public Frontage Zone	1. Building Lot Frontage Zone (See Public Realm Stds)
Parklets		●				
Tactical Urbanism	●	●	●	●	●	●
Landmarks and Public Art		●	●		●	●
Café Seating			●		●	●
Storefront Displays and Chef Stations					●	●
Building Frontage Treatments						●
Building Facade Treatments						●
Building Encroachments						●

9.3. PUBLIC FRONTAGE ZONE

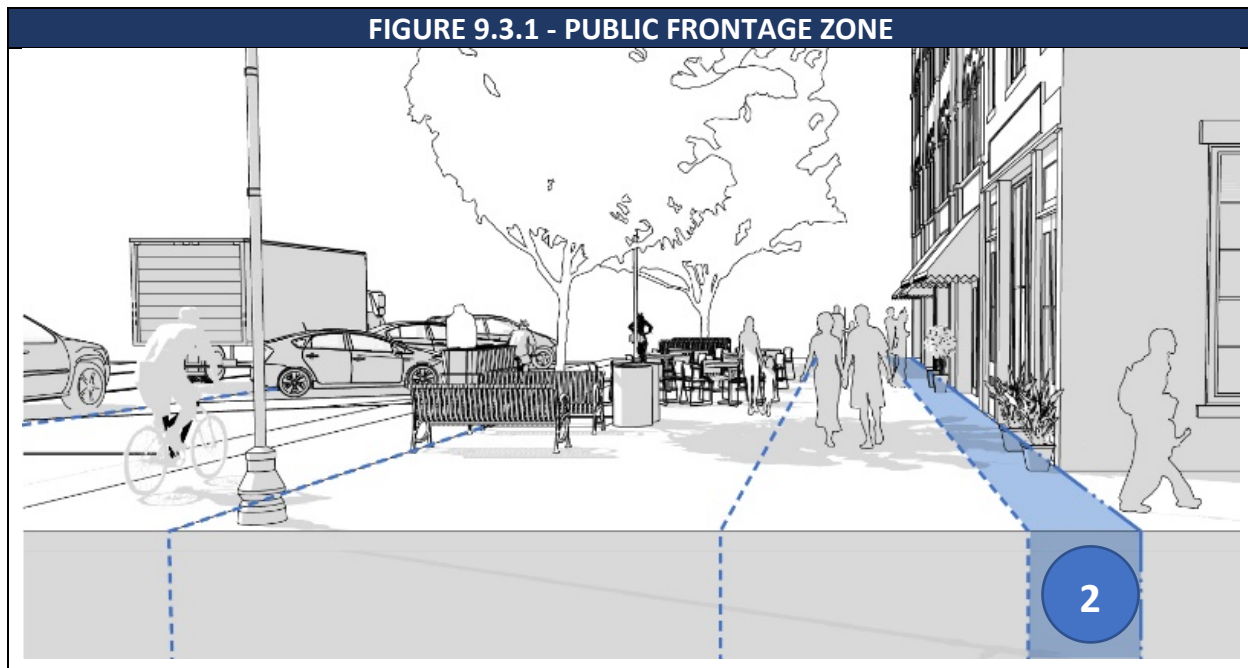

A. Description. The Public Frontage Zone is the area between the Pedestrian Throughway and the front building lot line. The size and character of the Public Frontage Zone varies widely depending on context. On narrow streets, the Public Frontage Zone may be absent. On wide streets, the Public Frontage Zone provides a transitional space for people who are entering or exiting a building or pausing to read a menu or peer through a shop window. The materials and design of the Public Frontage Zone is often indistinguishable from the Pedestrian Throughway or the Building Frontage Zone. The zones differ in their functions and the public realm components they can accommodate.

B. General Standards.

1. **Width.** The required width of the Public Frontage Zone must be in accordance with the appropriate Street Type found in Section 8.0 – Complete Streets.
2. **Materials and Construction.** Unless otherwise specified by the Department of Public Works, the materials and construction of the Public Frontage Zone should match, and be indistinguishable from, the Pedestrian Throughway.
3. **Other Standards.** Unless otherwise specified by standards provided by the Department of Public Works.

C. Outdoor Café Seating. (Also applies to Street Enhancement Zone, Furnishing & Utility Zone and Building Frontage Zone)

1. General Requirements.

- a) Outdoor cafe seating is permitted as an ancillary activity of any Eating & Drinking Establishment.
- b) The operator of the outdoor cafe seating is responsible for the proper maintenance of the cafe area at all times, including proper disposal of all trash generated.
- c) Outdoor Seating may be located in the Building Frontage Zone, Public Frontage Zone, Furnishing & Utility Zone, or Street Enhancement Zone
- d) Outdoor café seating within the Public Realm must receive an **Encroachment Permit** from the Board of Selectmen.
- e) Outdoor café seating must be located within the street frontage of the establishment it serves, and/or to the side or rear of the establishment it serves.

2. Design Standards for Outdoor Café Seating.

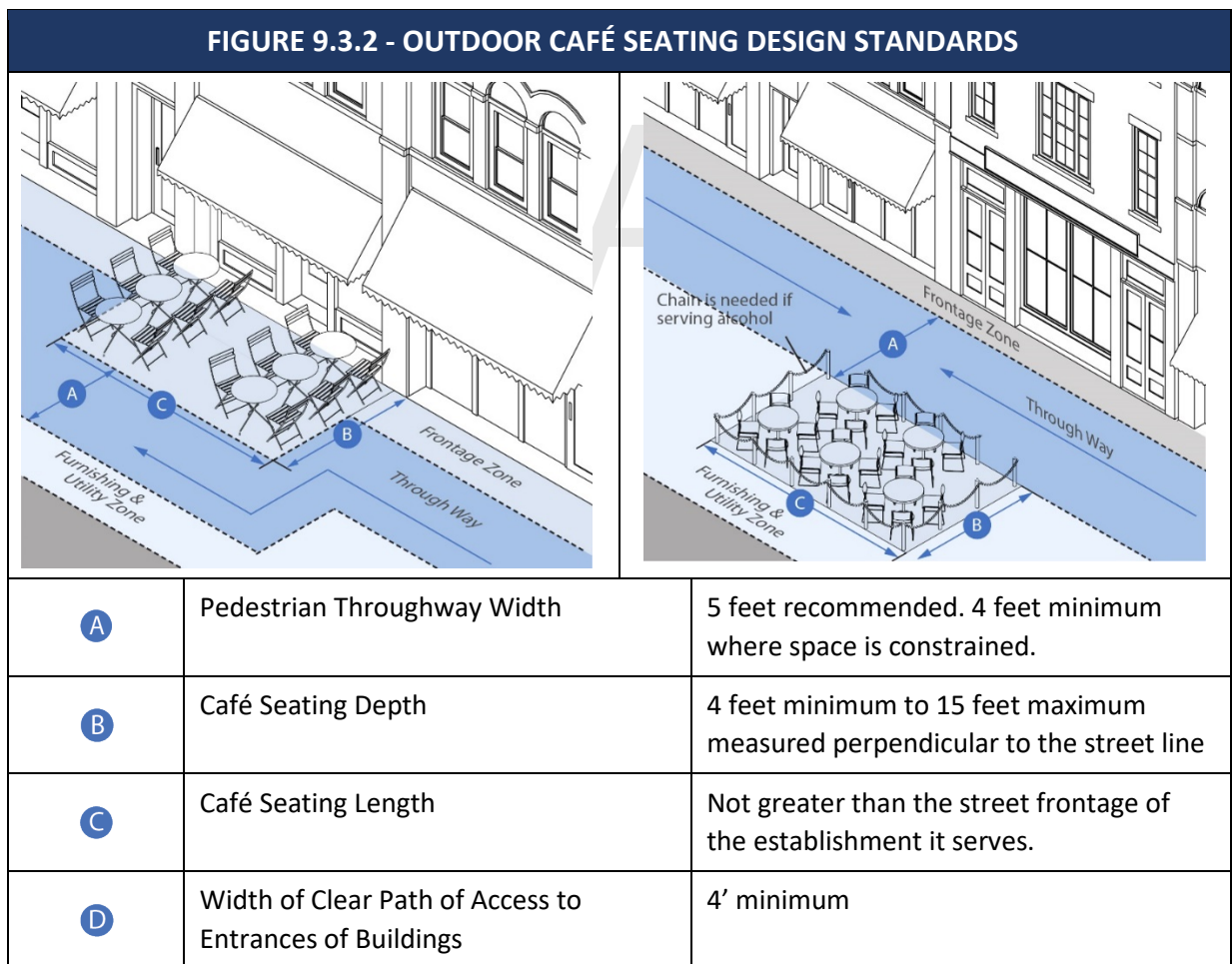

3. Furniture.

- a) Furnishings may only consist of moveable tables, moveable chairs, moveable umbrellas, required enclosures, and portable or mounted heaters.
- b) All furnishing must be commercial grade and manufactured for outdoor use of safe, sturdy, and durable materials, such as wood, steel, or wrought iron.
- c) When not intended for use during the winter months, outdoor cafe furnishings must be removed and stored indoors.
- d) Tables and chairs for each establishment must match in material and style.
- e) Tables larger than three (3) feet six (6) inches in width or diameter are not permitted.
- f) Standing or stooled table ledges, if provided, must be eighteen (18) inches in depth.
- g) Heaters are encouraged to extend the use of outdoor cafe seating during colder weather. The following standards apply:
 - 1) Heating fixtures require approval by the Fire Department.
 - 2) Heaters may be freestanding or mounted to the underside of an awning.
 - 3) Portable heaters must be stored indoors when the business is closed.
- h) Host stands should complement the chairs and tables in material and style.

4. Weather Protection.

- a) Awnings or individual table umbrellas are encouraged to provide protection from the weather.
- b) Awnings must be secured to a storefront or other exterior wall of a building.
- c) Awnings and umbrellas should be canvas or other non-vinyl material.
- d) Awnings and umbrellas should provide shade for at least fifty percent (50%) of the outdoor cafe seating when provided.

5. Waivers. When outdoor café seating is located to the side of or behind the establishment it serves, the Planning Board may waive requirements of this section.



D. Outdoor Retail Displays.

1. Purpose. Outdoor retail displays located within the public realm can increase the visibility and viability of businesses and can enhance the walkability of an area.
2. Standards. The placement for display and sale of merchandise within the Lot Frontage Area or the Public Frontage Area adjacent to a retail business may be allowed without an Encroachment Permit under the following standards:
 - a) An outdoor retail display is prohibited at any time the use of the associated establishment is not open for business and is prohibited between the hours of 11 p.m. and 7 a.m..
 - b) An outdoor retail display may not obstruct pedestrian or vehicular traffic or be in located in a required corner visibility triangle.
 - c) An outdoor retail display must be located at least two (2) feet outside of the required width of a Pedestrian Throughway Zone.

- d) Unobstructed passage must be provided to building entrances. The passage must be 4' wide minimum with an additional 2' buffer where an outdoor retail display abuts the passage.
- e) Outdoor retail displays must be located at least 2' from any fire hydrant, street furnishing, street tree, or other fixture, and must not infringe upon any area required for the operation of bicycle parking;
- f) Furniture and equipment must not be anchored to a ground surface within the right-of-way nor be attached or affixed to any tree, post, sign or other structure;
- g) A sidewalk retail display area must not exceed 100 square feet for all outdoor displays areas associated with a use; and
- h) Merchandise and display fixtures must not exceed five (5) feet in height and four (4) feet in depth (measured perpendicular to the street line).

FIGURE 9.3.4 – OUTDOOR RETAIL DISPLAYS



E. Storefront Window Displays and Signage. Storefront display windows that display products or services, signs with the name of the business, logos, hours, public service messages or displays, or views to an activity in which people are involved frequently during hours of operation are encouraged. General storefront window display guidelines are as follows:

1. Reflective or dark tinted glass, or reflective films should be avoided.
2. Incorporating a glazed transom above the door is encouraged when storefront heights are sufficient to allow for it.
3. Transparent storefronts are not necessary for some businesses, such as professional offices. Nevertheless, it is preferable to maintain substantial storefront glazing and provide attractive window treatments to avoid blank facades along the sidewalk.
4. Items should not be placed in storefront windows that block views to internal activity, such as the backs of display cases, unless they are part of a display to the outside sidewalk or street.
5. Storefront lighting should be confined to highlighting signage and the window display itself. Lighting that attracts attention to itself should be avoided.

9.4. STREET ENHANCEMENT ZONE

The Street Enhancement zone includes on-street parking and potential pedestrian activity areas between the Furnishing & Utility zone and the edge of street and bicycle travel lanes. Components in this area include temporary uses such as a food truck, which take over parking spaces, and permanent components like stormwater infiltration areas, bike racks and corrals, curb extensions, and crosswalks.

A. Parklets.

1. A parklet is a public space treatment where pedestrian-oriented amenities are placed within the street enhancement zone.
2. A parklet provides Outdoor Amenity Spaces to the general public or an adjacent building use. A parklet is typically installed where additional outdoor amenities are desirable to enhance the pedestrian environment, but sufficient space is not available within the Furnishing and Utility Zone, Public Frontage Zone or Lot Frontage Zone.
3. A parklet is typically installed where there is an on-street parking lane. A parklet may be installed where there is not an on-street parking lane at the discretion of the permit granting authority, provided the parklet will not cause a hazard to travel.

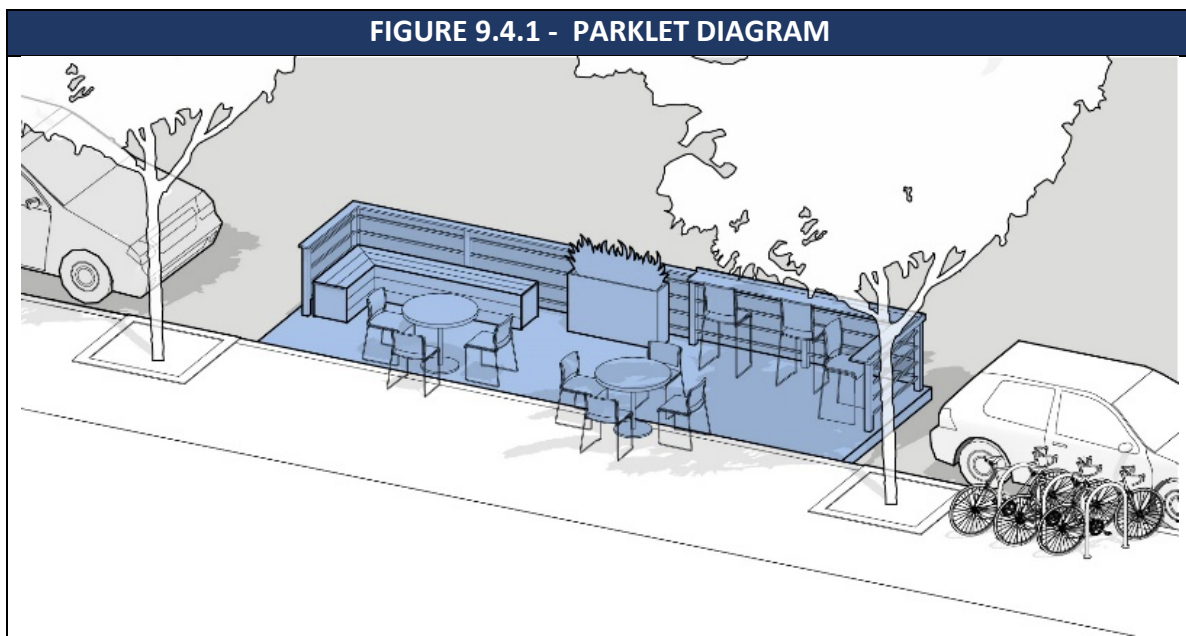

4. Design Standards.

- a) A parklet may be used for public pedestrian-oriented amenities including, but not limited to seating, bicycle parking, planters, or exercise stations.
- b) Use of a parklet for food service, a pop-up store or other temporary retail use may be allowed by site plan approval when it is located within the frontage of a similar adjacent permitted use.
- c) Use of a parklet for food service, a pop-up store or other retail use may be allowed by special permit when the use is not associated with an adjacent permitted use.
- d) A parklet must extend out from the sidewalk flush with the level of the curb.

- e) A parklet should be a minimum of 6 feet wide. It may occupy the full width of the parking lane it extends into or be set back from a motor vehicle lane or bicycle lane by a 1 foot buffer, at the discretion of the permit granting authority.
- f) A parklet must be setback at least fifty (50) feet from the corner of a street.
- g) A parklet must have a sufficient barrier at its street edge to ensure that pedestrians will not cross from the parklet into adjacent travel lanes.
- h) The Town may adopt specific design standards and guidelines for parklets.
- i) If a parklet is proposed as part of a project that otherwise requires a special permit or site plan approval, the parklet may be incorporated into that permit approval process.
- j) When a parklet does not require a special permit or site plan approval from the Planning Board, the parklet requires a blocking permit from the Department of Public Works, which requires approval from the Chief of Police and consultation with the Parking Enforcement Administrator. The standards contained within this section apply at the discretion of the Department of Public Works.

FIGURE 9.4.2 - ILLUSTRATIVE EXAMPLES OF PARKLETS

B. Tactical Urbanism.

1. Tactical Urbanism is the short-term (less than six months) installation of elements within the public realm that are intended to temporarily enliven the public realm, or to pilot test more permanent public realm improvements. Typical examples include temporary parklets, temporary installation of public seating, temporary curb extensions, temporary bicycle lanes, and chalk art.
2. Any allowed Public Realm Component may be tested via Tactical Urbanism with Planning Board approval. The Planning Board may waive any Public Realm Components standards that it deems are inappropriate or unnecessary for a short-term installation. Project proponents are responsible for obtaining any other permits that may apply to their project, for example, permits from the Department of Public Works, the Police Department, the Parking Enforcement Administrator, Board of Selectmen, or other boards as required.

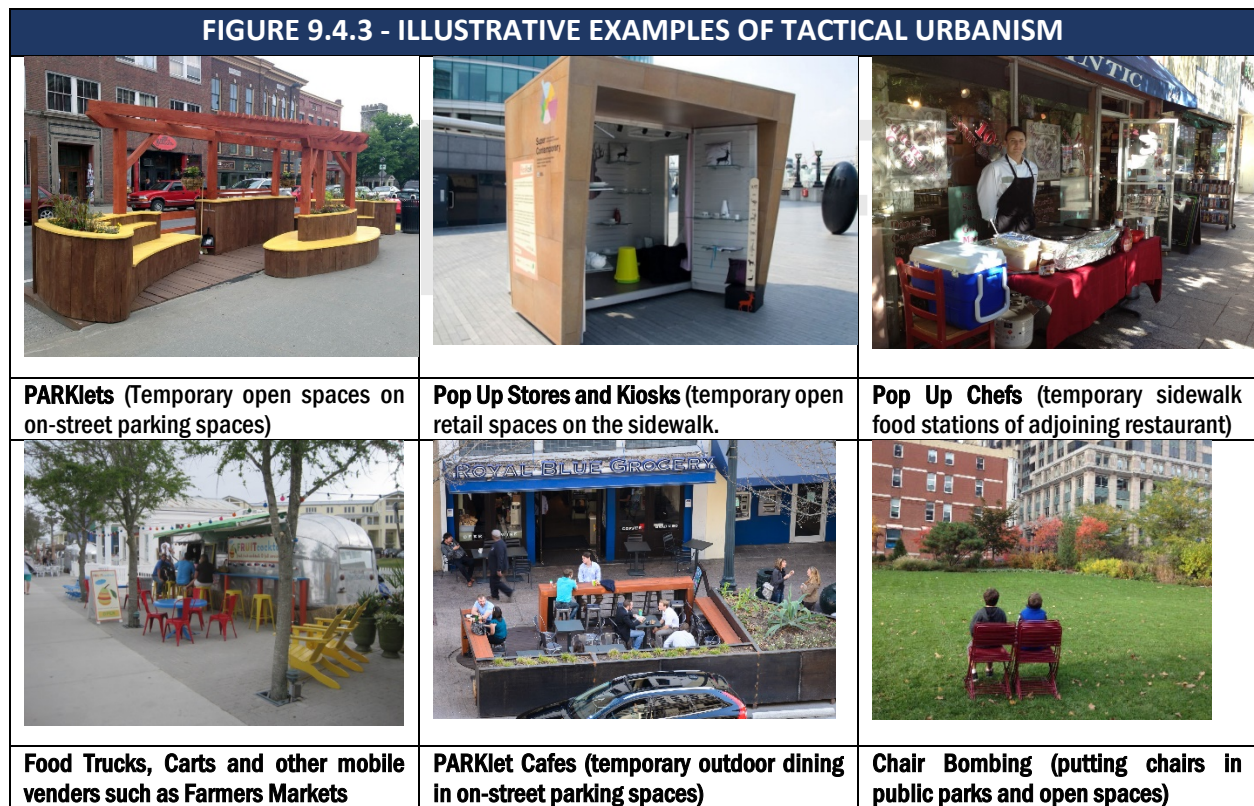

C. Street Banners. Pole mounted street banners and an attractive method of adding color to the public realm and celebrating the districts. Sometimes street banners are coupled with hanging flower baskets. Street banners over the street also add interest for pedestrians and travels. They announce an arrival into the district and provide information about community events.



D. Landmarks and Public Art.

1. Landmarks are designed to commemorate an important event or important person in the history of the Town. Public Art is an artistic expression designed for the enjoyment or education of the general public. Landmarks and Public Art may be freestanding or incorporated as a subordinate feature of any other Public Realm Component or Civic Space. Landmarks and public art installation can take many forms including stone or metal memorials and monuments, sculptures, fountains, plaques, signage, murals, or landscape designs. They should be designed as special features that bring people together and enliven the experience visitors in exploring Winchendon.
2. Standalone Landmarks and Public Art are allowed by-right subject to any other necessary permits.
3. When a long-term Landmark or Public Art installation is included in a project requiring a Special Permit or Site Plan Approval, the Planning Board has jurisdiction over its location, its impacts on other aspects of site design, and its off-site impacts. The Arts Council has jurisdiction over the public art itself.
4. Design standards are as follows:
 - a) The design, size, and placement should be compatible with and integrated with the site or public realm context.
 - b) Landmarks and Public Art must not interfere with the safe movement of pedestrians, bicyclists or motor vehicles
 - c) A three-dimensional Landmark or Public Art installation must be located:
 - 1) At least 7 feet above any area intended for pedestrian movement.
 - 2) 5 feet minimum from fire hydrants;

- 3) 1 foot minimum from any other amenity, utility, or fixture;
 - 4) 2 foot from any Pedestrian Throughway if people are expected to stop and look at the Landmark or Public Art.
 - 5) Where the back of the installation abuts a building, wall, or other obstruction, a 1foot minimum clear width should be provided for maintenance and trash removal.
- d) Landmarks and Public Art must be permanent fixtures and made of materials that will withstand all weather conditions and the test of time.
- e) Installations must be properly maintained.



- E. Art Murals.** A sign that is directly painted on to the exterior wall of a building or screen printed, sewn, or adhered onto a canvas-like material that is mounted flush with the facade of a building that identifies a commercial establishment. Wall murals are intended to be viewed by pedestrians and motor vehicles from a distance. Art murals should be no larger than 1,000 square feet with a maximum width of 75 feet and maximum height of 50 feet.

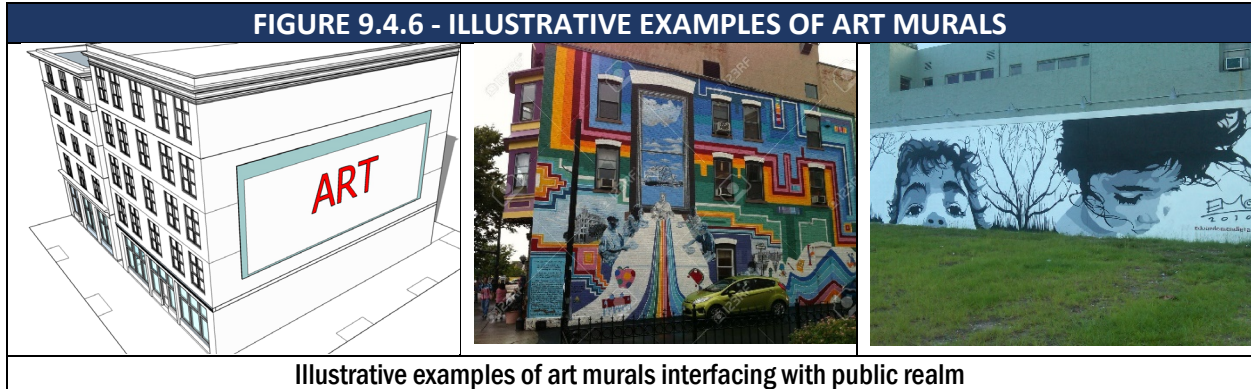

9.5. BUILDING FRONTAGE ZONE

A. Description. The Building Frontage Zone includes the front portion of a lot that abuts a public right-of-way. Though often private property, the Building Frontage Zone is a crucial part of the public realm. This area shapes the public realm (both horizontally and vertically), helps to define its character, and impacts how the public realm is perceived by people. Functionally, the Building Frontage area provides a transition between the public realm and the private realm. It accommodates semi-public or private outdoor spaces like plazas, seating terraces, and gardens or yards. It also accommodates transitional spaces between indoors and outdoors. The figure below illustrates two uses of the Building Frontage Zone. The top diagram shows a building built to the front lot line. The building occupies the Building Frontage Zone. The bottom diagram shows a building set back from the street line. An outdoor seating area and garden occupies the Building Frontage Zone which abuts the Pedestrian Thoroughway without an intervening Public Frontage Zone.

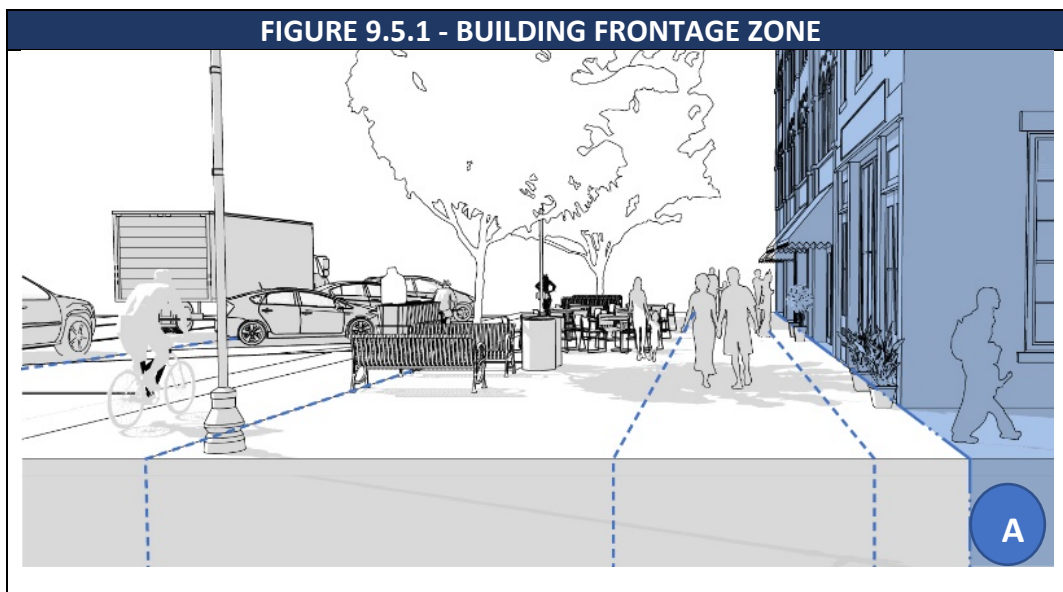

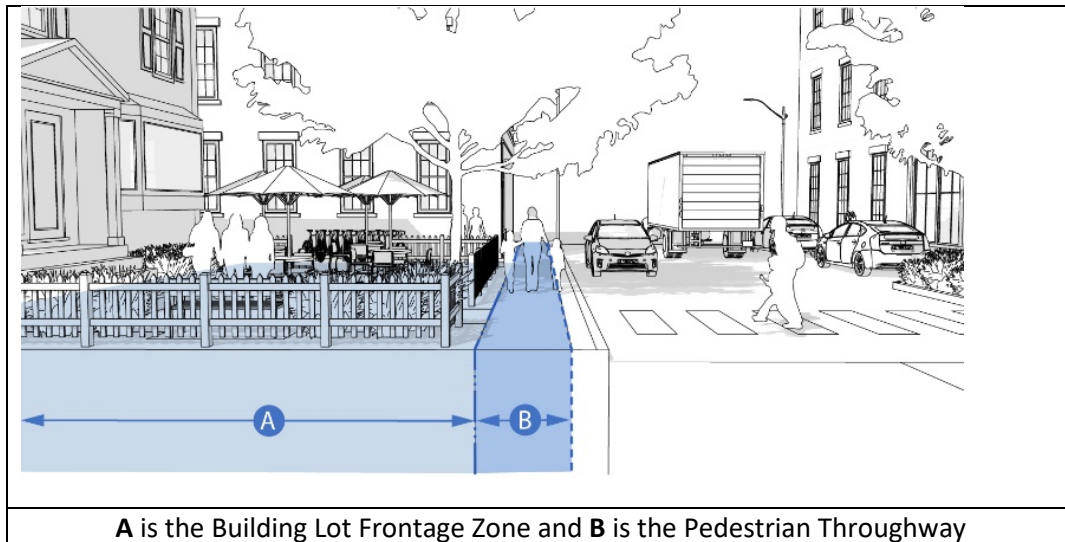

B. Building Frontage Zone Encroachments. Business and property owners are encouraged to collectively create a vibrant and engaging pedestrian environment in the **Planned Development Zoning District** through a series of permanent and temporary activation applications. These activities can take place in the private (building) frontage zone and public frontage zone. The Town may also play an active role in implementing these enhancements in collaboration with businesses and property owners. Frontage encroachments into the public right-of-way is only permitted where there is adequate width for the Pedestrian Throughway and require a permit from the Selectboard.

1. Café Seating/Dining Terrace. See Section 9.3.
2. Merchandise Display. See Section 9.3.
3. Ground Sign. See Section 6.0
4. Sandwich Board Signs. A freestanding portable sign, not secured or attached to the ground or any building or structure, composed of a sign panel and supporting structure or one or more panels which form both the structure and sign face, and which is intended to be placed in a sidewalk or pedestrian way. Sidewalk signs displayed on a public sidewalk should be within 3 feet of the building; are prohibited from interfering with pedestrian travel and must leave clear an accessible walkway area of 5 feet minimum; must be removed when the business is not open; and comply with all applicable town bylaws.

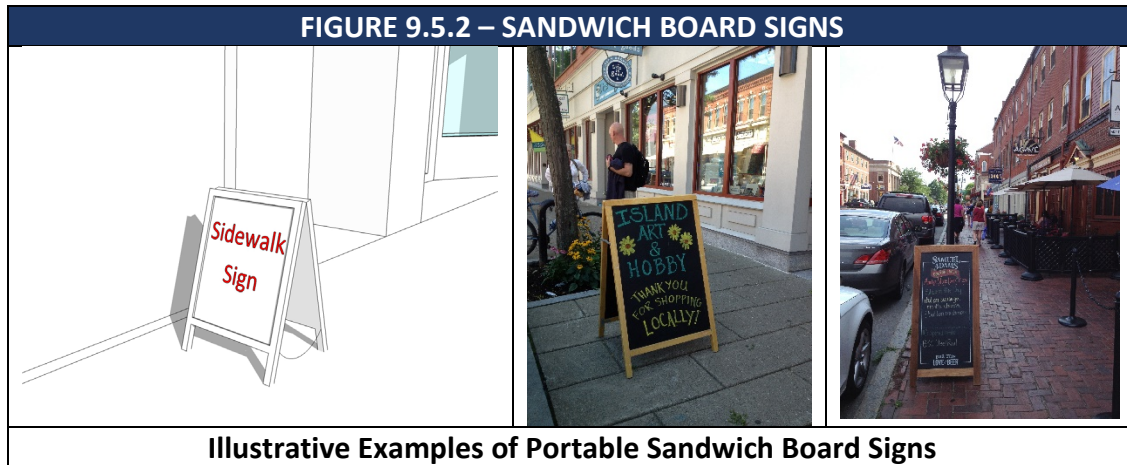

Illustrative Examples of Portable Sandwich Board Signs

C. Projecting Banners and Blade Signs. A building mounted sign attached to, and extending from, a building or support beam in whole or in part which extends beyond said building. Projecting signs may encroach into the public right-of-way but must be located back 5 feet to the closest curb line. Projecting sign should be mounted a minimum of 6 inches away from the building and 8 feet from the bottom of the sign to the sidewalk grade; and comply with all town bylaws.

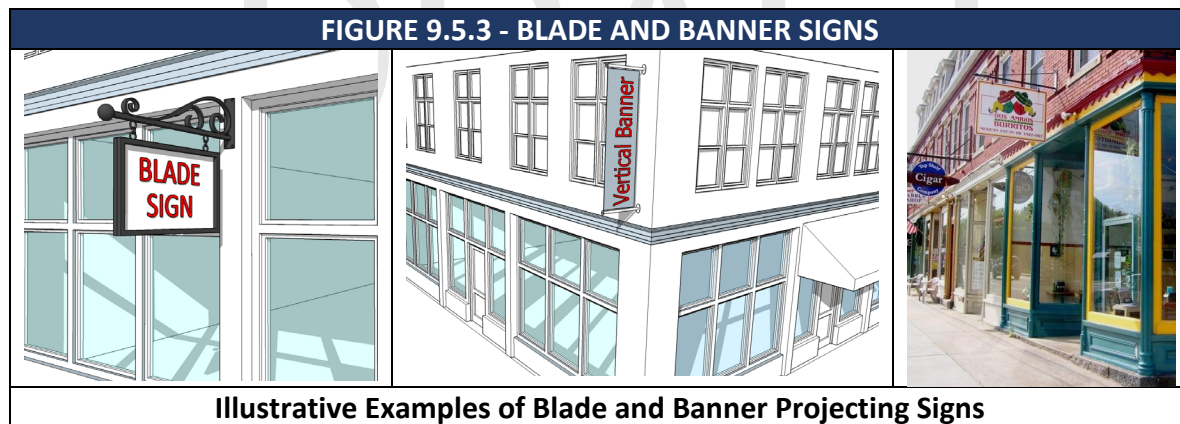

Illustrative Examples of Blade and Banner Projecting Signs

D. Marquee Signs. A sign painted on, attached to, or supported by a marquee—a permanent roof-like shelter, either open or covered, extending from part or all of a building face and constructed of some durable material which may or may not project over a public right-of-way. Marquee signs should provide a minimum of 10 feet of clearance above grade and project no more than 10 feet from the building but not closer than 3 feet from the curb line.

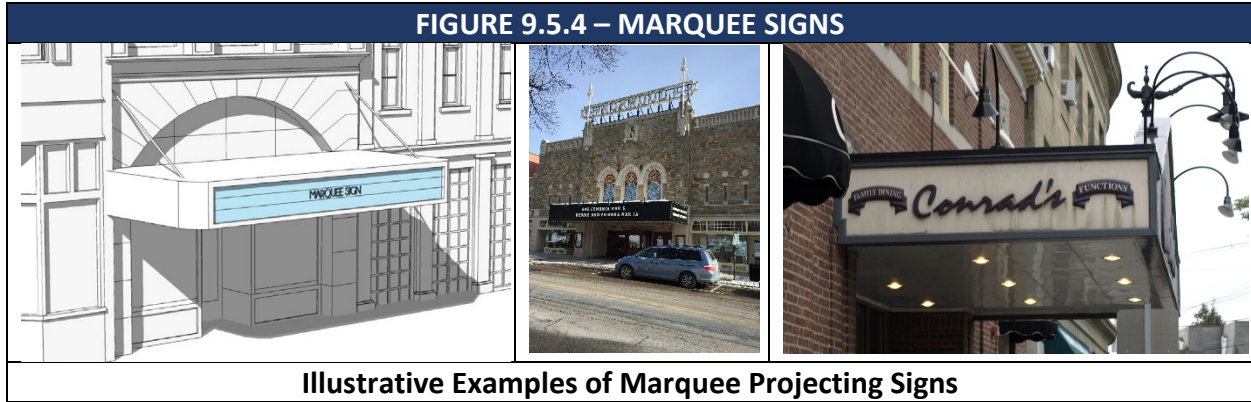

E. Storefront Awning. An awning projecting over a private frontage zone or the sidewalk should have 8 feet of clearance in height, 8 feet in clearance from the curbline, and comply with all applicable town bylaws.



F. Balcony. A balcony projecting over a private frontage zone or public sidewalk should have 12 feet of height clearance, 8 feet in clearance from the curbline, and comply with all applicable town bylaws.

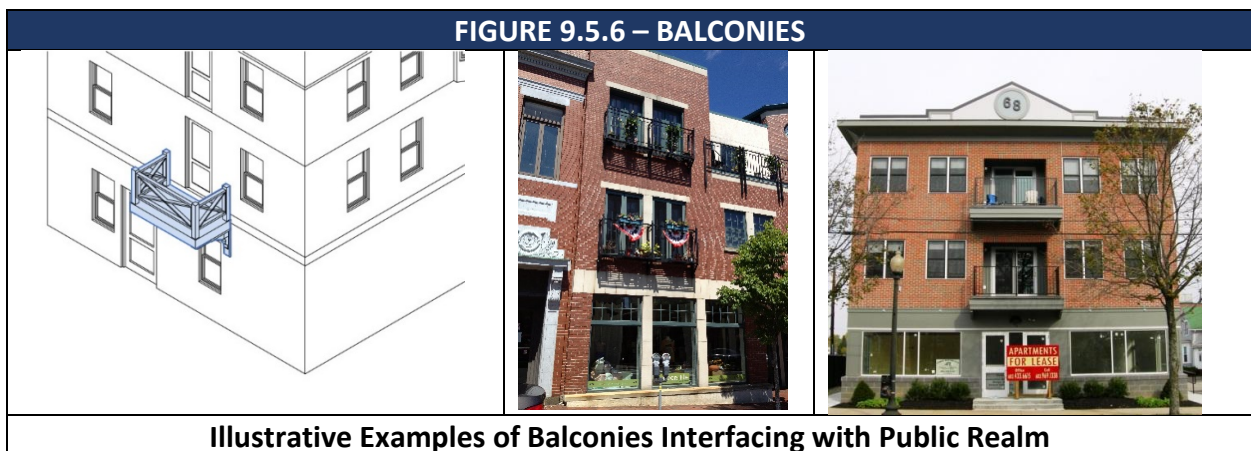

G. Bay Windows. Bay windows projecting over a private frontage zone or public sidewalk should have 12 feet of height clearance, 8 feet in clearance from the curblineline, and comply with all applicable town bylaws.

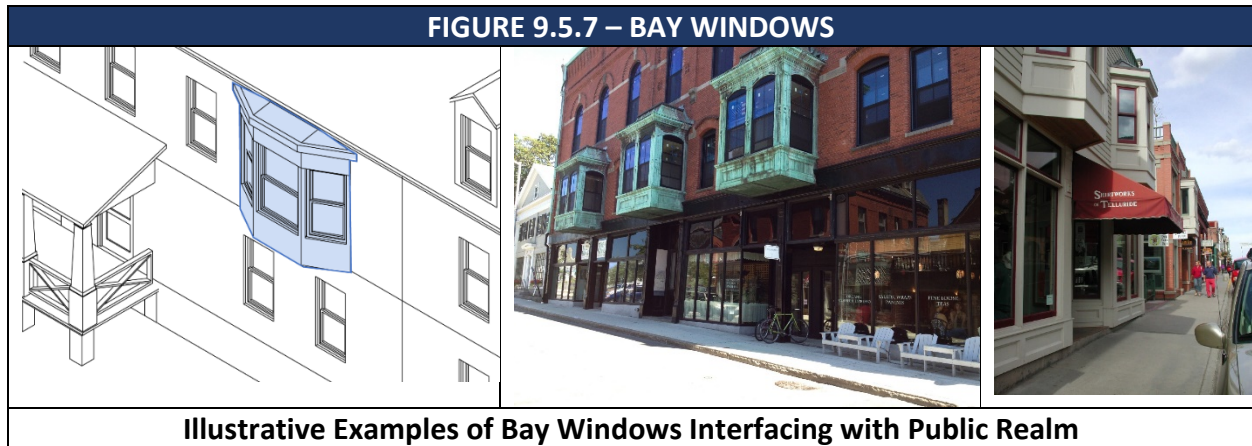

H. Arcade. A building frontage where only the ground floor level of the building facade is set back from the street row line. The building facade for the upper floors is at the street row line and is supported by a colonnade with habitable space above. The arcade is intended for buildings with ground floor commercial, hospitality or retail uses. See arcade design standards in Section XX.

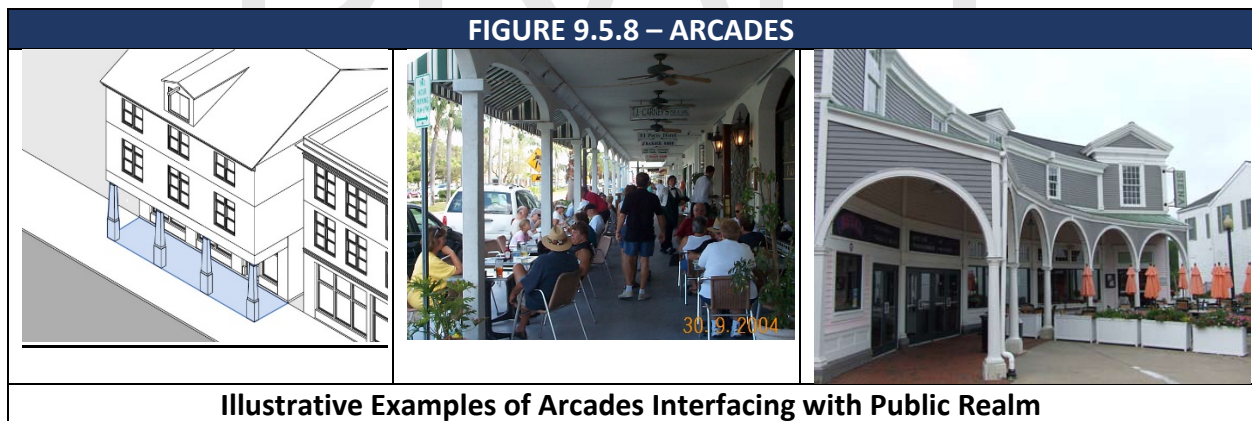

I. Gallery. A building frontage where the facade is set back from the street row line with an attached one or two story cantilevered balcony or colonnade that is built to the street row line. A gallery is intended for buildings with ground floor commercial, hospitality or retail uses. A gallery may project over a public sidewalk with Town approval. See design standards for a gallery in Section XX.

FIGURE 9.5.9 – GALLERIES



Illustrative Examples of Galleries Interfacing with Public Realm

DRAFT

10.0 GLOSSARY OF TERMS

This Glossary has been prepared to explain terms used in the *Sustainable Development Standards* that may be technical in nature or specific to Winchendon. Other terms and definitions are part of the *Zoning Bylaw*.

Applicant – The person or entity having the legal authority and who is seeking a permit or approval from the Town of Winchendon to construct or use property subject to the provisions of this *Zoning Bylaw*, or the authorized agent of any such person or entity.

Awning – A sheltering or covered frame, often of fabric, either stationary or on a retractable system attached to a structure. The awning does not receive stanchion support as in a canopy.

Awning or Canopy Sign – A sign painted, stamped, perforated, stitched, or otherwise applied on an awning, canopy or marquee, including backlit signs.

Buffer – Landscape or fencing that is used to screen and/or mitigate the impacts of utilitarian elements of a building or site, such as dumpsters, loading areas, or mechanical equipment.

Buffer Zone – Land which is maintained in either a natural or landscaped state, and is used to screen and/or mitigate the impacts of development on surrounding areas, properties or rights-of-way.

Building – An independent structure having a roof supported by columns or walls resting on its own foundations and designed for the shelter, housing, or enclosure of persons, animals, chattels, or property of any kind.

Building Height – The vertical distance from grade to the top of the highest point of the roof or structure.

Business – Any lawful commercial endeavor to engage in the purchase, sale, lease, exchange or provision of goods and for the provision of services or instruction.

Canopy – A sheltering or covered frame, often of fabric, which is attached to a structure at the inner end and receiving stanchion support at the outer end.

Common Driveway – A privately owned driveway, paved or not, providing vehicular access between two or more buildings and a street. A common driveway does not serve as legal frontage for a lot.

Compatible – A visual and aesthetic consideration that allows two parts to exist or occur together without conflict or diminishment of the other part.

Dark-Sky – An international initiative, embraced by the Winchendon Zoning Bylaw, to reduce light pollution intending to increase the number of stars visible at night, reduce the effects of

unnatural lighting on the environment and cut down on energy usage. The dark-sky movement encourages the use of full-cutoff light fixtures that cast little or no light upward in public areas.

Development Review Committee (DRC) – A committee representing staff from the Building Department, Conservation, Economic Development, Engineering, Environmental Fire Department, Services, Land Use, Health, and Development, Planning, Police, Department of Public Works, Town Manager, and Zoning to assist and advise the Planning Board and its applicants with regard to the site plan review and sustainable development.

Dormer – A roof-covered projection from a sloped roof. A window set in a small gable projecting from a roof.

Eave – The projecting lower edges of a roof overhanging the walls of a building.

Entablature - The upper panel of moldings and bands which lie horizontally above columns. Entablatures are important elements of classical architecture. They are a common area to provide the most prominent signage for a building.

Establishment – A separate and distinct use, business, enterprise, institution, or organization occupying space within a building.

Façade – The substantially vertical exterior surface of a building or structure exposed to public view.

Fence – Any artificially constructed barrier of any material or combination of materials used as a boundary, or erected to prevent intrusion, or to enclose, buffer or screen areas of land.

Frontage – That portion of a lot which fronts on a street or streets from which physical access to the principal building on the lot can be provided. Frontage is measured as the distance between the points of intersection of the side lot lines with the front lot line. In the case of a corner lot bounding more than one street, the measurement on both streets may be used to determine if the lot meets the minimum frontage requirements of the particular zoning district. With a corner lot, the frontage is measured from the side lot line to the midpoint of the arc that constitutes the corner rounding at the intersection of the two streets.

Full-Cutoff Light Fixture – A light fixture that casts little or no light upward.

Gable – The vertical surface that connects two or more sloped roofs. The triangular shaped wall section formed by the two slopes of a roof.

Ground Floor - That building floor which is substantially level with the exterior grade of the lot at the main entrance to a structure.

Human-scaled – The proportional relationship of a particular building, structure or streetscape element to the human form and function.

Impervious Surface – Material or structure on, above, or below the ground that does not allow precipitation or surface water to penetrate directly into the soil.

Landscaped Area – The part or parts of a lot developed and permanently maintained in grass and other plant materials, in which the space is open to the sky and is free of all vehicular traffic, parking, loading and outdoor storage.

Landscape Maintenance Plan – A document that describes the intentions and specifications for maintaining landscape to be installed as part of a development including pest management, irrigation, fertilization, mulching, pruning, staking and seeding requirements to establish and enhance the health of installed landscape.

Lot – A single area of land in one ownership defined by bounds or boundary lines in a recorded deed or shown on a recorded plan.

Lot Frontage – The length of a lot line(s) measured at the street right-of-way line.

Lot Line – A line of record bounding a lot that divides one lot from another lot or from a way or any public space.

Lot Line, Front – A lot line separating a lot from a street right-of-way.

Lot Line, Rear – A line separating a lot from other lots or from land in a different ownership, being the boundary of a lot which is opposite or approximately opposite the front lot line.

Lot Line, Side – Any lot line other than a front or rear lot line.

Low Impact Development (LID) – A term used to describe land planning and engineering design approaches that manage stormwater runoff with an emphasis on conservation, use of on-site natural features, and the protection of water quality.

Massing – The overall form of a building, its physical bulk and volume as it relates to the site.

Monument Sign – A sign, other than a pole sign, with a lower overall height in which the entire bottom is in contact with or close to the ground, independent of any other structure.

Multi-Tenant Development – A group of two or more establishments located in one or more buildings on one or more lots of land under single or multiple ownership, that is designed, planned, constructed or managed as a single entity, with customer and employee parking provided on-site. This includes but is not limited to what is commonly understood and recognized to be a shopping center, office park, or industrial park.

Neck-Down – Also, referred to as a curb extension. A traffic calming measure that extends the curb into the street at an intersection to reduce the pedestrian crossing distance.

Parapet – A low wall or railing that extends above the roof of a building.

Pedestrian-oriented – Describes an approach to circulation or accommodation in which the pedestrian is the primary consideration.

Pedestrian-scale – The relationship between an individual and his or her environment whether natural or built which contributes to an individual's comfort and sense of accessibility.

Pier - An upright support for a superstructure, such as an arch or bridge. Specific to facades, it often refers to a raised column-like element used to frame windows or bays.

Planning Board (PB) – The Planning Board is the approving authority that that reviews subdivision plans, applications for certain special permits and other site plans for future development for consistency with the *2020 Winchendon Comprehensive Master Plan and Site Plan Rules and Regulations*.

Projecting Sign – A sign, other than a wall sign, affixed to a building or wall in such a manner that its leading edge extends more than eight inches beyond the surface of such building or wall. Projecting signs include but are not limited to awning/canopy sign, banner, marquee sign and suspended sign. Projecting signs are also referred to as blade signs.

Roof – The primary outside protective covering of the top of a building. This includes but is not limited to hip, gable, flat, gambrel, mansard, and shed roof types. Roof shall also mean the exterior protective covering affixed to the top of all other elements projecting from a building façade or its roof including but not limited to porches, dormers, or other similar appurtenances.

Setback – The distance between a structure and any lot line.

Sign or Signage – Any object, design, device, display or structure intended for public view from outside a building, used by a private or public entity to identify, announce, advertise or direct attention to any place or location, object, business, institution, organization, profession, merchandise, product, activity, service, event, person, idea or statement, or to communicate information of any kind to the public by any means including words, letters, figures, designs, pictures, symbols, fixtures, colors, and illumination. Sign shall mean and include any permanent or temporary structure, models, objects, banners, pennants, insignias, trade flags, or other representations that are on a public way or on private property within public view from a public or private street, way or parking area. Any exterior structural surface that is internally or indirectly illuminated or decorated with gaseous tubes or other lights shall be considered a sign.

Site Plan – A scaled illustration depicting the planned layout of buildings, parking, driveways, sidewalks, landscape, stormwater facilities and other features of the lot. The site plan is one element of the required information of a site plan submittal or application.

Street – See definitions below:

- A public way or way which the Town Clerk certifies is maintained and used as a public way.

- A way shown on a definitive subdivision plan approved and endorsed under the Subdivision Control Law and recorded with the Norfolk County Registry of Deeds that is constructed or secured through a covenant or suitable performance guarantee.
- A way already physically in existence on the ground when the Subdivision Control Law become effective in Winchendon and having, in the opinion of the Planning and Economic Development Board, adequate width, construction, and grades for the needs of vehicular traffic for the existing and future buildings and uses abutting thereon or to be served thereby.

Street ROW Line – A lot line separating a lot from a street right-of-way.

Streetscape – The collection of elements that constitute the physical makeup of a street and that, as a group, define its character including building frontage, street paving, street furniture, landscaping, open space areas and lighting.

Structure – Anything constructed or erected at a fixed location on the ground to give support or to provide shelter.

Vista – A unique view to or from a particular point through a passage or opening in a feature of a building or site.

Wall Sign – A sign which is permanently affixed to the façade of a building or structure, or to its porch, canopy, awning, such that its exposed face and all sign surface areas are parallel or approximately parallel to the plane of the building or wall to which it is attached or mounted.

Wayfinding – Wayfinding signage refers to a family of signage products created for the purpose of directing people to & from a defined area, all while guiding them through paths, marking destinations reached, and providing both essential and commercial instructions and data along the way.

Yard – Any open space on the same lot with a principal building, unoccupied, and unobstructed from the ground to the sky, except for accessory buildings or structures, or such projections as are expressly permitted in zoning regulations. A yard lies between the principal building and the lot lines.

Zoning District – The basic unit in zoning. A portion of land in a community to which a uniform set of regulations applies, or a uniform set of regulations for a specific use.